



Leblanc illuminations

Creator of sustainable emotions

CANADA

OFFICE • +1 450 755 6902 • contact@leblanc-illuminations.ca
FREE CALL • +1 866 814 3617
SALES • +1 514 891 6902 • a.beauvais@leblanc-illuminations.ca

FRANCE

OFFICE • +33 (0)2 43 61 43 61 • contact@leblanc-illuminations.com
6-8 rue Michaël Faraday 72027 Le Mans Cedex 2 France
LOGISTICS DEPARTMENT • +33 (0)2 43 61 43 80 • leblanc.logistique@leblanc-illuminations.com
35 Boulevard Pierre Lefauchaux 72027 Le Mans Cedex 2 France
AFTER SALES SERVICE • +33 (0)2 43 61 43 61 • sav@leblanc-illuminations.com
Open monday to friday from 8.30 am to 12.30 am and from 1.30 pm to 5.30 pm.

MEXICO

OFFICE • contacto@leblanc-iluminacion.com.mx

UNITED KINGDOM

OFFICE • 01622 882424 • hello@galalights.com
INSTAGRAM @galalights • **TWITTER** @GalaLights • **FACEBOOK** @GalaLightsUK



ONLIGNE CATALOGUES

All our **products** and **all our know-how** can be found in our updated catalogues and brochures.

LEBLANC ILLUMINATIONS, CREATOR OF SUSTAINABLE EMOTIONS



Illuminating hearts, sublimating spaces.

Since 1958, Leblanc illuminations has been bringing magic to our towns and cities. Year after year, our mission remains the same: to create unique illuminations that are a source of emotion and wonder.

With this new catalogue, we invite you to explore a world where innovation meets poetry. Each creation is designed to combine aesthetics with respect for the environment, to offer lighting experiences that are as spectacular as they are sustainable.

In these pages, you'll discover new inspirations, ever more responsible materials and cutting-edge technologies that are redefining the art of illumination. More than just a catalogue, the White Paper is a promise of creativity and support to enhance your projects and make every moment shine.

Make light an art, and together we can create unforgettable moments.

Alexandra Petit & Rachel Net

Chief Executive Officer

Deputy Director General

LEBLANC ILLUMINATIONS

French company, international expertise

Leblanc Illuminations extends its global reach through four subsidiaries and a presence in more than 40 countries, supported by an extensive network of authorized distributors.

INTERNATIONAL TEAM



Alexandra Petit

Chief Executive Officer
Ph. +33 (0)2 43 61 40 86
contact@leblanc-illuminations.com



Rachel Net

Deputy Director General
rnet@leblanc-illuminations.com



Canada **Jean-François Hénault**

Chief Executive Officer
Ph. +450 755-6902
contact@leblanc-illuminations.ca



Mexico **Clément Briendo**

Chief Executive Officer
contacto@lbi.com.mx



Romania **Elena Heuripeau**

Chief Executive Officer
Ph. +33 (0)2 43 61 43 61
contact@leblanc-illuminations.com



United Kingdom

Christopher Stille

Chief Executive Officer
Ph. +44 1622 882424
hello@galalights.com



"Leblanc illuminations, one of our companies serving your creativity"



The Creative Show Industry Group of companies create, produce and feature at events and installations. The branded products and equipment we manufacture and supply, together with our bespoke services, allow you to carry out your project in its entirety with a guarantee of technical and artistic success.

Arnaud Leschemelle • President



Leblanc illuminations

The creator of the festive illuminations market in 1958, Leblanc illuminations has been working with cities, towns and shopping centres for over 65 years to bring to life bespoke projects, both in France and internationally. www.leblanc-illuminations.com

Arbiter France

The catalogue specialised in studio equipment and hightech products dedicated to music production : monitoring speakers, microphones, headphones, sound processing, sound and light products for DJs. www.arbiterfrance.com

Freevox

A dedicated catalogue of HARMAN Group brands (JBL, SOUNDCRAFT, AKG, etc.) to help audiovisual professionals get on 'the right track'. www.freevox.fr

Audiopole

The catalogue of professional audio equipment for broadcast (televisions and radios), touring (concerts, touring) and fixed sound systems such as conference rooms. www.audiopole.net

Starway

Discover the catalogue of our French brand STARWAY, manufacturer of LED spotlights for the events market. www.starway.eu

MEGA-HERTZ

Mega-Hertz

Mega-Hertz has been providing technical services for events for over 40 years, offering a complete range of services to deliver lighting, video, sound and the installation of scenic structures. www.mega-hertz.fr



Discover the Starway catalogue.

OUR BRANDS



Professional quality of lights

A French brand of cables and garlands since 1943, Chromex is the specialist in lighting equipment for cities and professionals. The brand combines the professional and technological quality of its products with great ease of use. Its product lines combine aesthetic design with low energy consumption.



The Twinkly Pro experience

- **Instant setup**

Place your Twinkly Pro string lights and download the app. Easily connect your device to Wi-Fi.

- **Scan our decoration**

The app is able to detect the exact position of every single LED through your smartphone camera.

- **Play with different effects**

Choose from a huge gallery of effects that can be fully customized by adjusting the speed, colors, and other settings for each animation.

- **Customize your animation**

You can easily design your own effects: draw your creations with your finger or download additional effects.



OUR BRANDS



Today's decorations are the raw materials for tomorrow's designs.

Leblanc Illuminations has invested in a fleet of 3D printing robots and developed **e-deco**, a range of **durable daytime decorations** that **do not require electricity**.

With its **4 materials and 13 dynamic, festive colors**, e-deco offers limitless creative freedom in design.

Our printed products are **manufactured in our own factory**. The raw materials are **biosourced, recycled, and recyclable**: at the end of their lifecycle, they are ground into new granules that will be **used to create new decorations**.



Watch the video



HALTO

by Leblanc illuminations



Dynamic architectural lighting

A French brand offering products for dynamic, architectural lighting: bars, spotlights, built-in lights, gobo projectors, and more. With over 30 years of experience, Halto creates long-lasting, colorful projects to enhance buildings.

halto.fr

LEBLANC ILLUMINATIONS WORLDWIDE

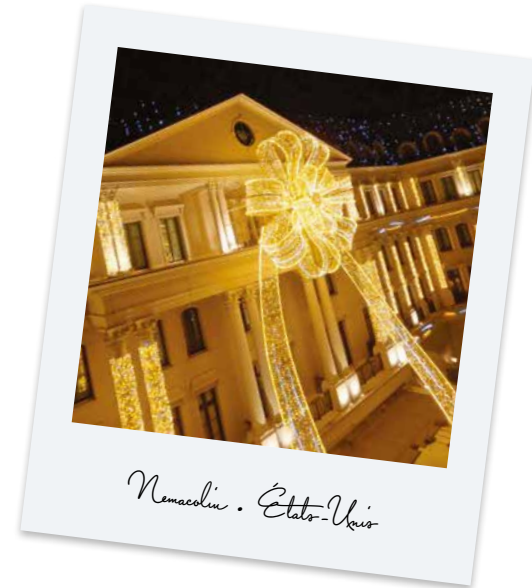

90
MILLION LEDS
light up per year

25,000
PLACES DECORATED
across the world

more than **40**
COUNTRIES
across the world



USA



Canada



Israel



Tahiti

They entrusted their projects to us

Miami Beach • Kourou • Marseille • Toulouse • Nouméa • Orlando • Mexico City • Bamako • Nantes • La Plagne • Richmond • Nice • Les Deux Alpes • Laval • NASA • La Clusaz • Annecy • Bruxelles • Montréal • Tahiti • Puebla • Las Vegas • Canterbury • Cannes • La Réunion • Monaco...

... And many others.

REQUEST OUR SEASONAL CATALOG

Each season has its own decor.

Leblanc Illuminations offers you with **e-deco** a range of products that can be adapted throughout the year to suit various events: the festive season, summer decorations, Pink October, Valentine's Day, sporting events, and more.

Dress you place for the season.

Online catalogs



SEASIDE



SEASONAL FESTIVITIES



PINK OCTOBER



SUMMER DECORATIONS

SEASONAL FESTIVITIES



1958

Founder of the lighting decorations market

Michel Leblanc created the Leblanc illuminations company in the Meuse region in France. He was the first to produce wooden decorations fitted with porcelain sockets

1960

FIRST ALUMINUM DECOR MANUFACTURER

Leblanc illuminations is the first player in its market to produce light decorations on an aluminum frame.

1982

FIRST TO ILLUMINATE THE CHAMPS-ÉLYSÉES

Leblanc illuminations is the first company to have illuminated the most beautiful avenue in the world.

1988

ROPE & ROLL

Rope light gradually replaces sockets in our light decorations.

1994

A ROYAL PLACE

Leblanc illuminations goes international with Gala Lights, our UK subsidiary.

1996

PIONEER OF LED

Leblanc illuminations anticipated the need for energy savings by being the first in Europe to include LED garlands in its illuminations.

2007

THE FAR NORTH IS OURS!

Leblanc illuminations Canada opens up and lets the Canadian snow shine.

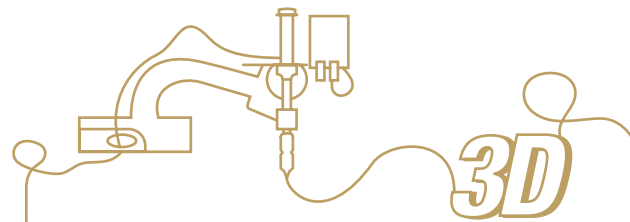

2015

3D PRINTING

Leblanc Illuminations innovates by using 3D prototyping.

2014

CONTROL YOUR ELECTRICITY CONSUMPTION

Thanks to our set control solution, programming the times and operating period for you illuminations, zone by zone, is simple and quick, with just a few clicks on your smartphone.

2014

ISO 9001 CERTIFICATION

Leblanc illuminations is the first company in its sector to be ISO 9001 certified.

2013

¡ VIVA ILUMINACIÓN !

Creation of the Leblanc Mexico subsidiary starting by the illumination of the town of Puebla and the Mazatlán shopping centre.

2010

LEBLANC TOUCHES HOSPITALS HEART

Leblanc illuminations and "Les Blouses Roses" have teamed up to offer hospitalised children and elderly patients a Christmas full of light every year.

2008

FIRST TO USE VIDEO FOR CHRISTMAS LIGHTS

Leblanc illuminations reinvents Christmas illuminations with the first animated and personalized 3D decor using video technology.

LET'S GO EAST

The base of our main production facility is founded. Leblanc illuminations România is created.

2015

AUTHENTIC PARTNERSHIP

Leblanc illuminations highlights Megève, this small internationally renowned village of the Savoy Region in the French Alps, and becomes its official partner in 2017.



2016

FRENCH SKI FEDERATION PARTNERSHIP

Signed an official 4 year partnership with the French Ski Federation and the French Ski Freestyle team, renewed until 2028.



2016

VIRTUAL REALITY

Virtual Reality, Augmented Reality, 3D Scanning – Leblanc uses new technologies which serve your imagination.

2017

A SCENT OF SUCCESS

Leblanc illuminations combines light and fragrance for a unique experience.

2019

LET'S SAVE CHRISTMAS

Between reality and the virtual world, Leblanc illuminations puts the user at the heart of illuminations.

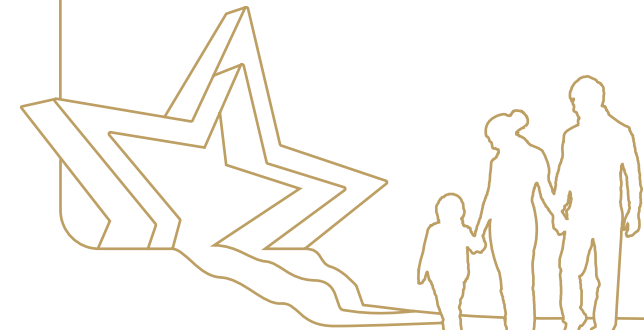



2023

A LEGENDARY CIRCUIT

Leblanc illuminations enjoyed breathtaking scenery and a grand celebration, as a partner at the 24 Hours of Le Mans race centenary.

2022

COQ VERT

To underline its commitment to ecological transition, Leblanc illuminations joined the Coq Vert Eco Community.



2021

GREEN REVOLUTION

This 3D printing process produces new and more sustainable daytime decorations.



2021

CSR 26000 CERTIFICATION

Leblanc illuminations becomes the most labelled company in its sector, with its CSR 26000 and ISO 9001 certifications.



2021

EXPERIENTIAL SHOW

Leblanc illuminations create a unique experiential light show: a new combination of architectural lighting, luminous decorations and lighting solutions.

2020

CONNECTED LIGHTS

Leblanc illuminations becomes a distributor of Twinkly Pro, a range of smartphone-controlled decors.



2024

HALTO EXPANDS THE FAMILY

The preferred partner of lighting professionals deploys its expertise to create exceptional lighting.

2025

LEBLANC SETS THE SCENE
In partnership with the NGO WeForest, Leblanc illuminations offsets its CO₂ emissions by supporting reforestation and ecological restoration projects to fight climate change.



THE MOST CERTIFIED MANUFACTURER IN ITS SECTOR

ISO 9001 & CSR 26000

Aware of social and environmental issues, the entire Leblanc Illuminations team is more committed than ever to improving our products, reducing our environmental impact, and ensuring customer satisfaction.

This ongoing commitment is recognized through **ISO 9001 certification since 2014** and confirmed by the **CSR 26000 label, awarded in 2021 and renewed in 2023.**

In 2022, Leblanc Illuminations joined the Coq Vert community, initiated by BPI France, ADEME, and the Ministry of Ecological Transition, which brings together companies that prioritize climate challenges in their strategy. This is the result of long-term dedication from all our teams and investments in our production facilities.

We are the only French manufacturer that is:

- ISO 9001 certified
- CSR 26000 certified
- A WeForest partner
- A member of the Coq Vert community
- **Manufacturing in France & Europe without subcontracting**

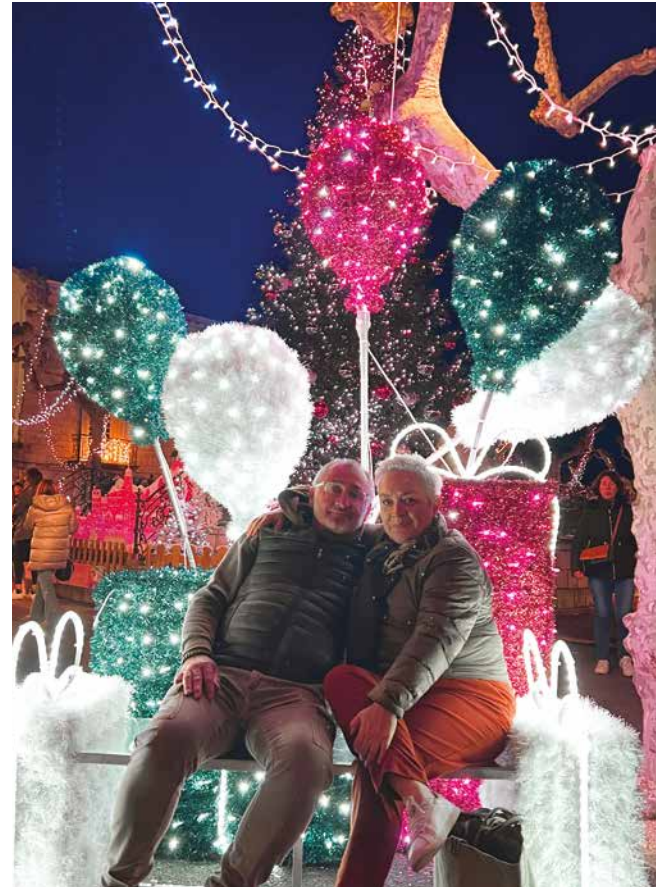

We are proud to be the most certified company in our sector!

WITH WEFORREST, A STRONG COMMITMENT TO THE CLIMATE



From 2025, Leblanc illuminations is strengthening its commitments.

We are proud to announce our dedication to **the fight against climate change**. In partnership with the NGO WeForest, we offset our CO₂ emissions by supporting reforestation and conservation projects in Tanzania and Peru.

These initiatives have a multiple and lasting impact:

- **On nature:** by restoring ecosystems, increasing biodiversity, and enhancing forest resilience.
- **On local communities:** by creating economic opportunities, improving living conditions, and strengthening rural communities.
- **On the climate:** by absorbing atmospheric carbon and helping to limit global warming.

Our approach is part of a long-term vision — one that combines sustainable development with environmental responsibility to build a better future for all.

LIGHTING UP THE HEART OF CITIES

Illuminations bring joy to people and boost economic activity. At Leblanc illuminations, we understand that a collective effort is needed to reduce energy consumption. We offer solutions to make the holidays both magical and responsible.



An energy-saving approach

As a partner of local authorities and professionals, we advise our customers on how to reduce their energy consumption and costs. We have been using **LED technology** since 1996, and today, **100% of our decors** are equipped with LEDs, reducing the power consumption of illuminations by more than 90%.

Innovative Solutions to Optimize Consumption

To go further, in 2014 we developed **a remote control box** manufactured in France. Linked to an app, it allows decorations to be lit only during certain times of the day, offering **optimal control** and significant savings.

Local and Eco-Responsible Manufacturing

All our decorations are designed in-house, following **French expertise**, ensuring sustainability and environmental control. We prioritize recycling principles: **reducing** emissions and plastics, **reusing** raw materials, and **managing waste** in our workshops.

Better informing our customers

about the power consumption of our equipment is part of the service we provide, helping to guide your choices.



Quality and tranquillity

Our teams are constantly seeking eco-responsible solutions that will allow a reduction in plastic use and carbon footprint of our products, while improving their performance and sustainability.

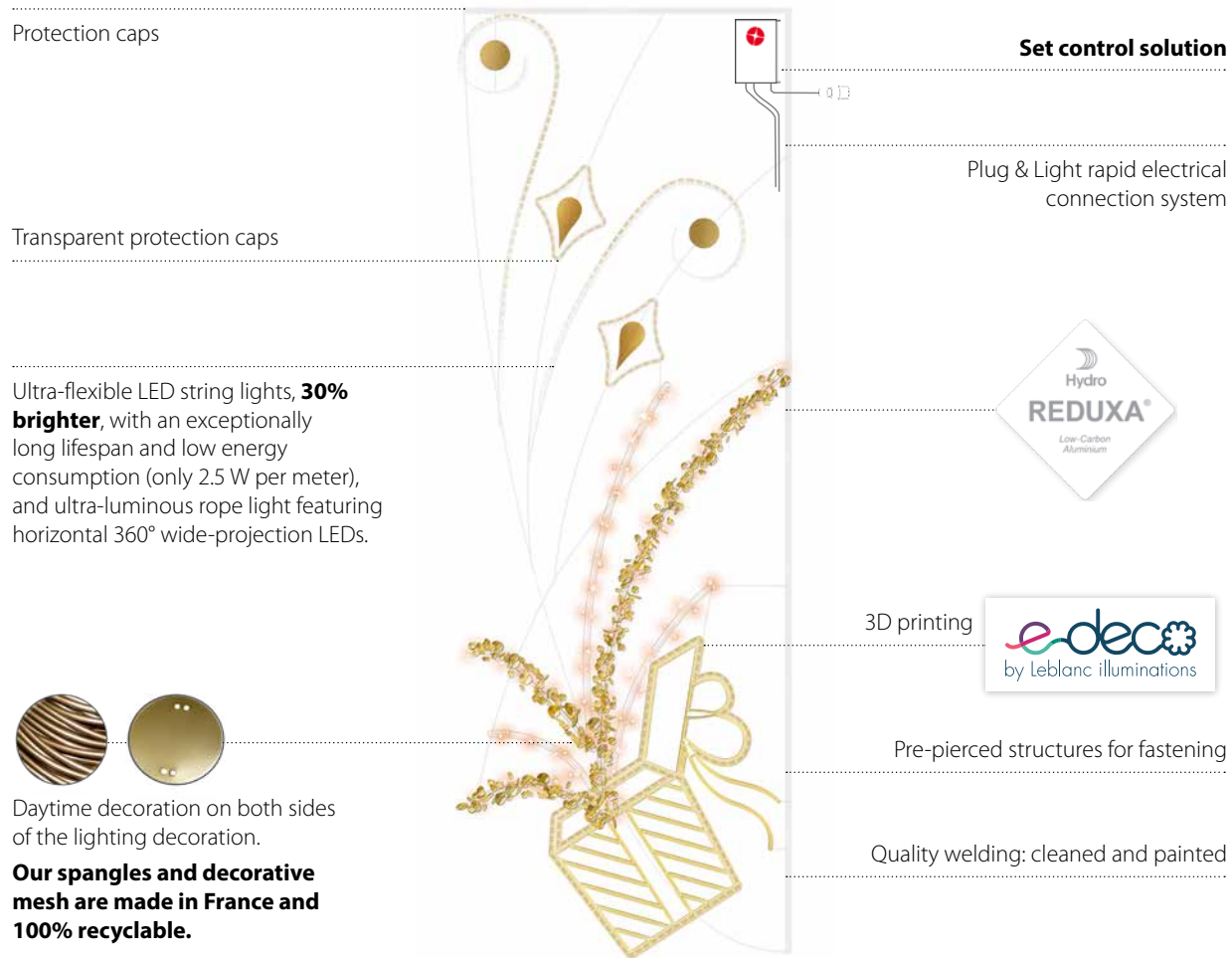

e-deco by Leblanc

Innovative materials, optimised energy consumption, new production methods: we are transforming our business to offer you products suited to the demands of sustainable urban life.

50% electricity saving

thanks to the patented technology, developed by our teams, simply by controlling the illuminations' light-up time.

Hydro REDUXA Aluminium

This is an aluminium with a low environmental impact, produced using renewable energy. **100% of the aluminium** frames returned to us at the end of their lifecycle are repurposed into new decorations or products.

LEBLANC ILLUMINATIONS, FRENCH KNOW-HOW

From order to delivery



As a French Tech company, we are always proud to support jobs with manufacture in France, participate in the economic development of the country and export French know-how.

A well conceived project

Our creative and technical teams imagine the style and feasibility of your project while ensuring the scheme conforms with the necessary safety regulations, under the watchful eye of our in-house test centre.

100% made in Leblanc

Leblanc illuminations has the largest lighting decoration manufacturing factory. It brings together all the expertise required for **high-quality production.**

Logistics at your service

Shipments dispatched as quickly as possible. **Daily deliveries nationwide and internationally.** 20,000 m² of storage space.

Responsive quality and after-sales service

Systematic checks at every step of the process ensure quality service. Leblanc illuminations guarantee your **new products for 2 years.**

COMMUNITY & BEST PRACTICE

*We are passionate about our work and aim to develop solid and responsible relationships with our partners.
Our good customer service and after sales care set us apart.*

Taking care of our teams, our clients, and future generations

Leblanc Illuminations is committed to operating in a socially responsible manner. In 2020, we formalized our commitments and expectations in a Responsible Purchasing Charter, shared with our partners.



Commitment charters

We have developed a CSR Commitment Charter intended for our employees and stakeholders and a Responsible Purchasing Charter for our complete supply chain.



Encouraging recycling and local purchasing



Annual client satisfaction surveys



Employees

Identifying development opportunities for our employees.



Defending the diversity of our teams

100% of our employees have signed our charter for the promotion of equal opportunities

PARTNERSHIPS

Feel the thrill of Ski Cross !

Already a partner of **French ski resorts, the French Ski Federation and the French Ski Cross Team since 2016**, we have renewed our partnership **until 2028** to experience even more sporting emotions!



megève

Leblanc as snow

We were looking for a place that embodied history, architectural heritage and **the French art of living**, nestled in the heart of the Alps. With its 445 km of slopes, hotels, typical chalets and shops, we have found it: Megève, an authentic and renowned Savoyard village.

Since 2017, Leblanc Illuminations has been proud to be the official partner of the Megève illuminations. Every year, more than **5,000 spectators** gather for the inauguration of the legendary tree on the church square.

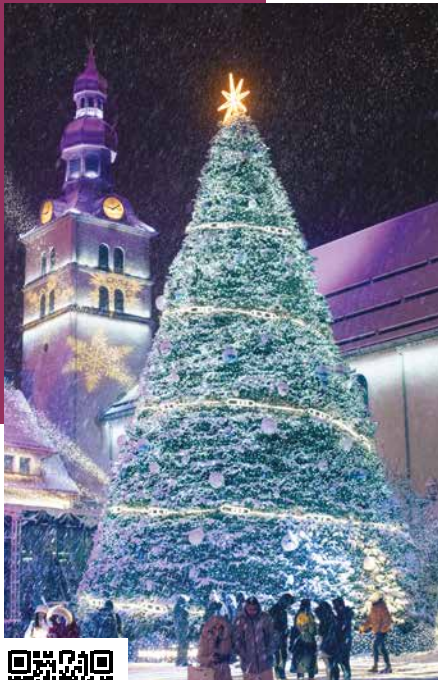

Watch the video

Star Academy

Exceptional event!

Leblanc illuminations, in collaboration with **BS Technology**, has been lighting up the emblematic castle of Star Academy, the famous French singing competition show, for the past 2 years. Leblanc illuminations used lighting equipment from its **Chromex** brand.



Watch the video

Dammarie-les-Lys • France

CORPORATE SUPPORT & SPONSORSHIP



THE BLOUSES ROSES ASSOCIATION

The mission of The Blouses Roses, created in 1944, is to bring comfort, listen to and entertain people who are sick, elderly or disabled, by means of entertainment.

www.lesblousesroses.asso.fr



The magic of Christmas in the hospital!

The end-of-year celebrations reflect sharing and generosity. For nearly 15 years, to bring smiles to both young and old, Leblanc illuminations and Les Blouses Roses have been partnering together. Together, we bring hospitalized patients a Christmas full of lights by decorating their places of care.

Already, 49 hospitals are illuminated in the colors of Les Blouses Roses each year.



Meet Ubi

Here is Ubi, an adorable ball of fur in training to become **a legal assistance dog** thanks to the commitment of Sylvie Pigeard, Sales Assistant. Selected by Handi'Chiens, Ubi undergoes **16 months of training** to provide moral support to people who consider themselves victims of criminal offences. Its presence illuminates our offices, reminding us of the benefits of animals at work. **Thank you to Sylvie for her dedication!**

Leblanc illuminations is committed to its employees

In 2022, Leblanc illuminations created the "Leblanc Sponsoring" commission **to support the company's employees who are involved in sports and associative projects.**

The Lapland Trophy!

Behind this title were **Solène and Nadège**, two employees of Leblanc Illuminations who went to **Finland** for a 3-day **solidarity sports adventure** in extreme conditions: running, snowshoeing, icemad, cross-country skiing, and orienteering on magical snowy courses! We were extremely **proud of their performance.**



The Rallye Aïcha des Gazelles du Maroc

A women's car competition focused on navigation and orientation rather than speed, with the aim of crossing the Moroccan desert with the help of a compass and a topographic map, without GPS. It is therefore quite natural that the company wanted to accompany Audrey, our South-East/Corsica sales manager, in this great adventure.

OUR SHOWROOM IN LE MANS

Awaken the senses with immersive experiences!

Leblanc illuminations presents an immersive light show in its showroom in Le Mans. Similar to the programs we offer to local authorities and businesses, the sound and light show transports the spectator into a magical universe that captivates both young and old!



Request your invitation

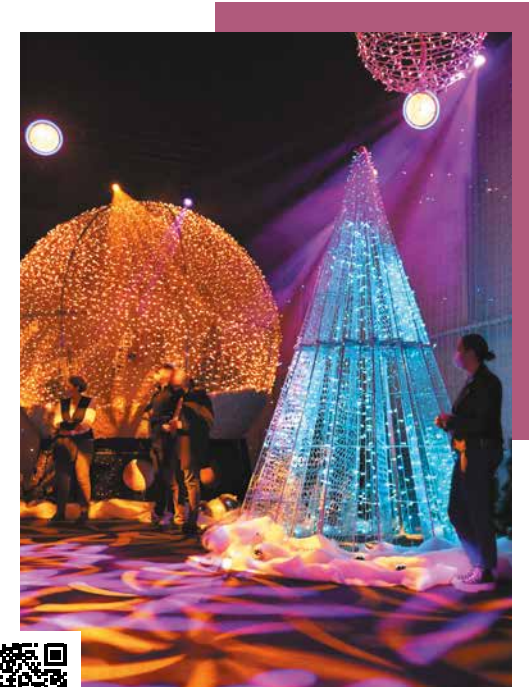

Watch the video

COMING SOON

Come and visit our new showroom.

Discover a preview of new atmospheres,
powered by a sound & light show and more...

PRESTIGIOUS DISPLAYS

A magical tree in Beaugrenelle Paris

Our expertise has brought to life a unique tree, which has become the center of attention in the gallery thanks to a combination of light and technological innovations. This project was carried out in partnership with **Mr. Bruno Dolis**, whose vision made it possible to design a magical universe within the gallery. We developed **automated shows** that punctuate the day, blending sounds, lights, and connected scenery to offer visitors an **immersive and unforgettable experience**.



Vivement Dimanche

For Christmas, we created the warm and **friendly atmosphere** of the **Vivement Dimanche television set**. Thanks to our installations, we added a touch of elegance and warmth, highlighting this iconic venue and providing viewers with a unique visual experience.



Cleveland Zoo • USA

Once again this year, we had the honor of lighting up the Cleveland Zoo for the Christmas holidays. Our light creations transformed the site into a **fairytale park**, offering a magical and unforgettable experience to visitors. We are proud to contribute to the magic of the holidays with our expertise.



Watch the video



Watch the video



Christmas magic at the Château de Vaux-le-Vicomte

Immerse yourself in the world of luminous tales.

This year, the Château de Vaux-le-Vicomte is transformed into an enchanted kingdom, where the tales of our childhood come to life under the lights. A unique scenography by **Leblanc illuminations / Twinkly Pro / BS Technology**, where innovation and heritage meet.

MEET YOU

Worldwide

Trade fairs and congresses

This year, many fairs and events facilitated enriching exchanges: the AMIF (Association of Mayors of Île-de-France) fair, the Congress of Mayors of Drôme, the SELAQ in Nouvelle-Aquitaine, in the Alpes-Maritimes, French Guiana, Martinique, and even as far as Croatia.

The Mayors and Local Authorities Exhibition, held annually in November in Paris, remains a must-attend event for local and regional stakeholders.



"The French Art of Living"

Our decorations shone during an **exhibition** in the magnificent salons of the Embassy of France in Austria. Organized by **Business France Österreich**, the event honored design, craftsmanship and innovation through a selection of exceptional French products.

Reports

Leblanc illuminations benefits from significant media visibility thanks to regular reports on prestigious French channels such as BFM Business and M6. This television exposure, along with coverage across the world — France, Austria, Guyana, Martinique, Croatia, and more — confirms its reputation in the field and highlights its commitment to excellence.



Watch the video



Quiet on set at Leblanc illuminations!

We welcomed a **film crew** from OpenMédias/BFM TV to our premises in Le Mans. Leblanc Illuminations was approached to be featured in an episode of the report series "**Entreprises d'avenir**," available on **BFM's digital platforms**.

The team, consisting of a journalist and a videographer, captured footage in various areas of the factory and conducted a series of interviews.

OUR NEW MAGAZINE

Enter the world of Leblanc illuminations by leafing through the pages of its magazine *We LOVE lights.*
We are creators of sustainable emotions, we are inspired by your imagination to carry out your most beautiful illumination projects.



Online Magazine

SOCIAL MEDIA



Join us

on our many social media channels, where we regularly share content that **reflects the unique spirit of Leblanc illuminations.** Recently, we've also joined **TikTok**, a platform where you can discover our **original, creative, and humorous videos.** Immerse yourself in our offbeat universe and let yourself be surprised by our different and daring vision!



- Expertise & achievements
- Reports & interviews
- Twinkly & e-deco

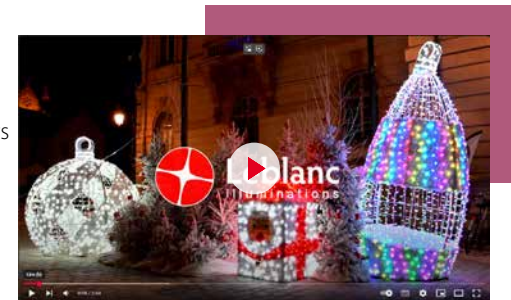

Content

Photo gallery

Our most beautiful achievements p. 23

Luminous decorations

My Traditional Christmas p. 42

My Crystalline Christmas p. 58

My Sumptuous Christmas p. 70

My Authentic Christmas p. 84

Decorations to install p. 96

Infinity decorations p. 158

Modular decorations p. 168

Our installations p. 178

Lighting solutions

Twinkly Pro range p. 188

Luminous garlands p. 196

Luminous boas p. 208

Ceiling lights p. 217

Icicle lights p. 220

Luminous suspensions p. 223

Branches, trees & floorstanding decors p. 238

Rope lights p. 242

Guinguettes garlands p. 252

Light bulbs p. 259

Plug & Light p. 266

Daytime decorations e-deco p. 272

Daytime decorations p. 276

Technological animations p. 283

Architectural lighting

HALTO by Leblanc products p. 292

Chromex & Starway products p. 297

Lumenradio products p. 298

Projects & services p. 299

Technical appendix

Standards and advices p. 304

Index p. 314



Gallery

Megève • France

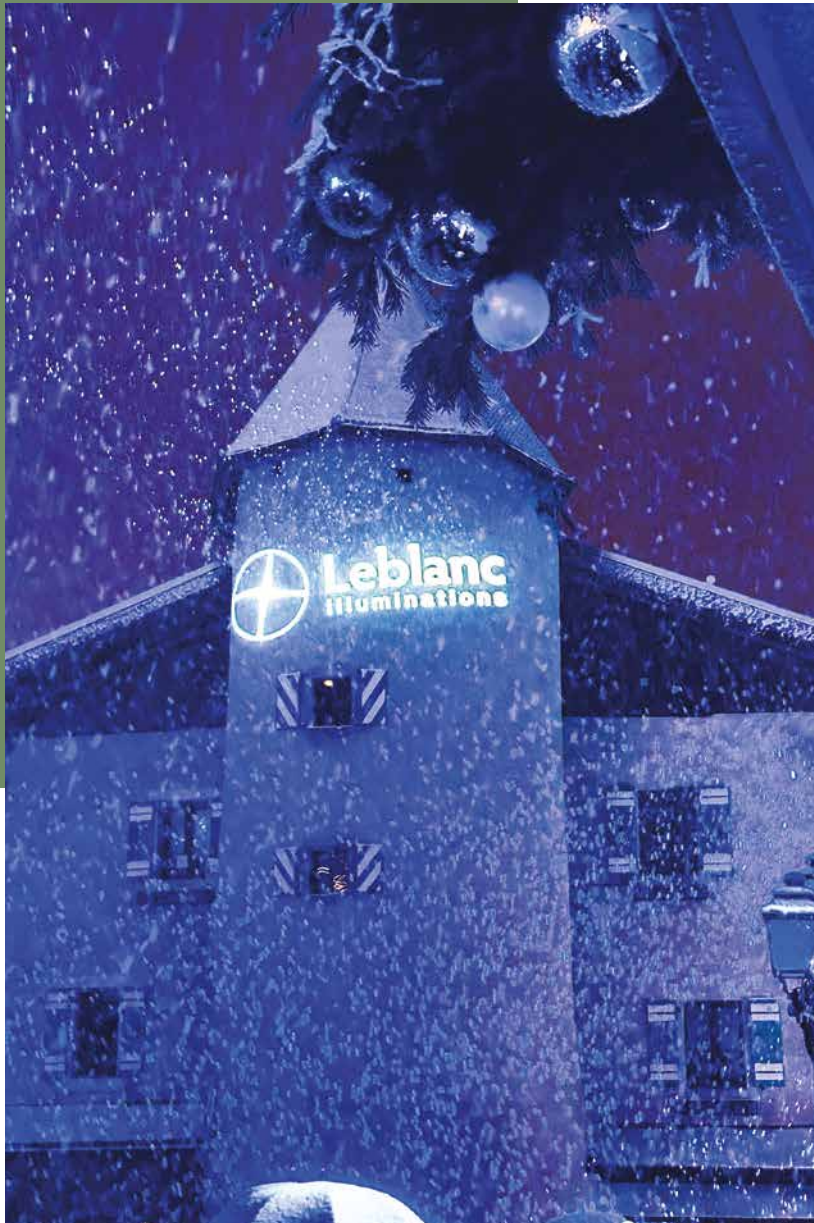

MEGÈVE, WHERE
LEBLANC SHINES LIKE SNOW



Megève • France





Megève • France

It's with pride that,

since 2017, Leblanc illuminations has been the official partner of Megève's Christmas illuminations. Every year, over 5,000 people gather to witness the inauguration of the legendary Christmas tree in the church square. This year, once again, Leblanc Illuminations contributes to the magic of Christmas with its illuminated tree, a central element of a spectacular sound and light show.



Once upon a time, there was the magic of Christmas in Laval...

Immerse yourself in a subtle blend of imaginary tales and the traditional Christmas of our childhood. During your walk, let yourself be guided by the candles hanging along the illuminated path. Adorned with garlands, gold and red baubles, and twinkling lights, the Aristide Briand Bridge will transport you into a true Christmas tale. The gingerbread castle, floating on the water, will evoke fairytale stories such as Hansel and Gretel, Cinderella, or The Nutcracker.



Laval • France

Design made in France



Behind the Scenes of the Design

Discover the development of the incredible Christmas lighting project for the City of Laval in 2024.

Follow the creation

Choice of colours and materials, construction of the aluminium structure, wiring of thousands of LEDs... Follow the imposing floating castle as it comes to life, step by step!

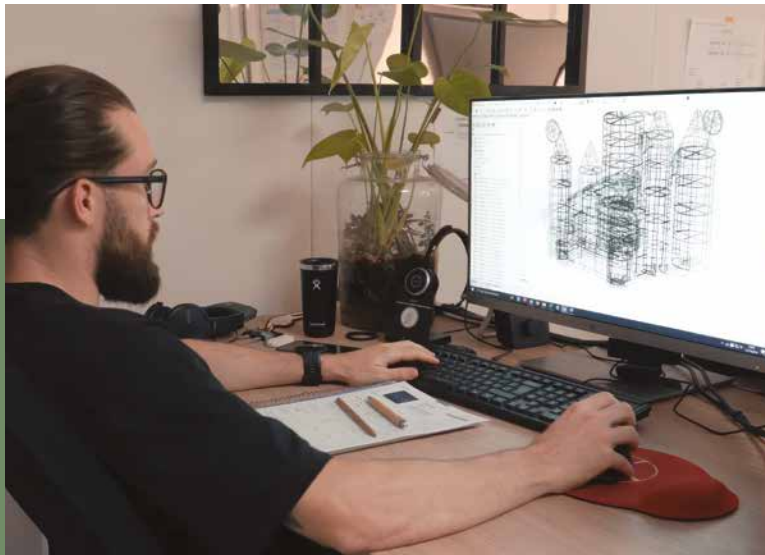

100% made by Leblanc illuminations



Our Le Mans workshops • France

Meet

the technical teams of the municipality and our talented partners on the ground during the installation of this impressive light project.

100% made by Leblanc illuminations



Laval • France

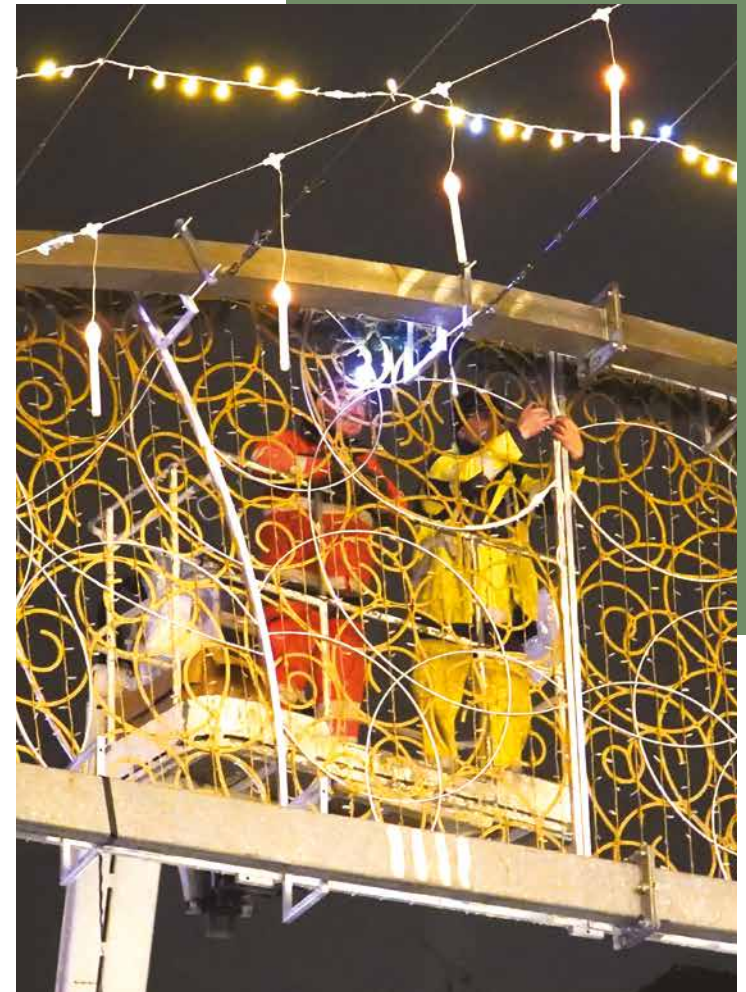

Laval • France

Monaco lights up elegantly.

From the Casino Square to the alleys of the Rock, golden garlands and refined decorations create a magical atmosphere. In the Place d'Armes, a majestic tree sparkles with a thousand lights, becoming the heart of this light show. A chic and sparkling Christmas that reflects all the prestige of the Principality.





Principality of Monaco



Principality of Monaco



CHRISTMAS & DELICACIES



Béziers • France

In the city of Béziers,

the delicacies attract all the locals, with an enormous gingerbread house decorated with colorful, vibrant candies. For Christmas, the town square is illuminated and filled with the scent of sweets. Children rush towards large, beautiful lollipops, as bright as they are tempting. Everyone realizes that the magic of Christmas lies in sharing and the joy of celebrating together, bringing warmth and happiness.



Sens • France



Sens • France



Bédarieux • France





Bulgaria



Carcassonne • France

Boisbriand • Canada



Laval • Canada

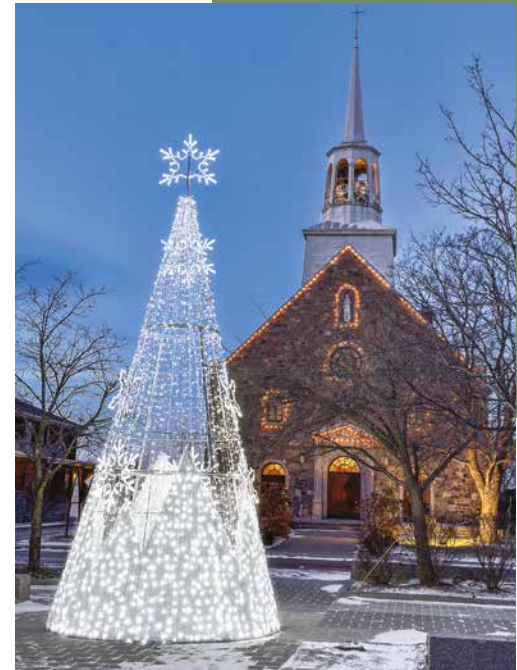

Caisse Desjardins Drummondville • Canada

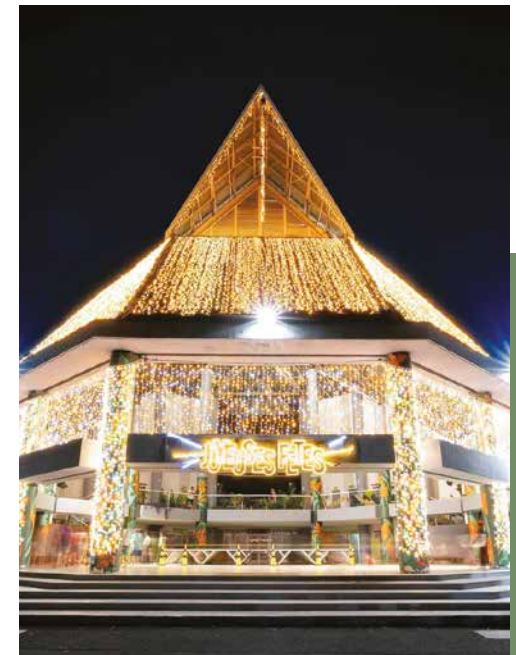

Punaauia • French Polynesia

Saint-Dizier • France



Saint-Dizier • France



Saint-Gilles • France

Châtelailion • France



Ludon • France



Le Port • Reunion Island

Infinity,

Leblanc illuminations revisits its iconic decorations through the Infinity Collection.

Play with an infinite and connected colour palette ! Discover your favorite decorations in their point-by-point controllable version without further delay.





Animated decoration



Chasing effect



Colorful declination



Confetti version also available



White/warm white Control



RGB Control



Dynamic animation
Cold White/Warm White/Amber



Dynamic animation
RGB/Warm white

For the majority of our range, luminous decorations can be placed horizontally and vertically. They offer a wide range of sizes, colours and animations. It is possible to combine our different collections with each other.

All our decorations are made with 100% LED, delivered with power cables & fastening kits, without bulbs and satellites. All our floorstanding 3D decorations are cabled in SELV, except for non-suitable products.



Luminous Decorations



GOLD



ENTER A WORLD OF DREAMS
AND DISCOVER
SANTA'S WORKSHOP





TOYS



My Traditional Christmas

Welcome
to an enchanted world
where wishes come true



XMAS TREE

*My Traditional
Christmas*







1

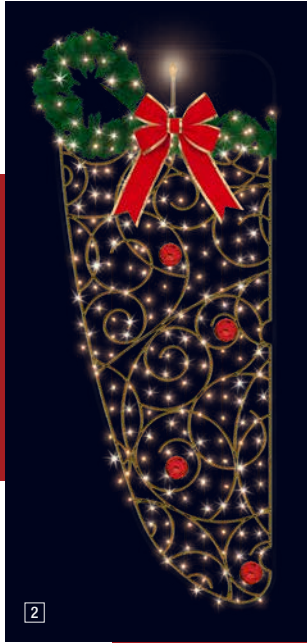

2



3



4



5



6

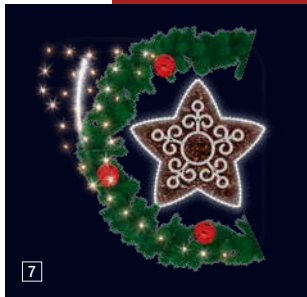

7



8



9



10

1 205527* AYDEN
2D Lamp column.
H:1 W:1 m.



2 205530* AYDEN
2D Lamp column.
H:2.5 W:1 m.



3 205490* ÉTOILE GOURMANDE
2D Suspension.
H:0.55 W:0.57 m.



4 205491* COURONNE
GOURMANDE
2D Suspension.
H:0.45 W:0.41 m.



5 205492* GINGER GOURMAND
2D Suspension.
H:0.53 W:0.45 m.



6 205496* CANNELLE + 205491*
2D Lamp column.
H:2.5 W:1 m.



7 205493* CANNELLE + 205490*
2D Lamp column.
H:1 W:1 m.



8 205498* CANNELLE + 205492*
2D Globe.
H:1.94 W:1.2 m.



9 205532* AYDEN
2D Suspension.
H:1.45 W:1 m.



10 205533* AYDEN
2D Globe.
H:2.38 W:1.2 m.



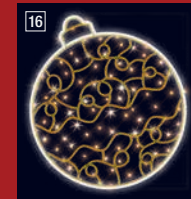

11 205535* AYDEN
2D Across street.
H:1 W:5 m.
❄️

12 205499* CANNELLE
2D Across street.
H:1 W:5 m.
❄️ Ⓞ

13 205534* AYDEN
2D Across street.
H:1.7 W:5 m.
❄️

14 204577 SOUPLE
DIAMANT 2
3D Across street.
H:0.8 W:5.2 m.
❄️

15 204578 SOUPLE
DIAMANT 1
3D Across street.
H:0.5 W:5.2 m.
❄️

16 204442 BOULE LUDIQUE
2D Lamp column.
H:1 W:0.9 m.
❄️ Ⓞ ● ● ●

17 204462 GINGER
LUDIQUE
2D Lamp column.
H:1 W:0.82 m.
❄️ Ⓞ ● ● ●

18 204437 CADEAU
LUDIQUE
2D Suspension.
H:1 W:0.8 m.
❄️ Ⓞ ● ● ● ●

19 205536* AYDEN
2D Across street.
H:0.65 W:2.7 m.
❄️

20 205537* AYDEN
2D Across street.
H:0.65 W:5.2 m.
❄️

21 205570* LUSTRE TRADI
3D Suspension.
H:2 W:1.6 D:1.6 m.
❄️

22 205569* LUSTRE
BOUGIES
3D Suspension.
H:0.66 W:1.7 D:1.7 m.
❄️

* NEW

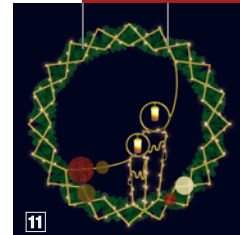
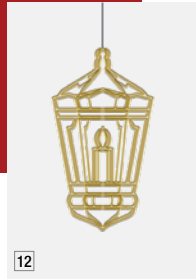
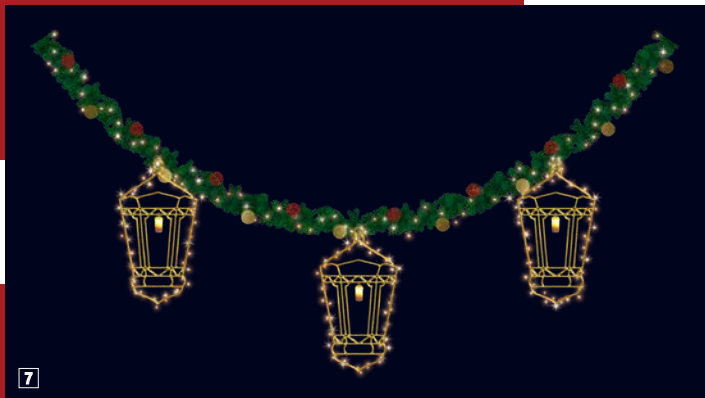
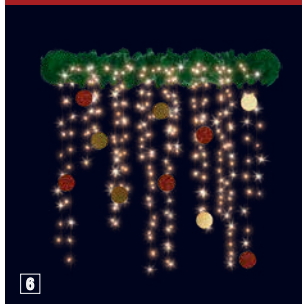
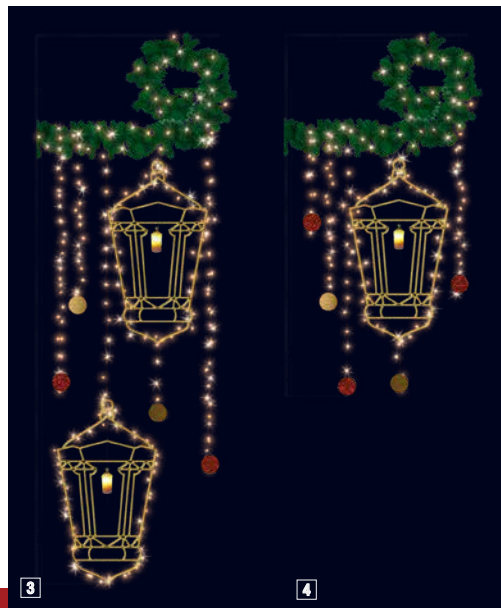
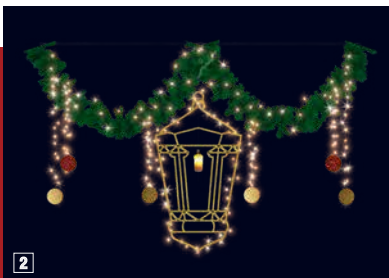
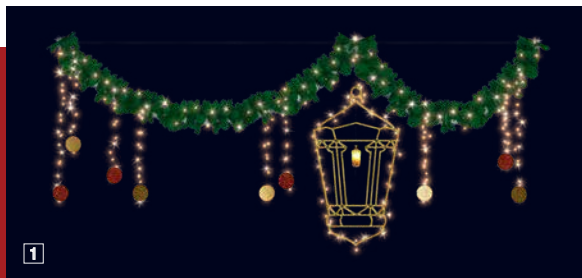

1 204502 LANTERNE
2D Across street.
H:1.3 W:3 m.



2 204501 LANTERNE
2D Across street.
H:1.3 W:2 m.



3 204498 LANTERNE
2D Lamp column.
H:3 W:1 m.



4 204496 LANTERNE
2D Lamp column.
H:2 W:1 m.



5 204499 LANTERNE
2D Suspension.
H:1 W:0.5 m.



6 204500 LANTERNE
3D Globe.
H:1.2 W:1.2 D:1.2 m.



7 204587 LANTERNE
2D Across street.
H:1.24 W:5.2 D:0.24 m.



8 203318 BOULE
2D Suspension.
H:1.15 W:0.95 m.



9 205571* LANTERNE
MELLOW
3D Suspension.
H:0.4 W:0.3 D:0.3 m.



9 204887 COURONNE
MERRY S
2D Suspension.
H:0.9 W:0.9 m.



10 204888 COURONNE
MERRY L
2D Suspension.
H:1.5 W:1.5 m.



12 170721 POP LANTERNE
3D Suspension.
H:0.5 W:0.27 D:0.27 m.



Non luminous

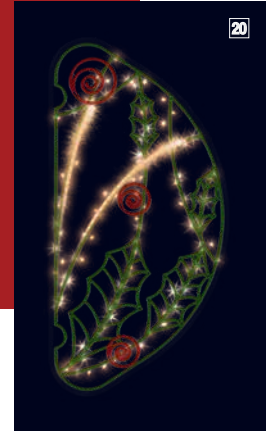
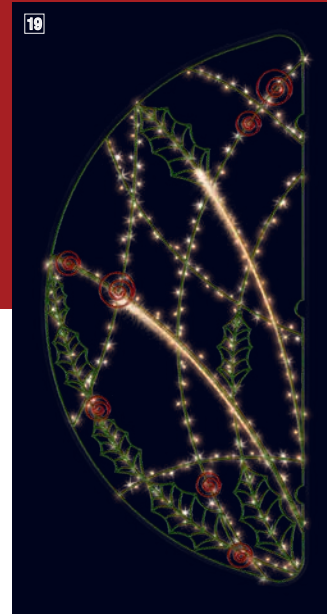
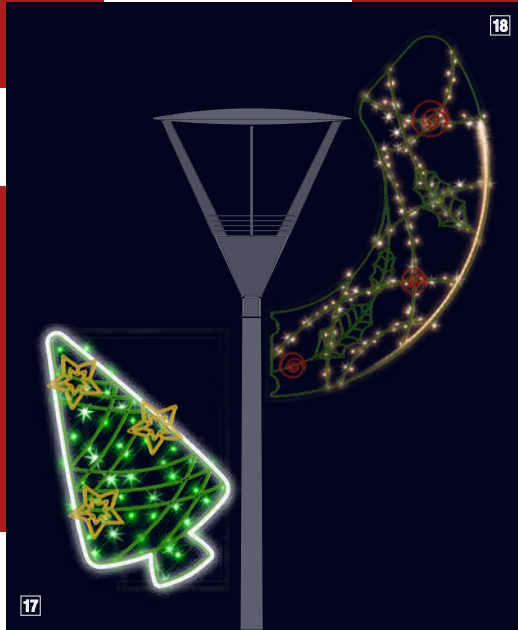
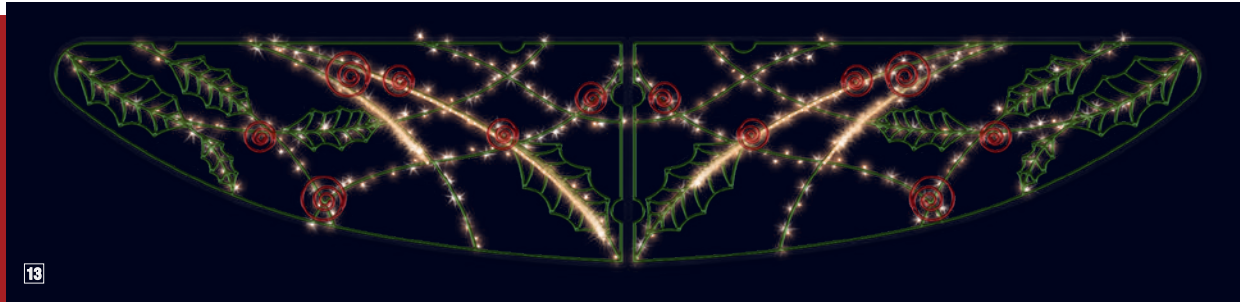

13 205221 HOLLY
2D Across street.
H:1 W:5 m.
☼ Ⓞ ● ●

14 205291 JOY
2D Suspension.
H:0.5 W:0.1 m.
Ⓞ ○ ○

15 205290 JOY
2D Suspension.
H:1 W:0.2 m.
Ⓞ ○ ○

16 205223 HOLLY
2D Suspension.
H:0.8 W:0.8 m.
☼ Ⓞ ● ●

17 204480 SAPIN LUDIQUÉ
2D Lamp column.
H:1 W:0.71 m.
☼ ○ ○ ●

18 205222 HOLLY
2D Globe.
H:2 W:1.2 m.
☼ Ⓞ ● ●

19 205220 HOLLY
Cand. & 2D Across street.
H:3 W:1.5 m.
☼ Ⓞ ● ●

20 205217 HOLLY
Cand. & 2D Across street.
H:1.5 W:0.75 m.
☼ Ⓞ ● ●

*My Traditional
Christmas*





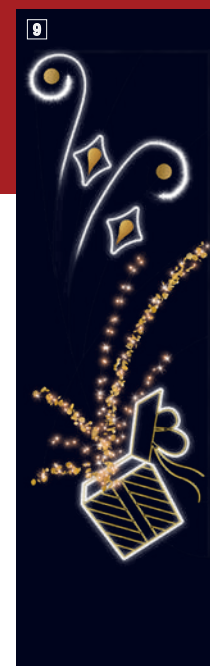
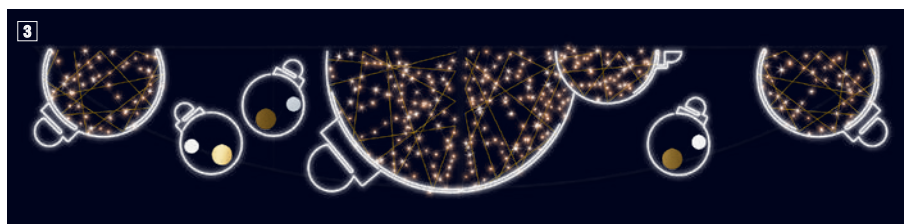

1 204532 ARCHE CADEAU
2D Across street.
H:2 W:6 m.
* () () () () ()

2 204530 CADEAU 2
2D Suspension.
H:1.15 W:1.15 m.
* () () () () ()

3 203319 BOULE
2D Across street.
H:1 W:6 m.
* () () () () ()

4 204534 JOYEUX
CADEAU 2
2D Across street.
H:1.4 W:5 m.
* () () () () ()

5 204877 NOËL FILANT
2D Across street.
H:1.5 W:5 m.
* () () () () ()

6 203420 MEILLEURS
VŒUX
2D Across street.
H:1.2 W:4.5 m.
* () () () () ()

7 203320 BOULE
2D Globe.
H:2.2 W:1 m.
* () () () () ()

8 203304 CADEAU
2D Globe.
H:2.2 W:1 m.
* () () () () ()

9 204529 CADEAU
2D Lamp column.
H:3.2 W:1.1 m.
* () () () () ()

10 203317 BOULE
2D Column & Across str.
H:3 W:1 m.
* () () () () ()

11 204531 CADEAU 2
2D Across street.
H:1.4 W:5 m.
* () () () () ()



12



13



21



14



16



17



18



19



20



12 **205638*** NOËLLA
2D Across street.
H:5 W:1 m.
☼ Ⓞ

13 **205636*** NOËLLA
2D Lamp column.
H:2.5 W:1.20 m.
☼ Ⓞ

14 205252 BOA CHIC
2D Across street.
H:0.8 W:6 m.
☼

15 205253 BOA CHIC
2D Across street.
H:0.5 W:6 m.
☼ Ⓞ

16 204882 COURONNE DE NOËL L
2D Suspension.
H:1.5 W:1.5 m.
☼

17 204881 COURONNE DE NOËL S
2D Suspension.
H:0.9 W:1.17 m.
☼

18 **205633*** NOËLLA
2D Lamp column.
H:1 W:0.5 m.
☼

19 **205632*** BOULE NOËLLA 3
2D Suspension.
H:1.06 W:0.43 m.

20 **205631*** BOULE NOËLLA 2
2D Suspension.
H:1.06 W:0.55 m.

21 **205630*** BOULE NOËLLA 1
2D Suspension.
H:1.06 W:0.54 m.

* NEW

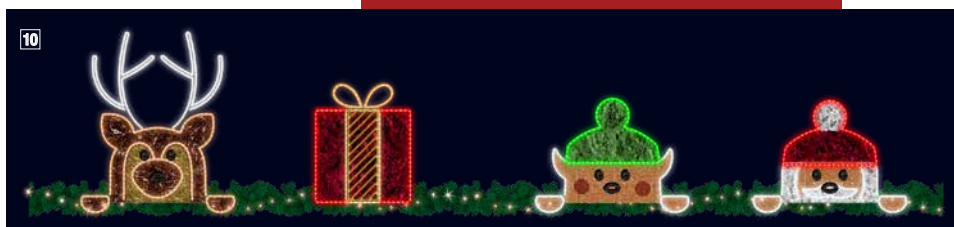
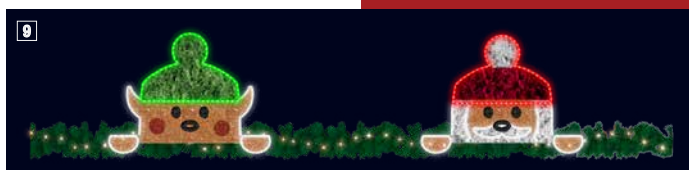
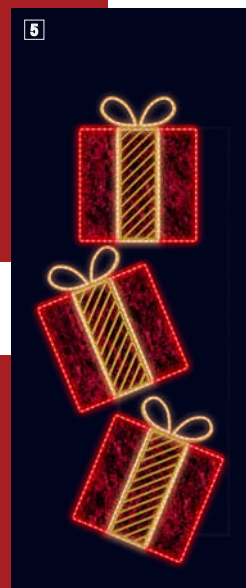

- 1 204492 FUNKY
2D Across street.
H:0.8 W:5 m.
☼
- 2 204476 CANDY
LUDIQUE
2D Suspension.
H:1 W:0.68 m.
●●●●
- 3 204490 CADEAU
FUNKY
2D Lamp column.
H:0.75 W:0.6 m.
- 4 204472 CANDY
LUDIQUE
2D Lamp column.
H:1 W:0.73 m.
●●●●
- 5 204489 CADEAU
FUNKY
2D Lamp column.
H:2.5 W:1 m.
- 6 204484 NEIGE
FUNKY
2D Lamp column.
H:1.6 W:0.85 m.
- 7 205500* GINGER
FUNKY
2D Lamp column.
H:1.58 W:0.8 m.
☼
- 8 204488 RENNE
FUNKY
2D Lamp column.
H:2.1 W:1.15 m.
- 9 204493 FUNKY
2D Across street.
H:0.75 W:4 m.
☼
- 10 204491 FUNKY
2D Across street.
H:1.2 W:6 m.
☼
- 11 204485 LUTIN
FUNKY
2D Lamp column.
H:1.6 W:0.75 m.
- 12 204486 PÈRE NOËL
FUNKY
2D Lamp column.
H:1.6 W:0.7 m.
- 13 204487 OURS
FUNKY
2D Lamp column.
H:1.65 W:0.8 m.

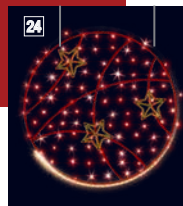
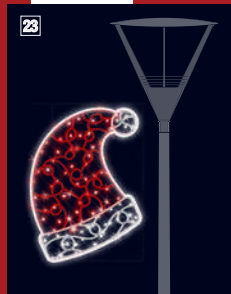
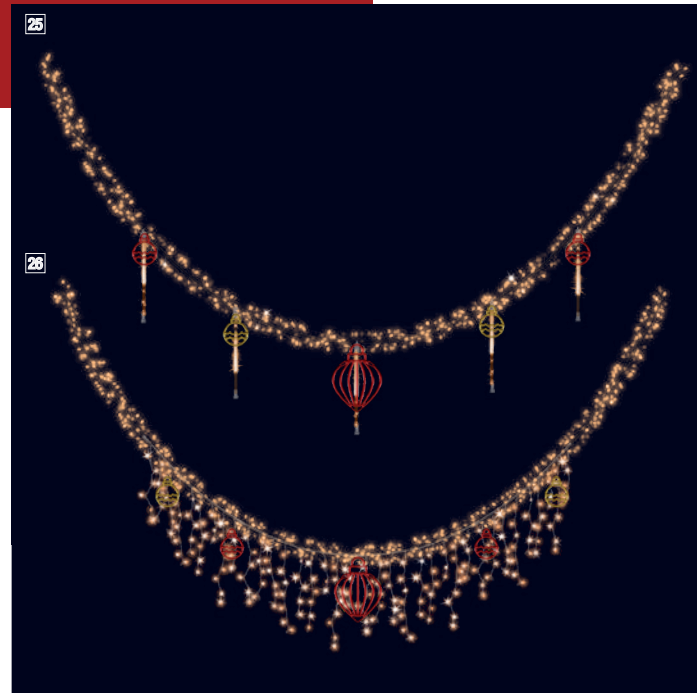
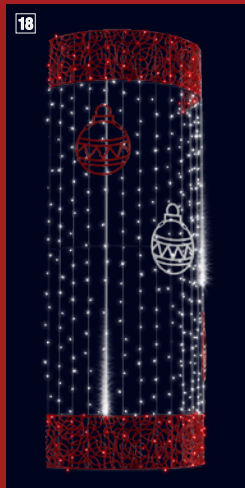

14 204345 MIRA TRADI
2D Lamp column.
H:1.5 W:1 m.
☼ ☉

15 204350 MIRA TRADI
2D Across street.
H:1.2 W:6 m.
☼ ☉

16 205566* LUSTRE
JOY ÉTOILE
2D Suspension.
H:1.2 W:1.08 m.
☼

17 205134 JOY ÉTOILE
2D Column & Across str.
H:1.5 W:1 m.
☼ ☉

18 205557* STARLIGHT
3D Lamp column.
H:2.5 W:1 D:0.5 m.
☼ ☉

19 205554* STARLIGHT
3D Lamp column.
H:1 W:1 D:0.5 m.
☼ ☉

20 205137 JOY ÉTOILE
2D Column & Across str.
H:3 W:1 m.
☼ ☉

21 170149 SPHÈRE
PLIABLE
3D Suspension.
Ø:0.55 m.
☼ ○ ● ● ●

22 204445 BOULE
LUDIQUE
2D Lamp column.
H:1 W:0.9 m.
☼ ○ ● ● ● ●

23 204455 BONNET
LUDIQUE
2D Lamp column.
H:1 W:0.72 m.
☼ ○ ● ● ● ●

24 205289 JOY ÉTOILE
2D Suspension.
H:1 W:1 m.
☼ ☉

25 205257 BOA TRADI
2D Across street.
H:0.5 W:6 m.
☼ ☉

26 205256 BOA TRADI
2D Across street.
H:0.8 W:6 m.
☼

* NEW



FROST

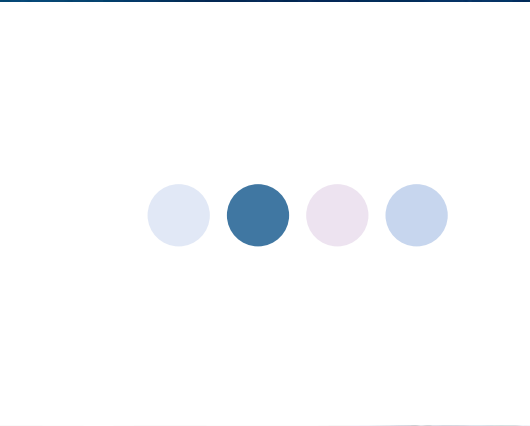

IMMERSE YOURSELF IN A FROSTY
XMAS, WHERE MAGIC FREEZES
TIME AND WARMS HEARTS.



SOFTNESS



My Crystalline Christmas

Wrap yourself
in the softness of the snow
for a memorable experience



SNOW

*My Crystalline
Christmas*







1 205254 BOA GIVRÉ
2D Across street.
H:0.8 W:6 m.
❄️

2 205255 BOA GIVRÉ
2D Across street.
H:0.5 W:6 m.
❄️ Ⓞ

3 204343 MIRA FLOCON
2D Across street.
H:1.5 W:6 m.
❄️ Ⓞ

4 204339 MIRA FLOCON
2D Lamp column.
H:2 W:1 m.
❄️ Ⓞ

5 205299 JOY FLOCON
2D Suspension.
H:1 W:0.2 m.
Ⓞ

6 204381 FROZEN
2D Across street.
H:1.15 W:5 m.
❄️ Ⓞ Ⓞ Ⓞ

7 205567* LUSTRE JOY
FLOCON
2D Suspension.
H:1.2 W:1.08 m.
❄️

8 205298 JOY FLOCON
2D Suspension.
H:1 W:1 m.
Ⓞ

9 205300 JOY FLOCON
2D Suspension.
H:0.5 W:0.1 m.
Ⓞ

10 204379 FROZEN
2D Suspension.
H:1.13 W:0.5 m.
❄️ Ⓞ Ⓞ Ⓞ

11 204380 FROZEN
2D Globe.
H:2 W:1 m.
❄️ Ⓞ Ⓞ Ⓞ

12 204376 FROZEN 3
2D Lamp column.
H:2 W:1 m.
❄️ Ⓞ Ⓞ Ⓞ

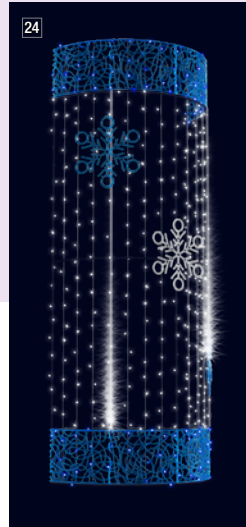
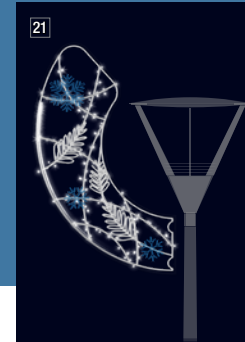
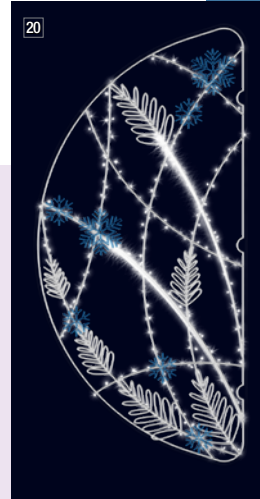
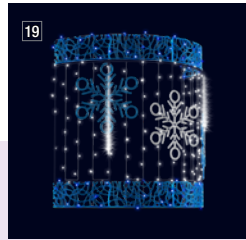
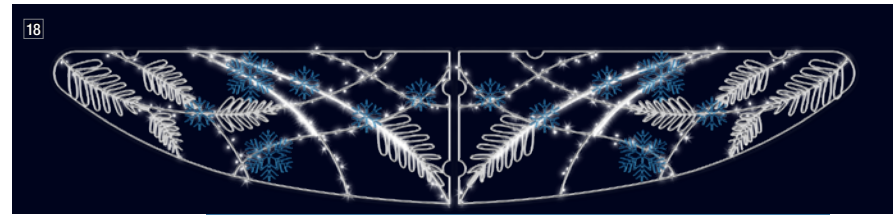

13 204580 SOUPLE
GIVRÉE 1
2D Across street.
L:5.2 Ø:0.24 m.
❄️ Ⓞ

14 204579 SOUPLE
GIVRÉE 2
2D Across street.
H:0.8 W:5.2 D:0.24 m.
❄️ Ⓞ

15 204585 SOUPLE
FLOCON 2
2D Across street.
H:0.8 W:5.2 D:0.24 m.
❄️ Ⓞ

16 204586 SOUPLE
FLOCON 1
2D Across street.
L:5.2 Ø:0.24 m.
❄️ Ⓞ

17 205243 GIVRE
2D Suspension.
Ø:0.8 m.
❄️ Ⓞ Ⓞ

18 205241 GIVRE
2D Across street.
H:1 W:5 m.
❄️ Ⓞ Ⓞ

19 205559* STARLIGHT
3D Lamp column.
H:1 W:1 D:0.5 m.
❄️ Ⓞ

20 205240 GIVRE
2D Column & Across str.
H:3 W:1.5 m.
❄️ Ⓞ Ⓞ

21 205242 GIVRE
2D Globe.
H:2 W:1.2 m.
❄️ Ⓞ Ⓞ

22 205152 JOY
FLOCON
2D Column & Across str.
H:3 W:1 m.
Ⓞ

23 205150 JOY
FLOCON
2D Column & Across str.
H:2 W:1 m.
Ⓞ

24 205562* STARLIGHT
3D Lamp column.
H:2.5 W:1 D:0.5 m.
❄️ Ⓞ

25 203293 SOUPLE
GLACÉE
2D Across street.
H:0.8 W:5.2 D:0.24 m.
❄️

* NEW

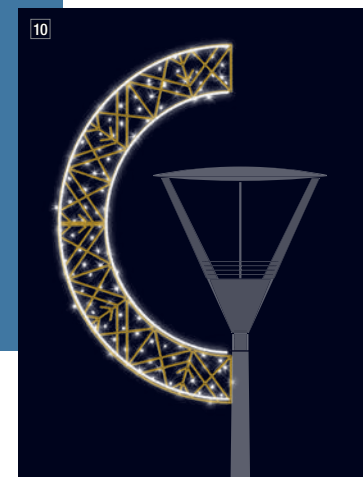
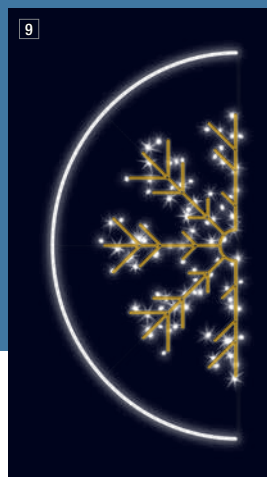
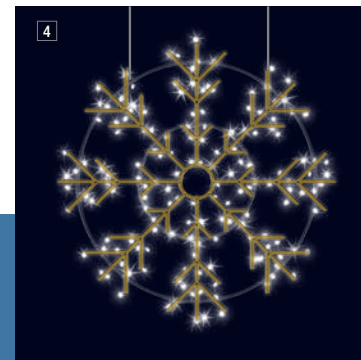
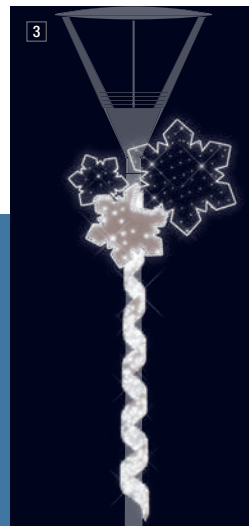
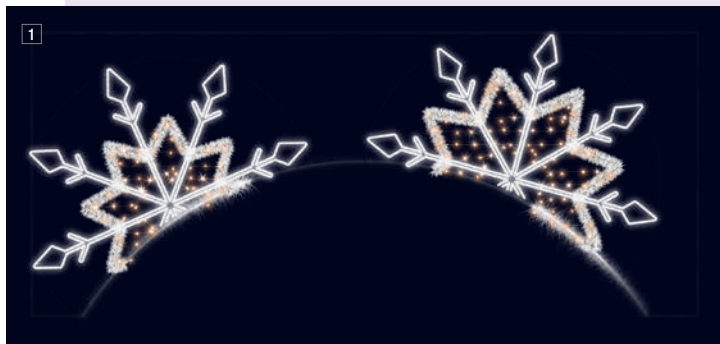

1 203387 ARCHE NEIGE
2D Across street.
H:1.7 W:4 m.
❄️ Ⓞ Ⓞ

2 205112 NORDIC
2D Column & Across str.
H:3 W:1 m.
❄️ Ⓞ

3 203383 RUBAN FLOCON
2D Lamp column.
H:4.95 W:1.5 m.
❄️

4 204215 FLOCON
2D Suspension.
H:1 W:1 m.
❄️ Ⓞ Ⓞ ●

5 205115 NORDIC
2D Suspension.
H:0.7 W:0.2 m.
Ⓞ

6 205109 NORDIC
2D Column & Across str.
H:1.5 W:1 m.
❄️ Ⓞ

7 205116 NORDIC
2D Suspension.
H:1 W:1 m.
❄️ Ⓞ

8 205114 NORDIC
2D Across street.
H:1 W:5 m.
❄️ Ⓞ

9 204211 FLOCON
2D Column & Across str.
H:1.5 W:0.75 m.
❄️ Ⓞ Ⓞ ●

10 204216 FLOCON
2D Globe.
H:2 W:1 m.
❄️ Ⓞ Ⓞ ●

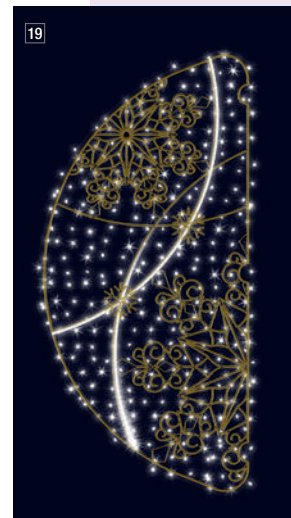
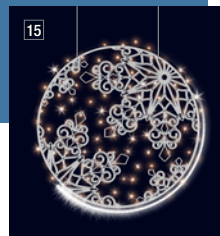
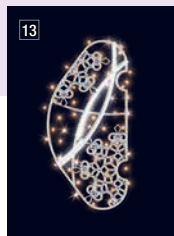
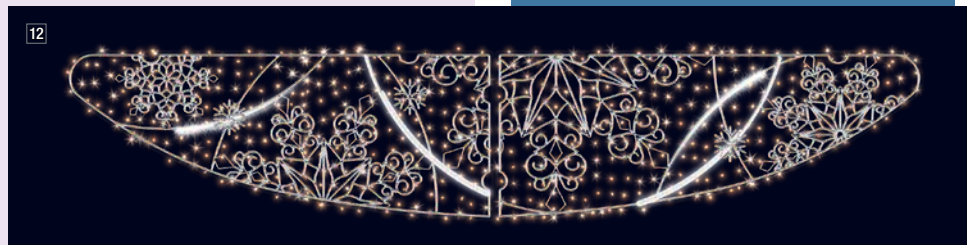
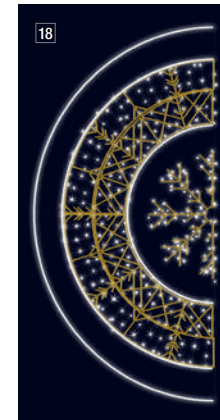
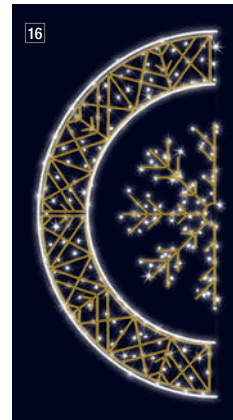

11 205507* SNOWY
2D Across street.
H:1 W:5 m.
❄️ Ⓞ Ⓞ

12 205514* SNOWY
2D Across street.
H:1 W:5 m.
❄️ Ⓞ Ⓞ

13 205508* SNOWY
2D Column & Across str.
H:1 W:0.5 m.
❄️ Ⓞ Ⓞ

14 205506* SNOWY
2D Suspension.
H:1 W:1 m.
❄️ Ⓞ Ⓞ

15 205513* SNOWY
2D Suspension.
H:1 W:1 m.
❄️ Ⓞ Ⓞ

16 204212 FLOCON
2D Column & Across str.
H:2 W:1 m.
❄️ Ⓞ Ⓞ ●

17 204220 FLOCON
2D Column & Across str.
H:2.5 W:1.2 m.
❄️ Ⓞ Ⓞ ●

18 204214 FLOCON
2D Column & Across str.
H:3 W:1.45 m.
❄️ Ⓞ Ⓞ ●

19 205504* SNOWY
2D Column & Across str.
H:2.5 W:1.15 m.
❄️ Ⓞ Ⓞ

* NEW

*My Crystalline
Christmas*





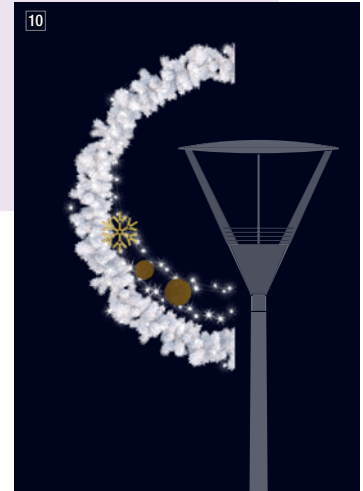
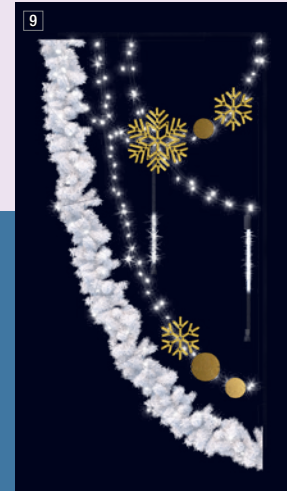
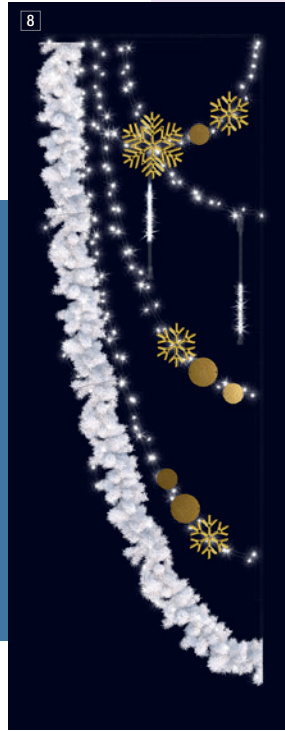
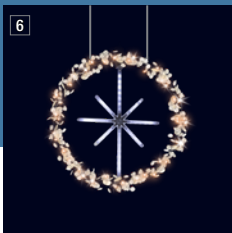
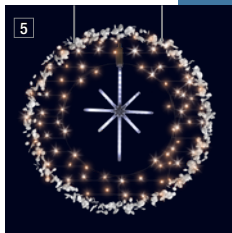
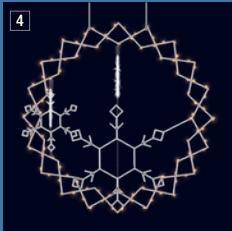
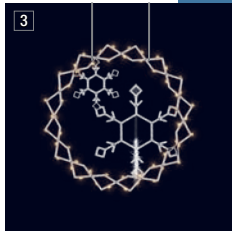
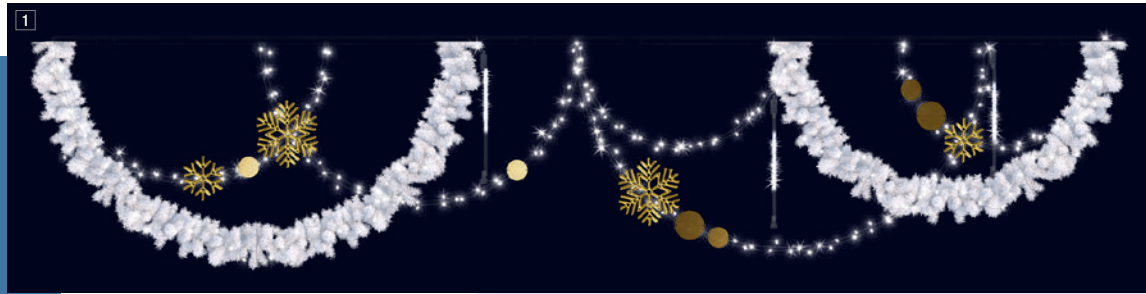

1 204525 WINTER
2D Across street.
H:1 W:5 m.
❄️ ⦿ ○ ○

2 204523 WINTER
2D Suspension.
H:1.13 W:0.28 m.
⦿ ○ ●

3 204885 COURONNE
GLACÉE S
2D Suspension.
H:0.9 W:0.9 m.
❄️ ⦿

4 204886 COURONNE
GLACÉE L
2D Suspension.
H:1.5 W:1.5 m.
❄️ ⦿

5 203279 COURONNE
GLACÉE
2D Suspension.
H:1 W:1 m.
❄️ ⦿ ○ ●

6 203280 COURONNE
GLACÉE
2D Suspension.
H:0.8 W:0.8 m.
❄️ ⦿ ○ ●

7 205247 ORIFLAMME
FLOCON
2D Column & Across str.
H:3 W:1 m.
❄️ ○ ○

8 204522 WINTER
2D Lamp column.
H:3 W:1 m.
❄️ ⦿ ○ ○

9 204520 WINTER
2D Lamp column.
H:2 W:1 m.
❄️ ⦿ ○ ○

10 204524 WINTER
2D Globe.
H:1.5 W:0.75 m.
❄️ ○ ○

11 203274 CRISTAL
2D Suspension.
H:1 W:1 m.
❄️ ○ ○

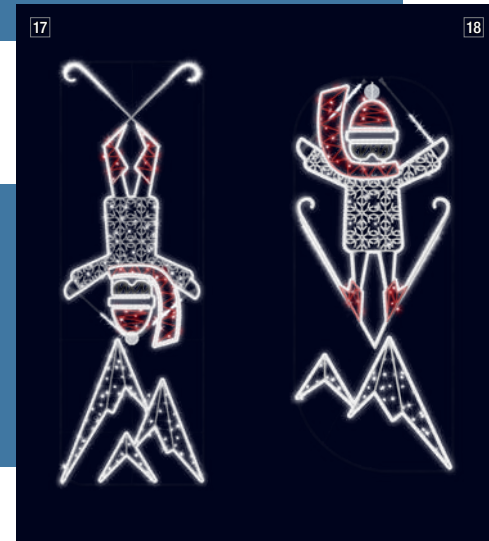
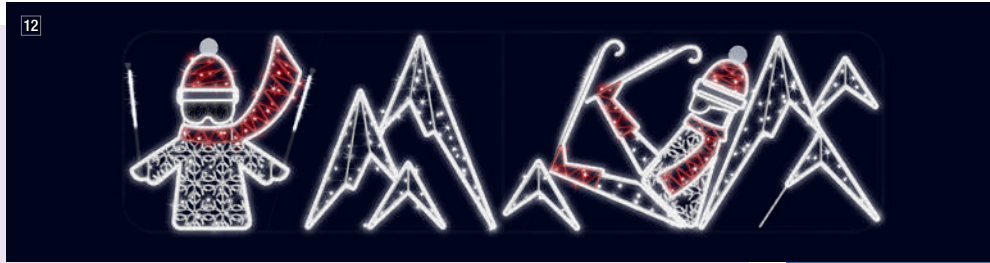

12 205122 ALPI
2D Across street.
H:1.05 W:4 m.
❄️ Ⓞ

13 205117 ALPI
2D Lamp column.
H:1 W:1 m.
❄️ Ⓞ

14 205131 ALPI 2
2D Lamp column.
H:2.5 W:1 m.
❄️ Ⓞ

15 205130 ALPI 2
2D Lamp column.
H:2 W:1 m.
❄️ Ⓞ

16 205119 ALPI 1
2D Lamp column.
H:2 W:1 m.
❄️ Ⓞ

17 205132 ALPI 2
2D Lamp column.
H:3 W:1 m.
❄️ Ⓞ

18 205120 ALPI 1
2D Lamp column.
H:2.5 W:1 m.
❄️ Ⓞ

19 205129 ALPI 2
2D Suspension.
H:1 W:1 m.
❄️ Ⓞ

20 202010 SNOW FLAKE
2D Suspension.
H:1 W:1 m.

21 202002 CRYSTAL FLAKE
2D Suspension.
H:1 W:1 m.

22 201211 FLOCON
STRASS LED
2D Suspension.
H:0.45 W:0.45 m.



NIGHT

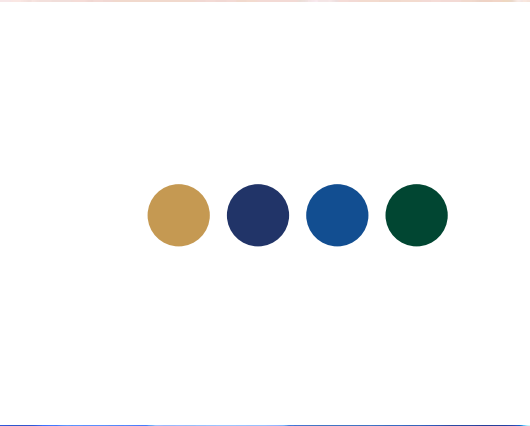
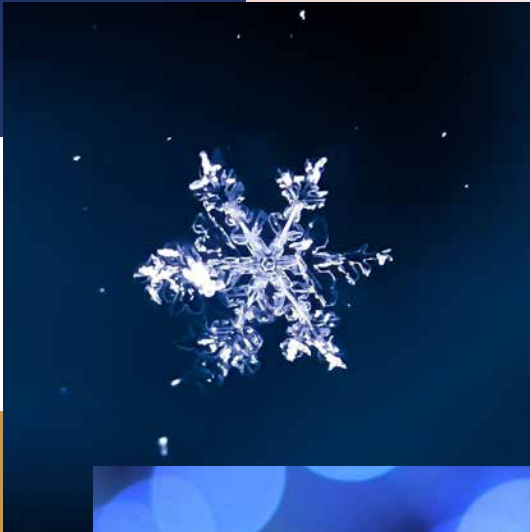

IMMERSE YOURSELF IN THE
SPLENDOUR OF A DAZZLING &
SUMPTUOUS XMAS.





ELEGANCE



*My Sumptuous
Christmas*

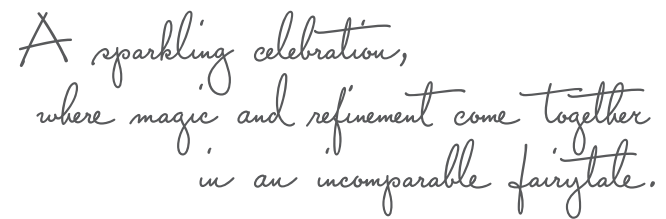

*A sparkling celebration,
where magic and refinement come together
in an incomparable fairytale.*



LIGHT

*My Sumptuous
Christmas*



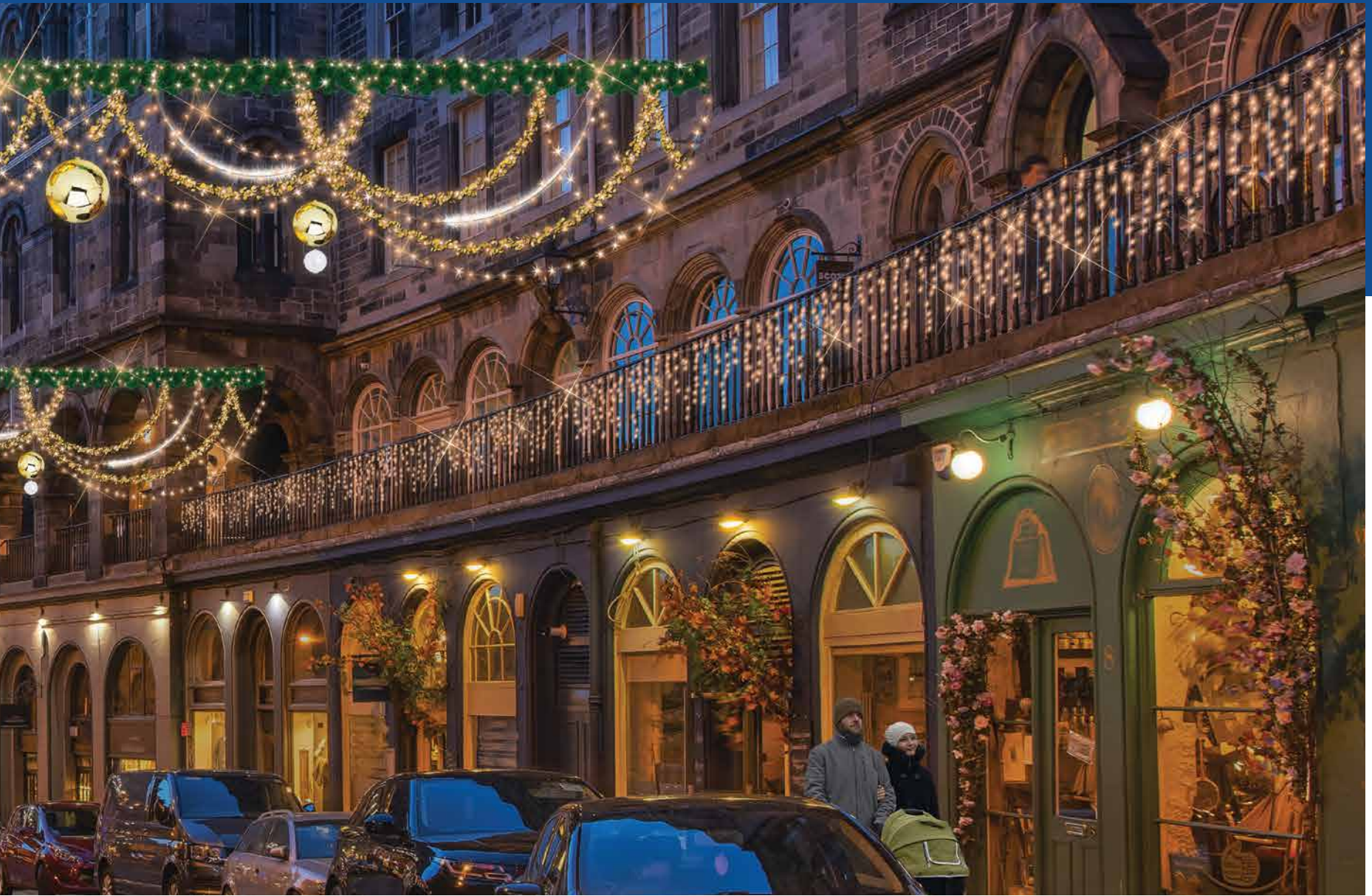

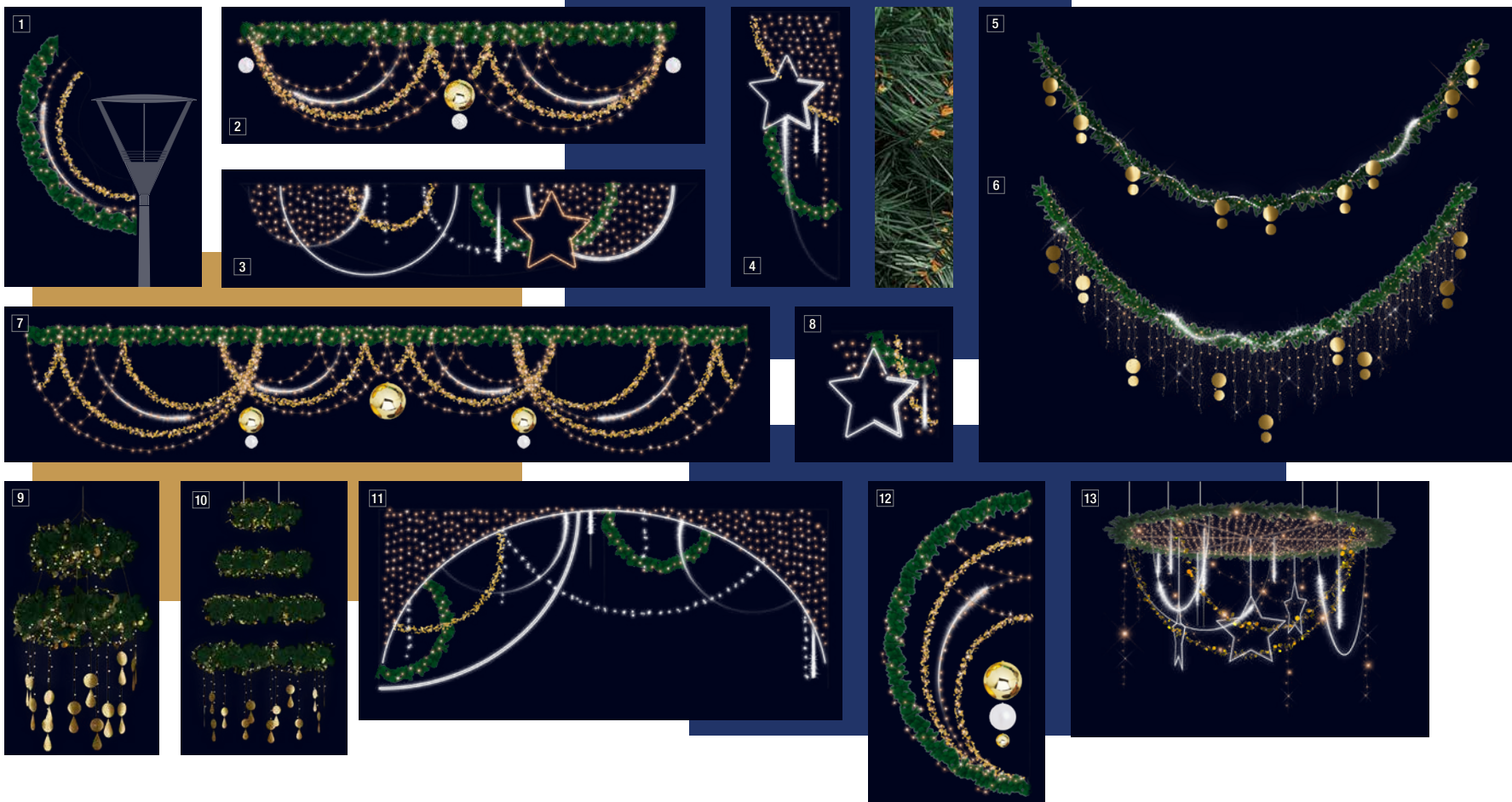

- 1 **205605*** ABBY
2D Globe.
H:2 W:1.25 m.
❄️ Ⓞ
- 2 **205606*** ABBY
2D Across street.
H:1 W:4 m.
❄️ Ⓞ
- 3 203040 COLLIER 2
2D Across street.
H:1 W:5 m.
❄️ Ⓞ
- 4 203039 COLLIER
2D Lamp column.
H:3 W:1 m.
❄️ Ⓞ
- 5 204582 SOUPLE
LOUISE 1
2D Across street.
H:0.5 W:5.2 m.
❄️ Ⓞ
- 6 204581 SOUPLE
LOUISE 2
3D Across street.
H:0.8 W:5.2 m.
❄️ Ⓞ
- 7 **205608*** ABBY
2D Across street.
H:1.3 W:8 m.
❄️ Ⓞ
- 8 203035 COLLIER
2D Lamp column.
H:1 W:1 m.
❄️ Ⓞ
- 9 205100 ARMONY
3D Suspension.
H:1.5 W:1 D:1 m.
❄️
- 10 205101 ARMONY
3D Suspension.
H:2.4 W:1.5 D:1.5 m.
❄️
- 11 203034 ARCHE
COLLIER
2D Across street.
H:2 W:5 m.
❄️ Ⓞ
- 12 **205604*** ABBY
2D Lamp column.
H:3 W:1.5 m.
❄️ Ⓞ
- 13 203042 LUSTRE
COLLIER
3D Suspension.
H:1.8 W:3 D:3 m.
❄️ Ⓞ

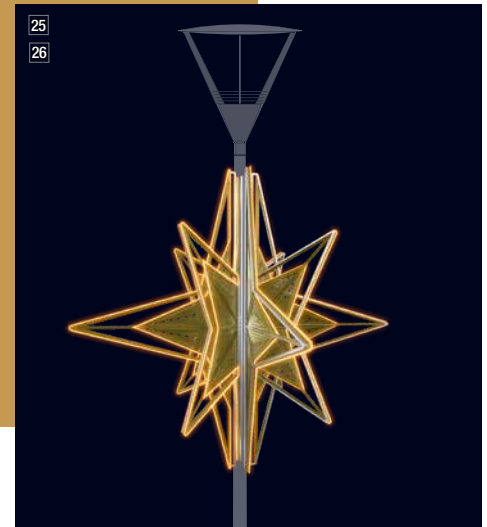
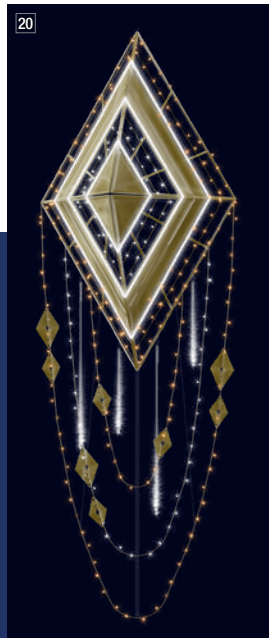
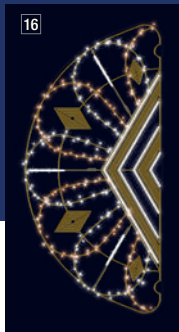

14 205547* MANDALA
2D Across street.
H:1 W:2.86 m.
☀️ Ⓞ

15 205548* MANDALA
2D Across street.
H:1 W:3.53 m.
☀️ Ⓞ

16 205541* MANDALA
2D Column & Across str.
H:2.5 W:1.15 m.
☀️ Ⓞ

17 205543* MANDALA
2D Lamp column.
H:3 W:1 m.
☀️ Ⓞ

18 205538* MANDALA
2D Column & Across str.
H:1 W:0.5 m.
☀️

19 205311 MAGIE
2D Suspension.
H:1 W:0.1 m.
Ⓞ

20 205544* MANDALA
3D Lamp column.
H:3.5 W:1.2 D:0.6 m.
☀️ Ⓞ

21 205546* MANDALA
2D Across street.
H:1 W:5 m.
☀️ Ⓞ

22 205309 MAGIE
2D Across street.
H:1 W:5 m.
☀️ Ⓞ Ⓞ Ⓞ Ⓞ

23 205310 MAGIE
2D Suspension.
H:0.9 W:1 m.
☀️ Ⓞ Ⓞ Ⓞ

24 205545* MANDALA
2D Suspension.
H:1.05 W:0.75 m.
☀️

25 205639* ASTRA M
3D Lamp column.
H:3 W:1.41 m.
Ⓞ Ⓞ

26 205640* ASTRA S
3D Lamp column.
H:1.53 W:0.76 m.
Ⓞ Ⓞ

* NEW

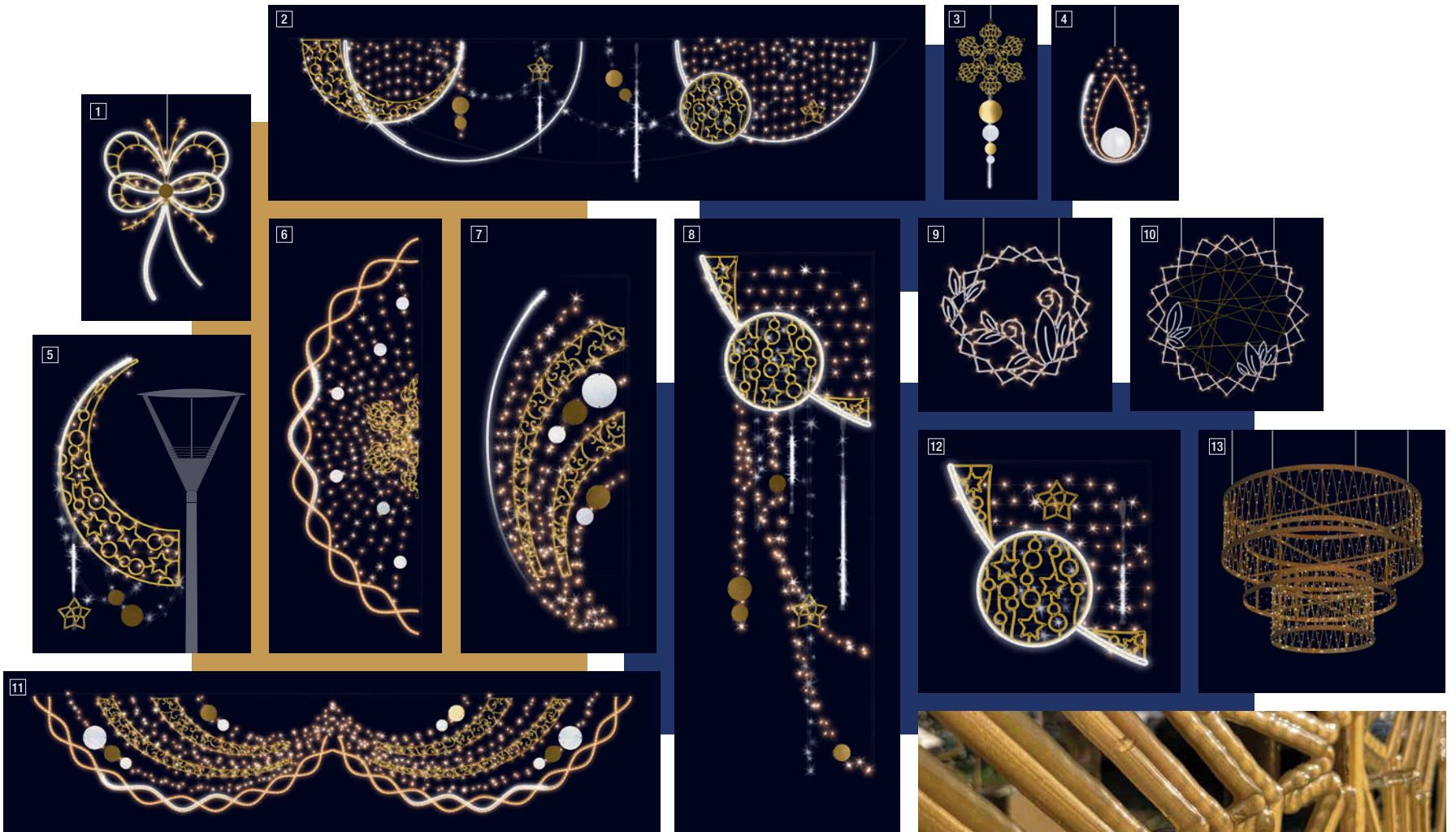

- | | | | | | | |
|--|---|---|--|---|---|--|
| <p>1 204599 NCEUD
2D Suspension.
H:1.3 W:0.9 m.
☼ ○ ○ ●</p> | <p>2 204388 COLLIER
2D Across street.
H:1.15 W:5 m.
☼ ⊗ ○ ○ ● ●</p> | <p>3 204263 SNOW
2D Suspension.
H:2 W:0.8 m.
⊗ ○ ○ ● ●</p> | <p>4 203369 GOUTTE
ALYA
2D Suspension.
H:1.1 W:0.6 m.
☼ ⊗ ○ ○ ● ●</p> | <p>5 204387 COLLIER
2D Globe.
H:1.7 W:0.75 m.
☼ ⊗ ○ ○ ● ●</p> | <p>6 204262 SNOW
2D Column & Across str.
H:3 W:1 m.
☼ ⊗ ○
● ● ● ● ● ● ● ●</p> | <p>7 204308 INAYA
2D Column & Across str.
H:2 W:0.8 m.
☼ ⊗ ○
● ● ● ● ● ● ● ●</p> |
| <p>8 204386 COLLIER
2D Lamp column.
H:3 W:1 m.
☼ ⊗ ○ ○ ● ●</p> | <p>9 204889-24V
COURONNE S
2D Suspension.
H:0.9 W:0.95 m.
☼</p> | <p>10 204890-24V
COURONNE S
2D Suspension.
H:1.5 W:1.5 m.
☼</p> | <p>11 204264 SNOW
2D Across street.
H:1 W:5 m.
☼ ⊗ ○
● ● ● ● ● ● ● ●</p> | <p>12 204382 COLLIER
2D Lamp column.
H:1 W:1 m.
☼ ⊗ ○ ○ ● ●</p> | <p>13 204712 CARILLON
3D Suspension.
H:1.4 W:2 D:2 m.
☼ ⊗ ○
● ● ● ● ● ● ● ●</p> | |



14 204892-24V PRÉCIEUSE
COURONNE L
2D Suspension.
H:1.5 W:1.5 m.
☀️ Ⓞ

20 204187 NOVA
2D Globe.
H:2.2 W:0.8 m.
☀️ Ⓞ ○ ● ●

15 204891-24V PRÉCIEUSE
COURONNE S
2D Suspension.
H:0.9 W:0.9 m.
☀️

21 204188 NOVA
2D Across street.
H:1 W:5 m.
☀️ Ⓞ ○ ● ●

16 204183 NOVA
2D Column & Across str.
H:2 W:1 m.
☀️ Ⓞ ○ ● ●

22 203405 ARCHE FILANTE
2D Across street.
H:2.5 W:6 m.
☀️ Ⓞ ○ ● ●

17 204186 NOVA
2D Suspension.
H:0.75 W:0.77 m.
☀️ ○ ● ●

23 202475 JOYEUSES
FÊTES EN FOLIE
2D Across street.
H:1 W:5 m.
☀️ ○ ● ●

18 204185 NOVA
2D Column & Across str.
H:3 W:1 m.
☀️ Ⓞ ○ ● ●

24 203419 JOYEUSES
FÊTES
2D Across street.
H:1.3 W:4.35 m.
☀️ ○ ● ● ●

19 205098 ARMONY
3D Lamp column.
H:3 W:2 D:2 m.
☀️ Ⓞ

*My Sumptuous
Christmas*





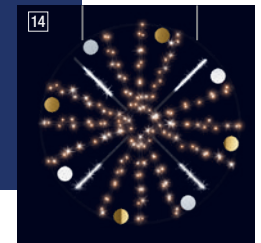
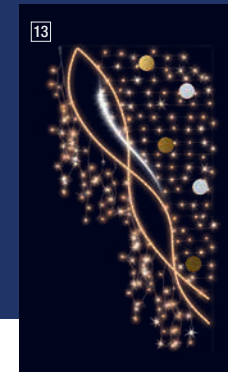
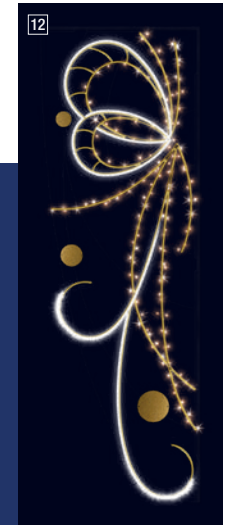
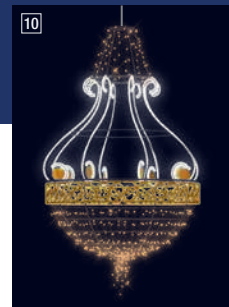
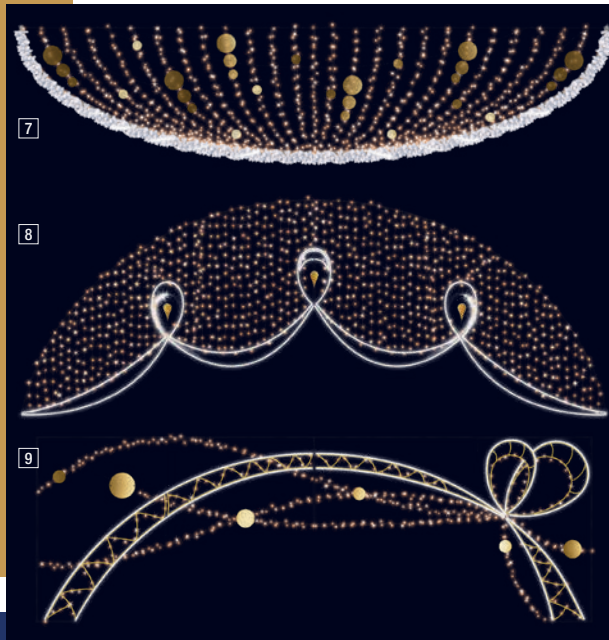
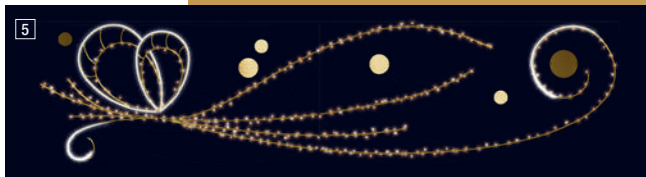
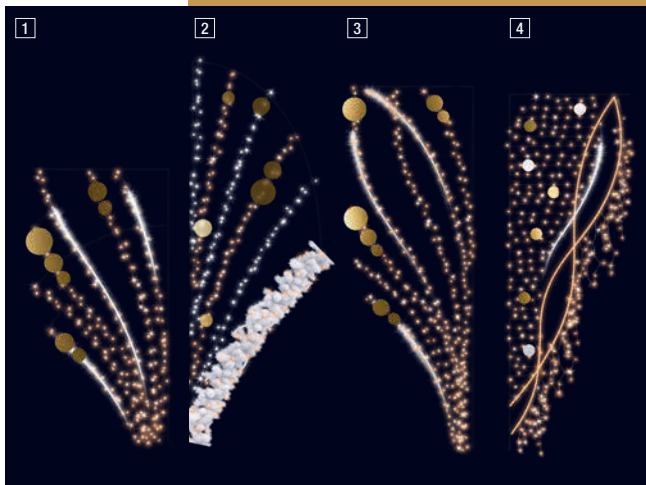

1 203751 LOUISE
2D Column & Across str.
H:2 W:1 m.
* (G) (O) (Y) (E) (S)

2 205103 ARMONY
2D Lamp column.
H:3 W:1.1 m.
* (G)

3 203750 LOUISE
2D Column & Across str.
H:3 W:1 m.
* (G) (O) (Y) (E) (S)

4 203368 ALYA
2D Column & Across str.
H:3 W:1 m.
* (G) (O) (Y) (E) (S)

5 204601 NCEUD 2
2D Across street.
H:1.4 W:6 m.
* (G) (O) (Y) (E) (S)

6 205102 ARMONY
2D Across street.
H:2.2 W:6 m.
* (G)

7 205097 ARMONY
2D Across street.
H:1.3 W:6 m.
* (G)

8 203403 ARCHE
RUBAN
2D Across street.
H:2.2 W:6 m.
* (G)

9 204603 ARCHE
NCEUD 2
2D Across street.
H:2 W:6 m.
* (O) (Y) (E) (S)

10 204725
CHANDELIER 2
3D Suspension.
H:2.2 W:1.3 D:1.3 m.
* (O) (Y) (E) (S)

11 205099 ARMONY
2D Lamp column.
H:3 W:1.5 m.
* (G)

12 204598 NCEUD 2
2D Lamp column.
H:3 W:1 m.
* (G) (O) (Y) (E) (S)

13 203366 ALYA
2D Column & Across str.
H:2 W:1 m.
* (G) (O) (Y) (E) (S)

14 203347 MILLÉSIME
2D Suspension.
H:1.35 W:1.35 m.
* (G) (O) (Y) (E) (S) (R) (B) (L) (A) (N) (C)

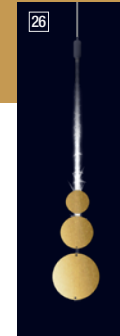
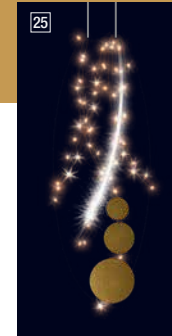
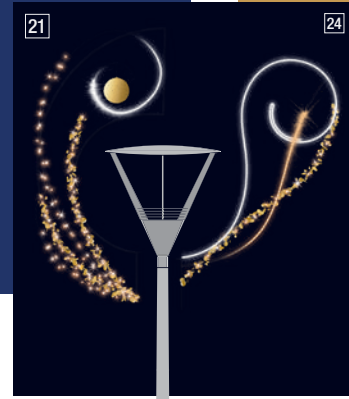
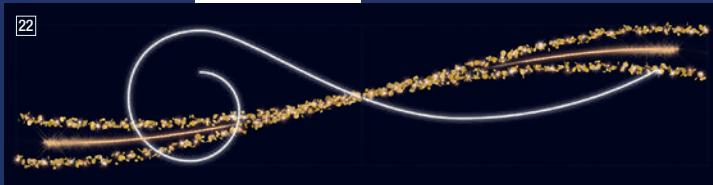
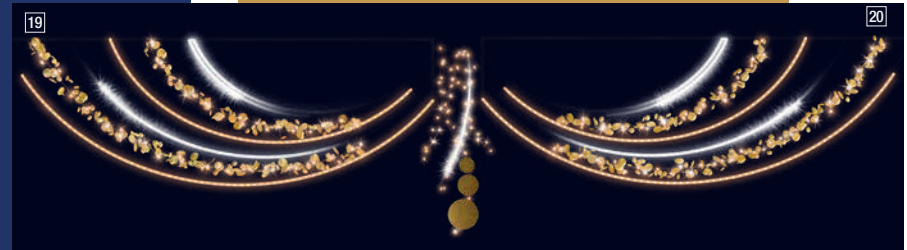
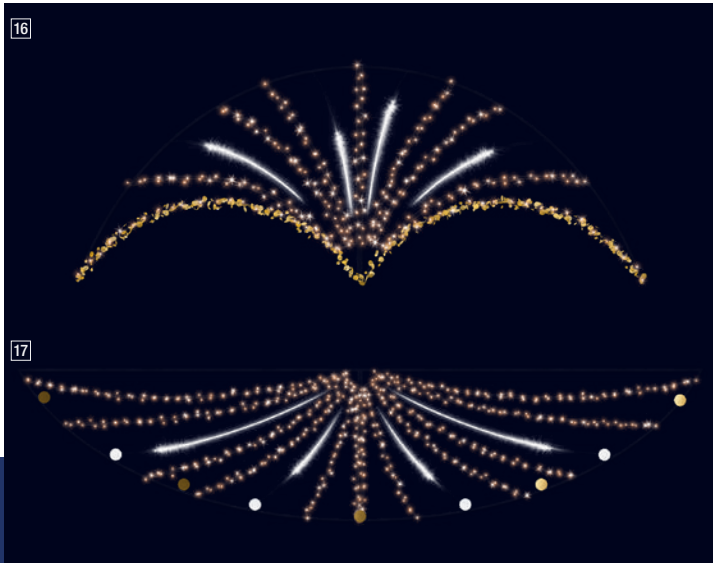
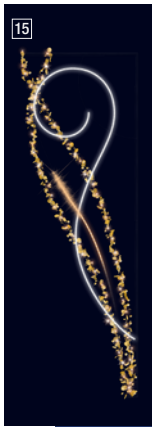

15 171108 MILA
2D Column & Across
str.
H:3 W:1 m.
☀️ Ⓞ ○ ● ●

16 203348 ARCHE
MILLÉSIME
2D Across street.
H:1.55 W:4 m.
☀️ Ⓞ ○ ● ● ● ● ● ● ● ●

17 203351 MILLÉSIME
2D Across street.
H:1.3 W:6 m.
☀️ Ⓞ ○ ● ● ● ● ● ● ● ●

18 203418 JOYEUSES
FÊTES RUBAN
2D Across street.
H:2 W:6 m.
☀️ Ⓞ

19 203371 ALYA
GAUCHE
2D Across street.
H:0.65 W:2 m.
☀️ Ⓞ ○ ● ●

20 203372 ALYA DROIT
2D Across street.
H:0.65 W:2 m.
☀️ Ⓞ ○ ● ●

21 203337 NCEUD
2D Globe.
H:2.2 W:1 m.
☀️ Ⓞ ○ ● ● ● ● ● ● ● ●

22 171109 MILA
2D Across street.
H:1 W:5 m.
☀️ Ⓞ ○ ● ●

23 203917 LOUISE
2D Across street.
H:1 W:5 m.
☀️ Ⓞ ○ ● ●

24 171232 MILA
2D Globe.
H:2 W:1.3 m.
☀️ Ⓞ ○ ● ●

25 203754 GRANDE
LOUISE
2D Suspension.
H:1.13 W:0.2 m.
☀️ Ⓞ ○ ● ●

26 203753 LOUISE
2D Suspension.
H:1.2 W:0.45 m.
Ⓞ ○ ● ●

27 203755 PETITE
LOUISE
2D Suspension.
H:0.63 W:0.14 m.
Ⓞ ○ ● ●

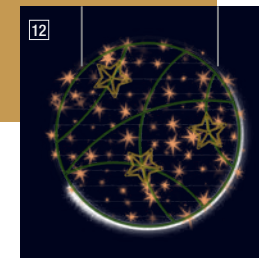
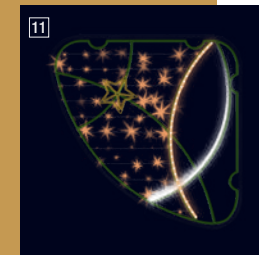
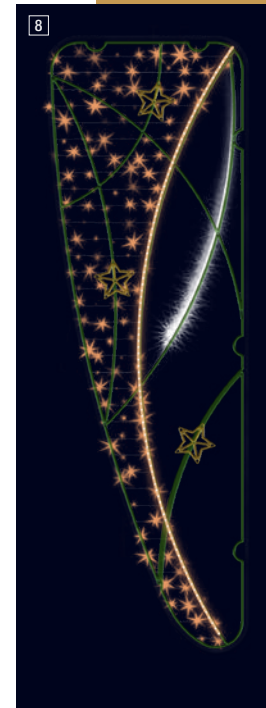
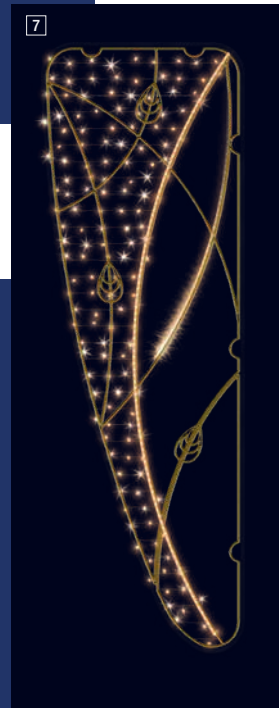
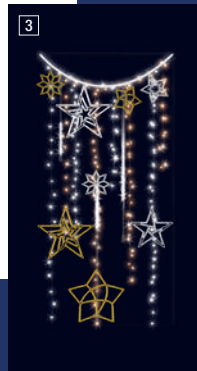

1 204336 MIRA ÉTOILE
2D Across street.
H:1.2 W:6 m.



2 204334 MIRA ÉTOILE
2D Lamp column.
H:3 W:1 m.



3 204332 MIRA ÉTOILE
2D Lamp column.
H:2 W:1 m.



4 205155 JOY GOUTTE
2D Column & Across str.
H:2 W:1 m.



5 204335 MIRA ÉTOILE
3D Globe.
H:1.2 W:1.25 D:1.25 m.



6 205565* LUSTRE JOY ÉTOILE
2D Suspension.
H:1.2 W:1.08 m.



7 205157 JOY GOUTTE
2D Column & Across str.
H:3 W:1 m.



8 205142 JOY ÉTOILE
2D Column & Across str.
H:3 W:1 m.



9 205293 JOY ÉTOILE
2D Suspension.
H:1 W:0.2 m.



10 205294 JOY ÉTOILE
2D Suspension.
H:0.5 W:0.1 m.



11 205138 JOY ÉTOILE
2D Column & Across str.
H:1 W:1 m.



12 205292 JOY ÉTOILE
2D Suspension.
H:1 W:1 m.



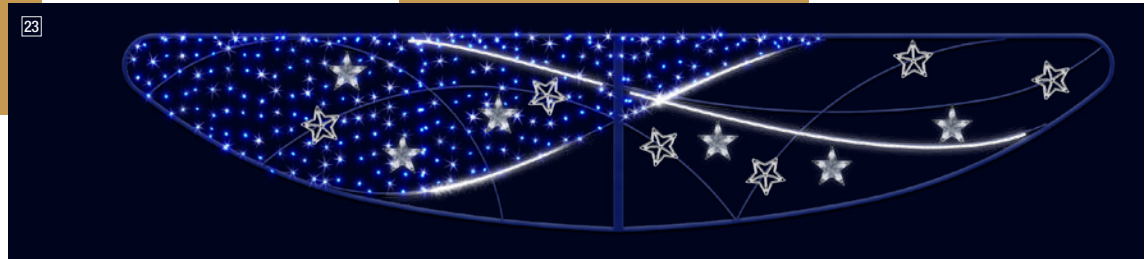
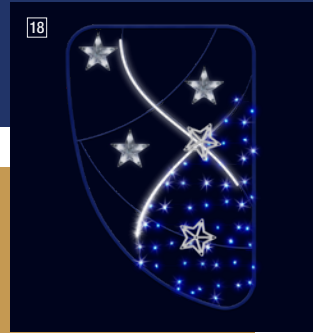
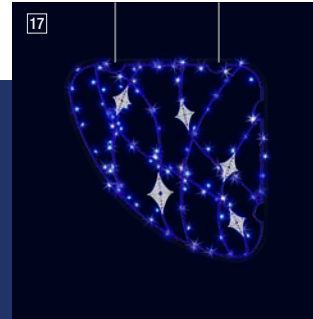
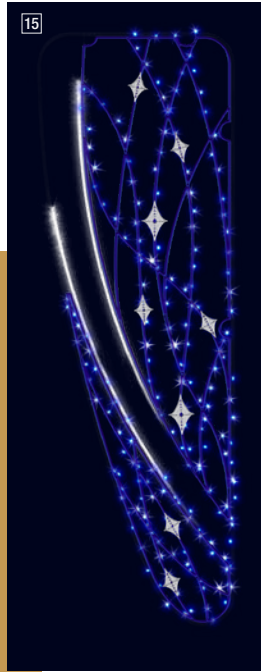
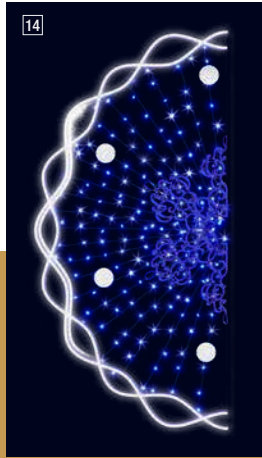
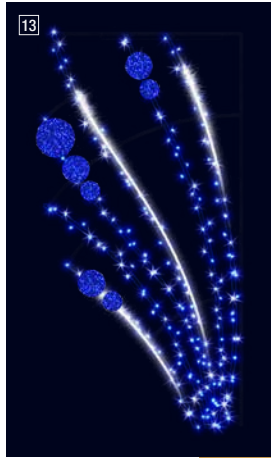

13 203765 LOUISE
2D Column & Across str.
H:2 W:1 m.
☀️ Ⓞ ○ ● ●

14 204274 SNOW
2D Column & Across str.
H:2 W:1 m.
☀️ Ⓞ ○ ● ● 🎵

15 205335 MAGIE
2D Column & Across str.
H:3 W:1 m.
☀️ Ⓞ ○ ● ●

16 205204 NAÉ STELLIZ
2D Column & Across str.
H:3 W:1 m.
☀️ Ⓞ ○ ● ●

17 205331 MAGIE
2D Column & Across str.
H:2 W:1 m.
☀️ ○ ○ ● ●

18 205201 NAÉ STELLIZ
2D Column & Across str.
H:1.5 W:1 m.
☀️ Ⓞ ○ ● ●

19 205333 MAGIE
2D Column & Across str.
H:2 W:1 m.
☀️ Ⓞ ○ ● ●

20 203769 PETITE LOUISE
2D Suspension.
H:0.63 W:0.14 m.
Ⓞ ○ ○ ● ●

21 203768 GRANDE LOUISE
2D Suspension.
H:1.13 W:0.2 m.
Ⓞ ○ ○ ● ●

22 203767 LOUISE
2D Suspension.
H:1.2 W:0.45 m.
☀️ Ⓞ ○ ● ●

23 205205 NAÉ STELLIZ
2D Across street.
H:1 W:5 m.
☀️ Ⓞ ○ ● ●



HEAT

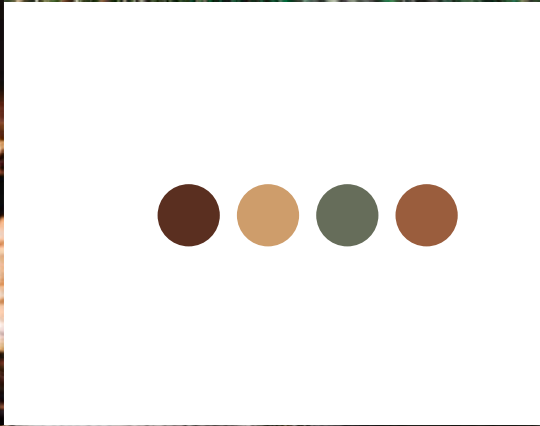

EXPERIENCE AN AUTHENTIC XMAS,
WHERE THE WARMTH
OF HEARTS MINGLES WITH
THE SOUND OF WOOD CRACKLING





WOOD

My Authentic Christmas

*Celebrate the beauty
of the season
that shines brightly*

CINNAMON

*My Authentic
Christmas*





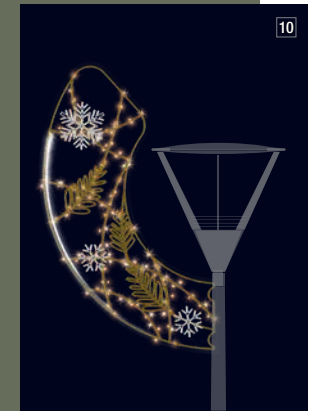
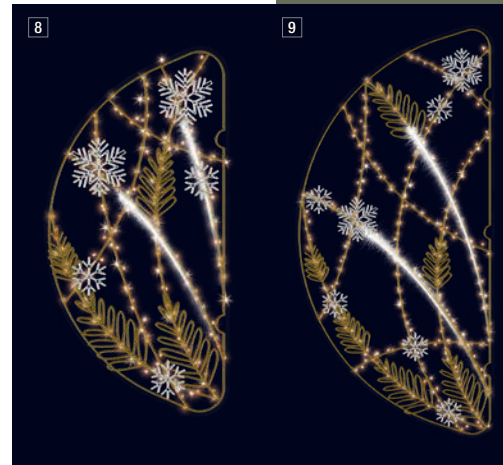
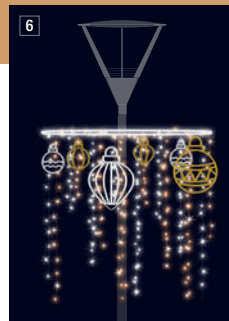

1 204353 MIRA BOULE
2D Lamp column.
H:2 W:1 m.
* * * * *

2 204355 MIRA BOULE
2D Lamp column.
H:3 W:1 m.
* * * * *

3 205231 GIVRE
2D Across street.
H:1 W:5 m.
* * * * *

4 204357 MIRA BOULE
2D Across street.
H:1.2 W:6 m.
* * * * *

5 202643 PETITE LANTERNE
3D Suspension.
H:0.6 W:0.3 D:0.3 m.
* * * * *

6 204356 MIRA BOULE
Globe 3D.
H:1.2 W:1.25 D:1.25 m.
* * * * *

7 205233 GIVRE
2D Suspension.
H:0.8 W:0.8 m.
* * * * *

8 205228 GIVRE
2D Column & Across str.
H:2 W:1 m.
* * * * *

9 205230 GIVRE
2D Column & Across str.
H:3 W:1.5 m.
* * * * *

10 205232 GIVRE
Globe 2D.
H:2 W:1.2 m.
* * * * *

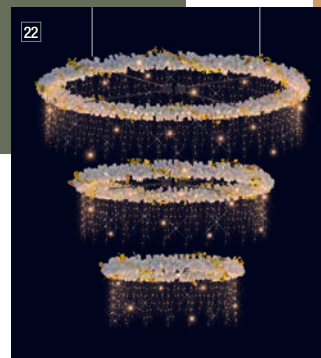
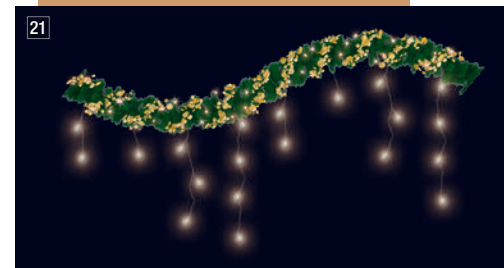
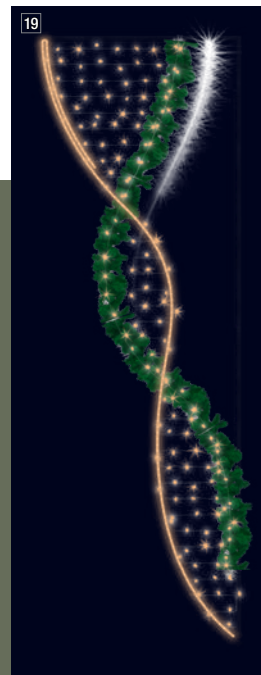
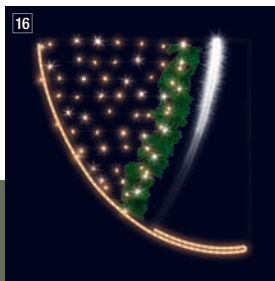
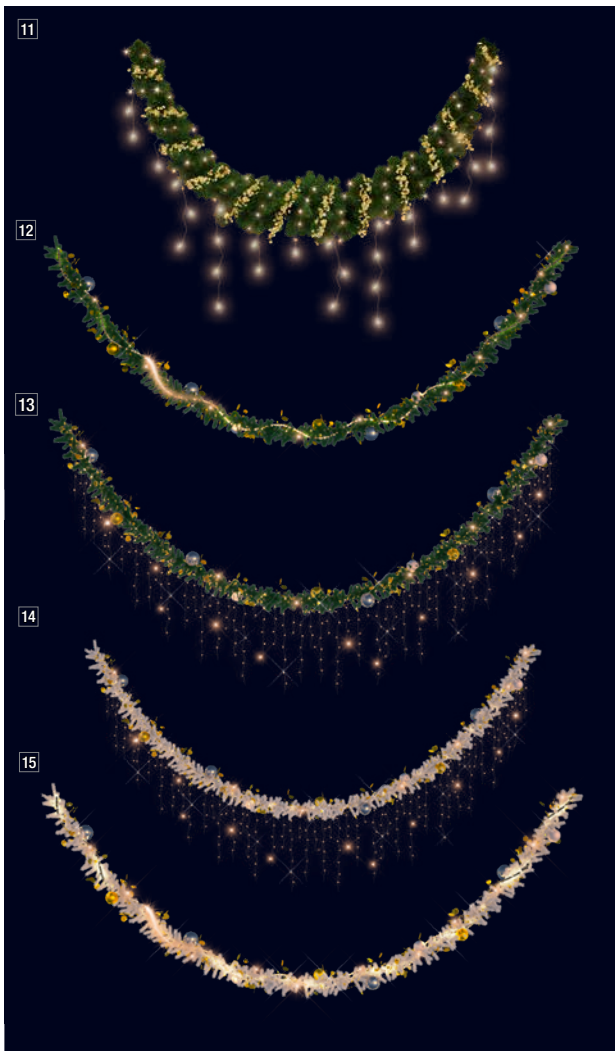

11 205598* SOUPLE FILAMENT
2D Across street.
H:2 W:4 m.
☼

12 203294 SOUPLE MERRY
2D Across street.
H:0.24 W:5.2 m.
☼ Ⓞ

13 203295 SOUPLE MERRY
2D Across street.
H:0.8 W:5.2 m.
☼

14 203297 SOUPLE ENCHANTÉE
2D Across street.
H:0.8 W:5.2 m.
☼

15 203296 SOUPLE ENCHANTÉE
2D Across street.
H:0.24 W:5.2 m.
☼ Ⓞ

16 202932 ELFIE
2D Column & Across str.
H:1 W:1 m.
☼ Ⓞ ○ ○ ●

17 203298 ZÉBULON
2D Suspension.
H:1 W:1 m.
Ⓞ

18 205599* COURONNE FILAMENT
2D Suspension.
H:1.5 W:0.85 m.
☼

19 202936 ELFIE
2D Column & Across str.
H:3 W:1 m.
☼ Ⓞ ○ ○ ●

20 203669 NOËL OR
2D Suspension.
H:2 W:2.7 m.
☼ Ⓞ

21 205597* FILAMENT
2D Across street.
H:1.2 W:2.5 m.
☼

22 203253 ONDE ENCHANTÉE
3D Suspension.
H:3.3 W:3.5 D:3.5 m.
☼ ○ ○ ●

* NEW

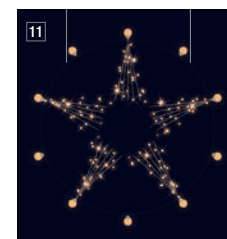
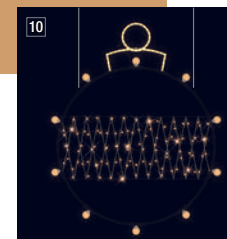
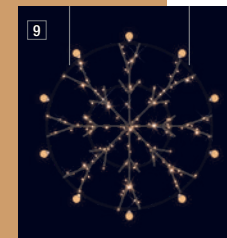
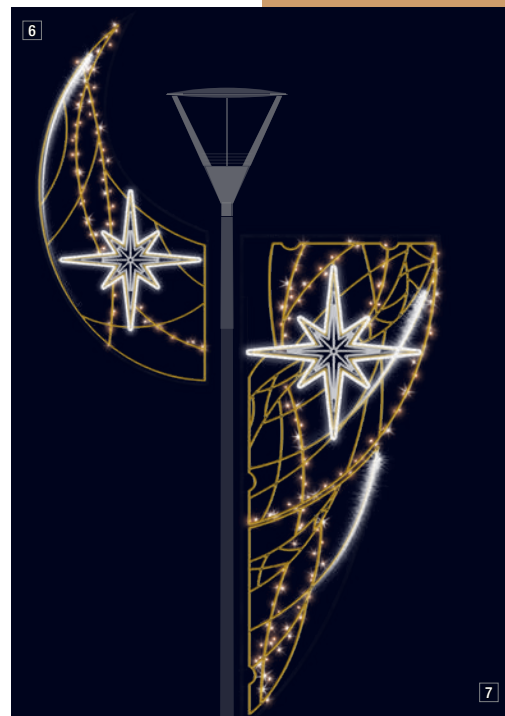
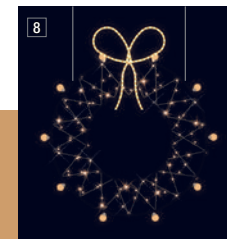
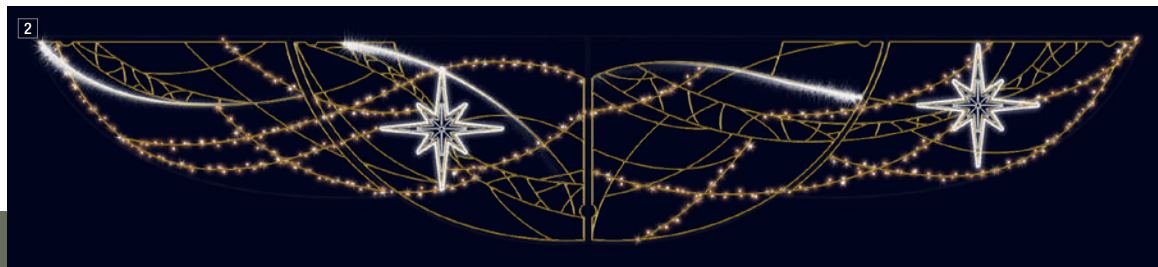

1 205552* STARLIGHT
3D Lamp column.
H:2.5 W:1 D:0.5 m.
☼ Ⓞ

2 204417 ATMOS
2D Across street.
H:1.5 W:8 m.
☼ Ⓞ ● ●

3 205549* STARLIGHT
3D Lamp column.
H:1 W:1 D:0.5 m.
☼ Ⓞ

4 204717 LUSTRE
DENTELLE
3D Suspension.
H:2.2 W:1.8 D:1.55 m.
☼ ● ● ●

5 204415 ATMOS
2D Suspension.
H:0.85 W:0.85 m.

6 204416 ATMOS
Globe 2D.
H:2.3 W:1.1 m.
☼ Ⓞ ● ●

7 204413 ATMOS
2D Column & Across str.
H:2.5 W:1 m.
☼ Ⓞ ● ●

8 201978 COURONNE
VINTAGE
2D Suspension.
H:1.2 W:1 m.
☼

9 201975 FLOCON
VINTAGE
2D Suspension.
H:1 W:1 m.
☼

10 201976 BOULE VINTAGE
2D Suspension.
H:1.28 W:1 m.
☼

11 201977 ÉTOILE VINTAGE
2D Suspension.
H:1 W:1 m.
☼



12 203780 AGATHE
2D Column & Across str.
H:2 W:1 m.
* ⦿ ○ ○ ● ●

13 203778 AGATHE
2D Column & Across str.
H:3 W:1 m.
* ⦿ ⦿ ○ ● ●

14 203783 AGATHE
BONNES FÊTES
2D Across street.
H:1.15 W:5 m.
* ⦿ ⦿ ○ ● ●

15 550627 JOYEUSES
FÊTES
2D Across street.
H:1.50 W:3 m.
CROMEX

16 201844 BULLE D'OR
3D Suspension.
H:1.2 W:0.55 D:0.55 m.
* ⦿

17 205525* ÉTOILE GIVRÉE
2D Column & Across str.
H:3 W:1 m.
* ⦿ ⦿ ○

18 203925 AGATHE
2D Across street.
H:1 W:5 m.
* ⦿ ⦿ ○ ● ●

19 205526* ÉTOILE GIVRÉE
2D Suspension.
H:0.93 W:0.93 m.
* ⦿ ○

20 201848 JARDIN
FÉÉRIQUE
3D Suspension.
H:1.5 W:0.45 D:0.45 m.
* ⦿

21 205522* ÉTOILE GIVRÉE
2D Column & Across str.
H:1.5 W:1 m.
* ⦿ ⦿ ○

22 203234 JOYEUSES
FÊTES SONGE
2D Across street.
H:0.83 W:3 m.
* ⦿

* NEW

*My Authentic
Christmas*



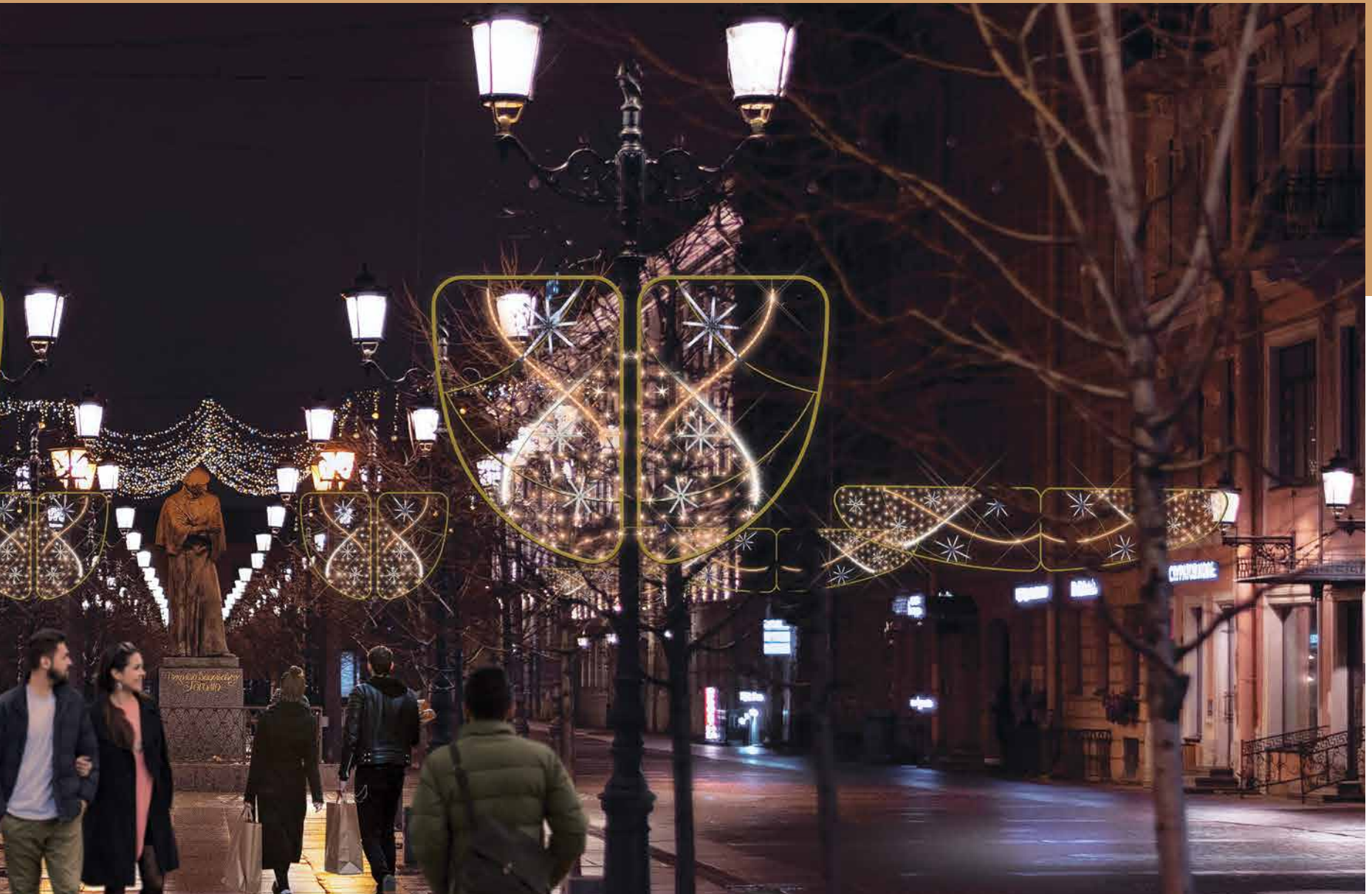

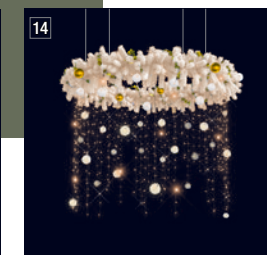
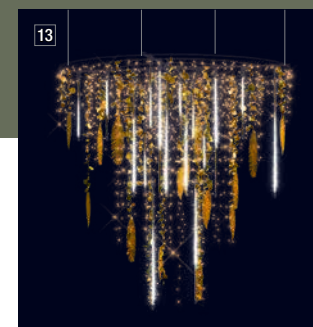
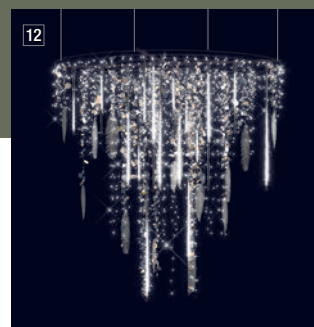
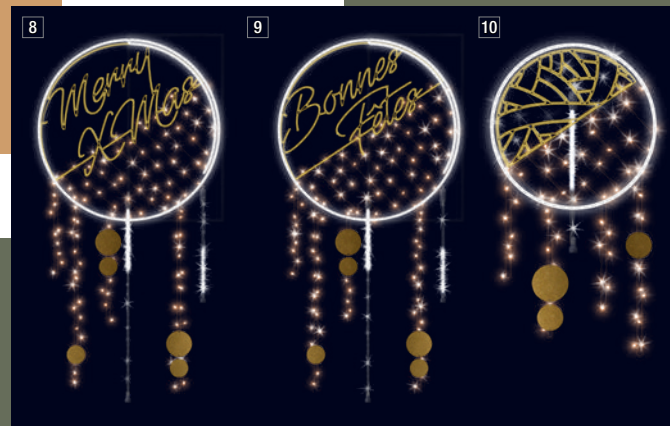
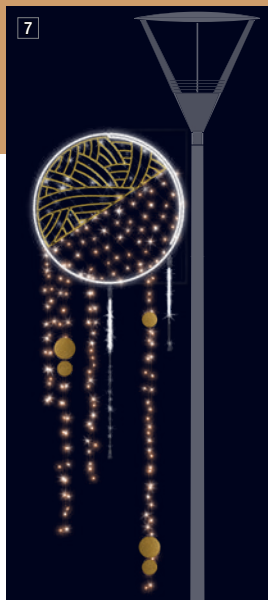
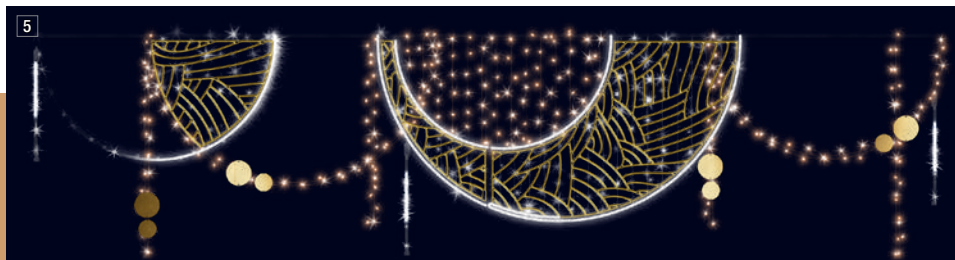
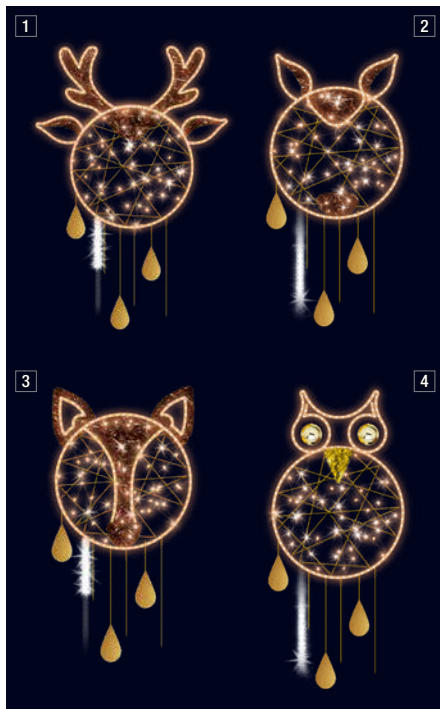

1 203236 DREAM CERF
2D Suspension.
H:1.46 W:0.97 m.
☼ Ⓞ

2 203237 DREAM RENNE
2D Suspension.
H:1.32 W:0.6 m.
☼ Ⓞ

3 203238 DREAM RENARD
2D Suspension.
H:1.28 W:0.64 m.
☼ Ⓞ

4 203235 DREAM HIBOU
2D Suspension.
H:1.43 W:0.6 m.
☼ Ⓞ

5 204133 DREAM 2D Across street.
H:1.2 W:5 m.
☼ Ⓞ ● ● ● ● ●

6 203249 PETITE COURONNE DREAM
3D Suspension.
H:1.2 W:1.2 D:0.2 m.
☼

7 204130 DREAM 2D Lamp column.
H:3 W:1 m.
☼ Ⓞ ● ● ● ● ●

8 204137 DREAM XMAS
2D Lamp column.
H:2 W:1 m.
☼ Ⓞ ● ● ● ● ●

9 204139 DREAM BONNES FÊTES
2D Lamp column.
H:2 W:1 m.
☼ Ⓞ ● ● ● ● ●

10 204131 DREAM 2D Suspension.
H:1.2 W:0.6 m.
☼ Ⓞ ● ● ● ● ●

11 204132 DREAM Globe 2D.
H:2 W:1 m.
☼ Ⓞ ● ● ● ● ●

12 203413 LUSTRE PLUMES
3D Suspension.
H:2 W:2 D:2 m.
☼ Ⓞ ● ● ● ● ●

13 203657 LUSTRE PLUMES
3D Suspension.
H:2 W:2 D:2 m.
☼ Ⓞ ● ● ● ● ●

14 203233 COURONNE SONGE
3D Suspension.
H:1.8 W:2 D:2 m.
☼

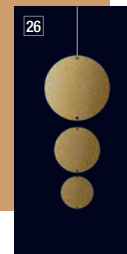
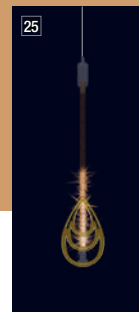
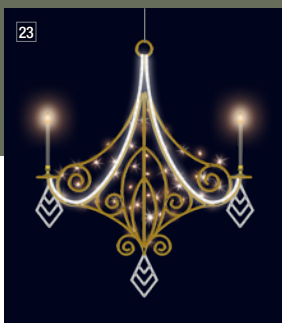
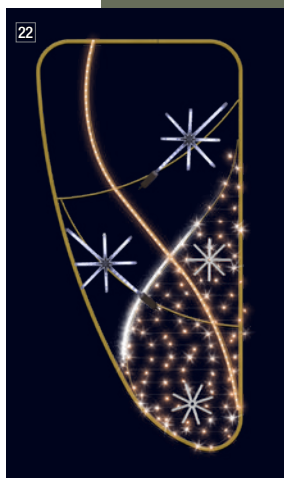
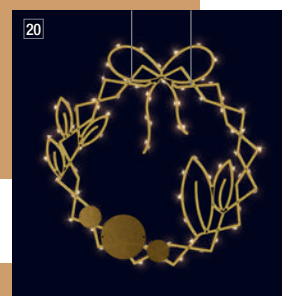
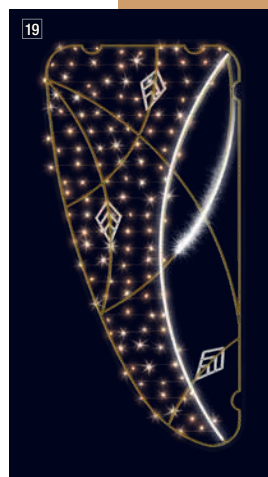
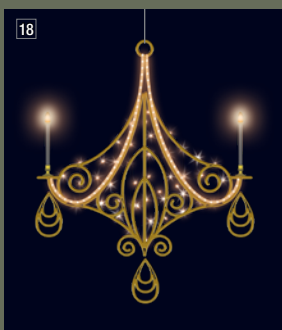
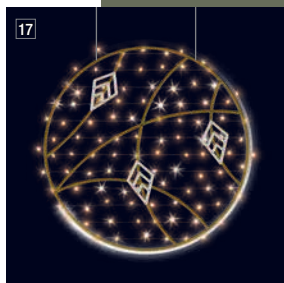
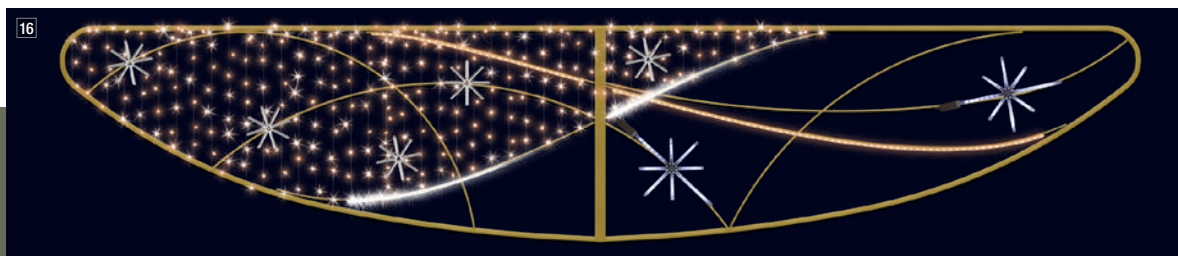

15 205301 JOY GOUETTE
2D Suspension.
H:1 W:1 m.
☼ ☉

16 205163 NAÉ FLOKO
2D Across street.
H:1 W:5 m.
☼ ☉ ○ ● ●

17 205295 JOY DIAMANT
2D Suspension.
H:1 W:1 m.
☼ ☉

18 205568* LUSTRE JOY GOUTTE
2D Suspension.
H:1.2 W:1.08 m.
☼

19 205145 JOY DIAMANT
2D Column & Across str.
H:2 W:1 m.
☼ ☉

20 204883 COURONNE ENCHANTÉE S
2D Suspension.
H:1 W:0.95 m.
☼

21 204884 COURONNE ENCHANTÉE L
2D Suspension.
H:1.5 W:1.5 m.
☼

22 205160 NAÉ FLOKO
2D Column & Across str.
H:2 W:1 m.
☼ ☉ ○ ● ●

23 205564* LUSTRE JOY DIAMANT
2D Suspension.
H:1.2 W:1.08 m.
☼

24 205297 JOY DIAMANT
2D Suspension.
H:0.5 W:0.1 m.
☉

25 205303 JOY GOUTTE
2D Suspension.
H:0.5 W:0.1 m.
☉

26 203782 AGATHE
2D Suspension.
H:0.5 W:0.2 m.
○ ○ ● ●

27 202986 ZEF
3D Suspension.
H:0.6 W:0.24 D:0.24 m.
☉ ○ ○

* NEW

Decorations to install







Villeneuve-d'Ornon • France



Pairi Daiza • Belgium



Auxerre • France



Lustica Bay Luxury Resort • Montenegro



Reims • France



Bussy-Saint-Georges • France

Reims • France



Pia • France



Verdun • France



Verdun • France

Carnac • France



Pia • France



Dunkerque • France

3D arches



**Discover our 3D arches creations
by scanning this QR-Code.**







1 205045 ARCHE CASSE-NOISETTE

3D floorstanding decoration.
H:4 W:6.5 D:1.1 m.



2 203143 ARCHE ÉTOILE

3D floorstanding decoration.
H:5.5 W:7.7 D:1 m.



3 203141 ARCHE SAPIN

3D floorstanding decoration.
H:4.85 W:5.2 D:1 m.



4 205619* ARCHE SAPINETTE

2D floorstanding decoration.
H:2.8 W:3.8 m.



5 205618* ARCHE SAPINETTE

2D floorstanding decoration.
H:2.8 W:3.8 m.



6 203142 ARCHE CADEAU

3D floorstanding decoration.
H:4.7 W:5.25 D:1 m.



7 205617* ARCHE

SAPIN COURBÉ
3D floorstanding decoration.
H:3.9 W:6.4 D:2.5 m.





8 205591* ARCHE XMAS
3D floorstanding decoration.
H:3.8 W:4.9 D:0.8 m.
❄️



9 204698 ARCHÉTOILE
3D floorstanding decoration.
H:4 W:5.25 D:1 m.
❄️ Ⓞ ○ ● ●



12

12 205590* ARCHE NOËL
3D floorstanding decoration.
H:3.85 W:4.9 D:0.8 m.
❄️

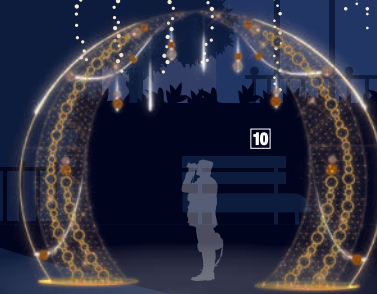

10

10 204686 ARCHE CHAMPAGNE
3D floorstanding decoration.
H:4 W:5.5 D:1.5 m.
❄️ Ⓞ ○ ● ●



11

11 204694 ARCHE NOVA
3D floorstanding decoration.
H:4 W:4.5 D:1.5 m.
❄️ Ⓞ ○ ● ●

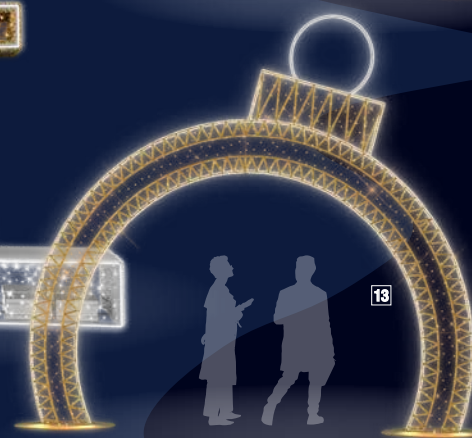

13

13 204690 ARCHE BOULE
3D floorstanding decoration.
H:4 W:4.5 D:1 m.
❄️ ○ ○ ● ●

*** NEW**

Please note: optional accessories required for installation

Sparkling decors



Scan this QR-Code to discover our sparkling decors creations.







- | | | | | | |
|---|--|--|---|---|--|
| <p>1 203147 SAPIN
PÉTILLANT
3D floorstanding decor.
H:5 W:2.5 D:0.9 m.
* ○ ○</p> | <p>2 202987 SUCRES
D'ORGE PÉTILLANT
3D floorstanding decor.
H:1.95 W:2.2 D:0.3 m.
* ○ ○</p> | <p>3 202989 FLOCON
PÉTILLANT
3D floorstanding decor.
H:2 W:2.2 D:0.3 m.
* ○ ○</p> | <p>4 203144 ÉTOILE
PÉTILLANTE
3D floorstanding decor.
H:1.8 W:2.4 D:0.3 m.
* ○ ○</p> | <p>5 204735 GINGER
PÉTILLANT
3D floorstanding decor.
H:2 W:2.2 D:0.3 m.
* ○ ○</p> | <p>6 202988 RENNE
PÉTILLANT
3D floorstanding decor.
H:1.95 W:1.4 D:0.3 m.
* ○ ○</p> |
| <p>7 204737 BOUGIE
PÉTILLANTE
3D floorstanding decor.
H:2 W:1 D:0.3 m.
* ○ ○</p> | <p>8 202991 CŒUR
PÉTILLANT
3D floorstanding decor.
H:1.7 W:2.2 D:0.3 m.
* ○ ○</p> | <p>9 203145 BOULE
PÉTILLANTE
3D floorstanding decor.
H:2 W:2.3 D:0.3 m.
* ○ ○</p> | <p>10 204733 HOUX
PÉTILLANT
3D floorstanding decor.
H:2 W:2.6 D:0.3 m.
* ○ ○</p> | <p>11 203146 CADEAU
PÉTILLANT
3D floorstanding decor.
H:1.8 W:2 D:0.3 m.
* ○ ○</p> | |



12 204730 SNOWMAN PÉTILLANT
3D floorstanding decoration.
H:2 W:2 D:0.3 m.
❄️○○

13 205592* BOULE ÉTINCELANTE
3D floorstanding decoration.
H:2 W:1.68 D:0.3 m.
❄️

14 205595* ÉTOILE ÉTINCELANTE
3D floorstanding decoration.
H:2 W:1.58 D:0.3 m.
❄️

15 205594* SAPIN ÉTINCELANT
3D floorstanding decoration.
H:2 W:1.88 D:0.3 m.
❄️

16 204740 SAPIN PÉTILLANT
3D floorstanding decoration.
H:2 W:2 D:0.3 m.
❄️○○

17 205596* PÈRE NOËL ÉTINCELANT
3D floorstanding decoration.
H:2 W:1.57 D:0.3 m.
❄️

18 204732 ECLAT PÉTILLANT
3D floorstanding decoration.
H:2 W:2.9 D:0.3 m.
❄️○○

19 205593* CADEAU ÉTINCELANT
3D floorstanding decoration.
H:2 W:2 D:0.3 m.
❄️

*** NEW**

Please note: optional accessories required for installation

2D arches



**Discover our 2D arches creations
by scanning this QR-Code.**







1 204676 RENNE
2D floorstanding decoration.
H:2 W:1.6 m.
* ○ ○

2 204682 SAPIN L
2D floorstanding decoration.
H:2 W:1.2 m.
* ○ ○

3 204680 SAPIN M
2D floorstanding decoration.
H:1.5 W:0.95 m.
* ○ ○

4 204678 SAPIN S
2D floorstanding decoration.
H:1 W:0.65 m.
* ○ ○

5 203912 J'M MA VILLE M
2D floorstanding decoration.
H:2.5 W:4.3 m.
* ○ ● ●

6 204672 ÉTOILE NOVA
2D floorstanding decoration.
H:1.5 W:2.15 m.
* ○ ○ ● ●

7 204661 BOULE STAR
2D floorstanding decoration.
H:0.8 W:0.8 m.
* ○ ○ ● ●

8 204669 FLAKE
2D floorstanding decoration.
H:0.8 W:1.4 m.
* ⊕ ○ ○ ●

9 204665 BOULE ARTY
2D floorstanding decoration.
H:0.8 W:0.8 m.
* ○ ○ ● ●



10 205349 ARCEAU ALPI
2D floorstanding decoration.
H:2 W:3.5 m.
☼

11 203323 ARCEAU BOULE
2D floorstanding decoration.
H:1.75 W:3.5 m.
☼ ● ● ●

12 203309 ARCEAU CADEAU
2D floorstanding decoration.
H:2.5 W:3.5 m.
☼ ⊗ ○ ● ● ●

13 203352 ARCEAU MILLÉSIME 1
2D floorstanding decoration.
H:2.5 W:3.5 m.
☼ ⊗ ○ ○ ● ● ● ⊗ ⊗

14 204684 SNOWMAN
2D floorstanding decoration.
H:1.5 W:1.25 m.
☼

15 205350 ARCEAU ALPI
2D floorstanding decoration.
H:1 W:2 m.
☼

16 203324 ARCEAU BOULE
2D floorstanding decoration.
H:1.3 W:2 m.
☼ ○ ● ● ●

17 203322 ARCEAU BOULE
2D floorstanding decoration.
H:1.5 W:2.15 m.
☼ ● ● ●

Photoboaths & Frames



Scan this QR-Code to find out more
about our photoboaths and frames.







1 202679 PÔLE NORD
3D floorstanding decoration.
H:3 W:1.3 D:1.45 m.



2 203730 CADEAU PHOTO
3D floorstanding decoration.
H:2.25 W:2.55 D:1 m.



3 203308 CADEAU RUBAN
3D floorstanding decoration.
H:3 W:6.3 D:1 m.



4 205589* CADRE PÈRE NOËL
3D floorstanding decoration.
H:2.75 W:1.95 D:1.08 m.



5 204645 LUTIN PHOTO
3D floorstanding decoration.
H:1.7 W:1.3 D:0.7 m.



6 205587* CADRE PINGOUIN
3D floorstanding decoration.
H:2.55 W:1.95 D:1.08 m.





7

7 204702 KIOSQUE
3D floorstanding decoration.
H:3 W:2.4 D:2.4 m.
☼ Ⓞ ○ ● ● ● ● ●

8

8 204659 CADRE DE NOËL
2D floorstanding decoration.
H:2.6 W:4 m.
☼

9

10

9 204685 CADRE PHOTO
2D floorstanding decoration.
H:2.55 W:1.95 m.
☼

11

10 204711 JOYEUX NOËL
2D floorstanding decoration.
H:0.83 W:1.6 m.

11 205586* CADRE RENNE
3D floorstanding decoration.
H:2.8 W:1.95 D:1.08 m.
☼

12

12 205588* CADRE OURS
3D floorstanding decoration.
H:2.65 W:1.95 D:1.08 m.
☼

*** NEW**

Please note: optional accessories required for installation

Armchairs & Seats



Scan this QR-Code to discover
our armchairs & seats creations.







1 205624* ECLAIR
3D floorstanding decoration.
H:1.95 W:1.25 D:0.33 m.
❄️

2 205622* TORNADE
3D floorstanding decoration.
H:1.95 W:1.25 D:0.33 m.
❄️

3 205623* TONNERRE
3D floorstanding decoration.
H:1.95 W:1.25 D:0.33 m.
❄️

4 205621* TRAINEAU DE LAPONIE
3D floorstanding decoration.
H:1.65 W:1.1 D:3.1 m.
❄️ Ⓞ

5 205373 TRAINEAU E-DECO
3D floorstanding decoration.
H:1.2 W:2.6 D:1.1 m.
❄️ Ⓞ ○ ○ ●

6 205372 RENNES E-DECO
3D floorstanding decoration.
H:1.5 W:1.12 D:1 m.
❄️ ○ ○ ●

7 202798 BAUBLE CHAIR
3D floorstanding decoration.
H:1.7 W:1.2 D:1.2 m.
❄️ ○ ○ ● ● ●



8



9



10



11



12



13



14

8 204639 FAUTEUIL RENNE
3D floorstanding decoration.
H:2.2 W:2 D:2 m.



9 204638 FAUTEUIL OURS
3D floorstanding decoration.
H:1.8 W:2 D:2 m.



10 204640 FAUTEUIL NOËL
3D floorstanding decoration.
H:2 W:2 D:2 m.



11 205620* PETIT TRAINEAU
3D floorstanding decoration.
H:2 W:1.8 D:1.83 m.



12 202673 FAUTEUIL CADEAU
3D floorstanding decoration.
H:1 W:1.2 D:1 m.



13 203176 RENNE COMÈTE
3D floorstanding decoration.
H:2 W:1.49 D:0.63 m.



14 203131 TRAINEAU CRISTAL
3D floorstanding decoration.
H:1.87 W:4.14 D:1.45 m.



* NEW

Please note: optional accessories required for installation

Playful Decors



Scan this QR-Code to discover
our playful decor creations.







1 204650 LUGE DES LUTINS
3D floorstanding decoration.
H:1 W:2 D:0.95 m.
❄️ Ⓞ

4 204636 PETIT TRAIN
3D floorstanding decoration.
H:1.6 W:2.15 D:1.2 m.
❄️

2 204649 PETIT RENNE
3D floorstanding decoration.
H:1.4 W:1.35 D:0.6 m.
❄️

5 204637 WAGON
3D floorstanding decoration.
H:0.6 W:1.5 D:1 m.
❄️ Ⓞ

3 204634 AVION
3D floorstanding decoration.
H:1.4 W:2.65 D:2.6 m.
❄️

6 204635 MAISON BISCUIT
3D floorstanding decoration.
H:2 W:1.8 D:1.6 m.
❄️



7



8



9



10

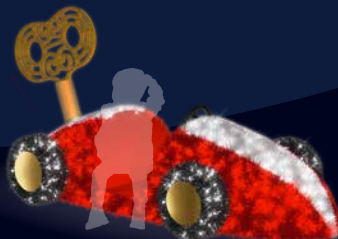

11

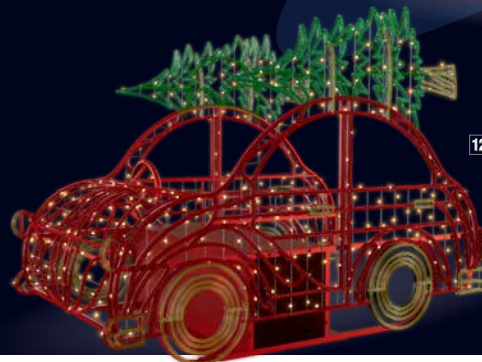

12

7 204633 FUSÉE
3D floorstanding decoration.
H:2.2 W:1.4 D:0.9 m.



8 205446 GRANDE ROUE
3D floorstanding decoration.
H:6 W:5.45 D:3.5 m.



9 204631 BATEAU PIRATE
3D floorstanding decoration.
H:2.7 W:2.5 D:1.3 m.



10 205265 CHEVAL À BASCULE
3D floorstanding decoration.
H:0.9 W:1 D:0.25 m.



11 204632 VOITURE DE COURSE
3D floorstanding decoration.
H:0.95 W:2.05 D:0.85 m.



12 205268 AUTOMOBILE
3D floorstanding decoration.
H:1.4 W:2 D:0.7 m.



Gourmet Decorations



Scan this QR-Code to discover
our gourmet decor creations.







1 205054 MACARONS
3D floorstanding decoration.
H:2.25 W:2.35 D:1.5 m.
✱

2 205059 CADEAUX FESTIFS
3D floorstanding decoration.
H:3 W:2.23 D:2.16 m.
✱

3 205062 CARROUSEL MACARONS
3D floorstanding decoration.
H:4.4 W:4 D:4 m.
✱

4 205056 TROIS SUCETTES
3D floorstanding decoration.
H:3 W:2 D:1.5 m.
✱ Ⓞ

5 205057 SUCETTE
3D floorstanding decoration.
H:2.3 W:1.5 D:1.1 m.
✱ Ⓞ



6

6 205064 PETIT CÔNE GOURMAND
3D floorstanding decoration.
H:4 W:2.5 D:2.5 m.



7

7 205060 BIG CAKE
3D floorstanding decoration.
H:4.5 W:4 D:4 m.



9

9 205058 SUCRES D'ORGE
3D floorstanding decoration.
H:3.7 W:3.75 D:1.1 m.



8

8 205063 CÔNE GOURMAND
3D floorstanding decoration.
H:11 W:6.5 D:6.5 m.

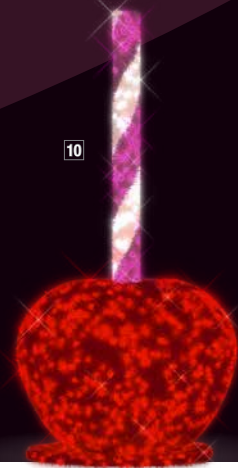

10

10 205055 POMME D'AMOUR
3D floorstanding decoration.
H:3 W:1.5 D:1.5 m.



* NEW

Please note: optional accessories required for installation



1 205584* M BISCUIT
 3D floorstanding decoration.
 H:1.8 W:1.25 D:0.3 m.
 ✨

2 205061 CUPCAKE
 3D floorstanding decoration.
 H:6 W:5.73 D:5.73 m.
 ✨ Ⓞ

3 203270 MAISON PAIN D'ÉPICE
 3D floorstanding decoration.
 H:4.22 W:3.68 D:4.2 m.
 ✨

4 203271 ÉTOILE PAIN D'ÉPICE
 3D floorstanding decoration.
 H:2.1 W:2.5 D:0.8 m.
 ✨

5 205053 BOULE S
 3D floorstanding decoration.
 H:1.8 W:1.8 D:1.8 m.
 ✨

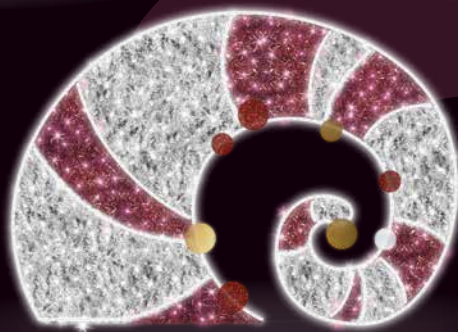

6 205051 ARCEAU CANDY L
2D floorstanding decoration.
H:1.5 W:2 m.



8 205048 ARCEAU CANDY XL
2D floorstanding decoration.
H:1.75 W:2 m.



20 205049 ARCEAU MUFFIN
2D floorstanding decoration.
H:1.5 W:1.3 m.



18 205052 ARCEAU SPIRALE
2D floorstanding decoration.
H:1.4 W:2 m.



19 205050 ARCEAU CANDY M
2D floorstanding decoration.
H:1.4 W:1.5 m.



Letterboxes & Characters



Scan this QR-Code to find out more about our letterboxes & characters.







1 204641 PÈRE NOËL FUNKY
3D floorstanding decoration.
H:1.7 W:1.3 D:1 m.
❄️

2 205267 SANTA
3D floorstanding decoration.
H:2.8 W:1.7 D:1.7 m.
❄️

3 205262 PÈRE NOËL CADEAU
3D floorstanding decoration.
H:2.65 W:1.2 D:1.2 m.
❄️

4 203429 M. NOËL
3D floorstanding decoration.
H:3.4 W:2.55 D:2.6 m.
❄️

5 205614* PÈRE NOËL CHOUPI
3D floorstanding decoration.
H:2.15 W:2 D:1.6 m.
❄️

6 204648 BOÎTE NOËL
3D floorstanding decoration.
H:1.45 W:0.7 D:0.75 m.
❄️

7 201744 BOÎTE AUX LETTRES
3D floorstanding decoration.
H:1.5 W:1 D:0.6 m.
❄️

8 202675 TRAINOSSIMO
3D floorstanding decoration.
H:1.8 W:2.1 D:1.1 m.
❄️



9 204658 CHAPIN DE NOËL
3D floorstanding decoration.
H:4.4 W:4.3 D:3.3 m.
✻

10 205044 CASSE-NOISETTE
3D floorstanding decoration.
H:2.6 W:0.8 D:0.8 m.
✻

11 204657 AUGUSTIN LE LUTIN
3D floorstanding decoration.
H:3.7 W:2.35 D:2.45 m.
✻

12 204647 BOÎTE LUTIN
3D floorstanding decoration.
H:1.45 W:1.15 D:0.75 m.
✻

13 204654 NEIGE OUPS
3D floorstanding decoration.
H:1.3 W:0.8 D:0.8 m.
✻

14 202672 LA BOÎTE DES LUTINS
3D floorstanding decoration.
H:1.8 W:0.8 D:0.8 m.
✻



1 202709 POMPON
3D floorstanding decoration.
H:3.2 W:2.4 D:1.9 m.
❄️

2 205613* MR. NEIGE CHOUPI
3D floorstanding decoration.
H:2 W:2.3 D:2 m.
❄️

3 202378 LUTIN OUPS
3D floorstanding decoration.
H:1.8 W:1.45 D:0.8 m.
❄️

4 203075 BONHOMME DE NEIGE FUNKY
3D floorstanding decoration.
H:1.5 W:1.21 D:0.97 m.
❄️

5 205263 BOULLIZ'
3D floorstanding decoration.
W:1.2 H:1.2 D:1.2 m.
🟡🔴🟢

6 170754 KIT RUDY
2D floorstanding decoration.
H:1.3 W:1 m.

7 205264 BOULLIZ'
3D floorstanding decoration.
W:1.2 H:1.2 D:1.2 m.
🟡🔴🟢

8 170755 KIT FROSTY
2D floorstanding decoration.
H:0.9 W:1.7 m.

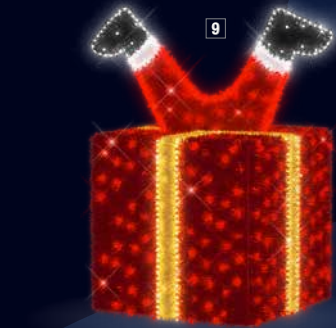

9 204656 PÈRE NOËL OUPS
3D floorstanding decoration.
H:1.4 W:0.8 D:0.8 m.



10 205609* BOULE CHOUPI
3D floorstanding decoration.
H:1.5 W:1.35 D:1.3 m.

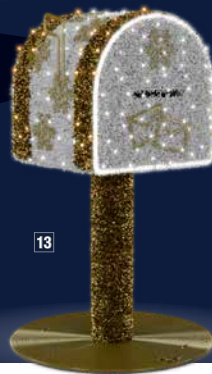

13 205261 BOÎTE DU PÈRE NOËL
3D floorstanding decoration.
H:1.5 W:1 D:1 m.



11 205615* GINGER CHOUPI
3D floorstanding decoration.
H:2 W:2 D:1.6 m.



14 205610* CADEAU CHOUPI
3D floorstanding decoration.
H:1.5 W:1.2 D:1.3 m.



12 205611* ÉTOILE CHOUPI
3D floorstanding decoration.
H:1.8 W:1.95 D:0.5 m.



* NEW

Please note: optional accessories required for installation

Animals



**Discover our animal creations
by scanning this QR-Code.**







1 203121 BOUQUETIN
GLACÉ
3D floorstanding decor.
H:5 W:4.47 D:1.93 m.
❄️

2 202884 PINGOO
3D floorstanding decor.
H:3 W:2.25 D:1.7 m.
❄️○○

3 203230 RUDOLPHE
3D floorstanding decor.
H:3.55 W:2.2 D:1.88 m.
❄️○○●

4 203122 RENNE
3D floorstanding decor.
H:3 W:2.2 D:0.95 m.
❄️

5 203176 RENNE COMÈTE
3D floorstanding decor.
H:2 W:1.49 D:0.63 m.
❄️○○●

6 205612* PINGOUIN
CHOUPI
3D floorstanding decor.
H:2.6 W:2 D:2 m.
❄️

7 203117 IGLOO
3D floorstanding decor.
H:1.3 W:3 D:3 m.
❄️

8 204792 CHEVAL
3D floorstanding decor.
H:2.1 W:2.6 D:0.6 m.
❄️○○

9 203118 CHAMOIS
3D floorstanding decor.
H:2.6 W:2.2 D:0.7 m.
❄️

10 205271 RENNES E-DECO
3D floorstanding decor.
H:1.5 W:1.12 D:1 m.
❄️○○●

11 205269 TRAINEAU
E-DECO
3D floorstanding decor.
H:1.2 W:2.6 D:1.1 m.
❄️⊙○○●



12 203436 RENNE FANTASTIQUE
3D floorstanding decoration.
H:6 W:5,2 D:4,3 m.
☼ Ⓞ ○ ● ● 📺

13 551212* RENNE FÉÉRIQUE
3D floorstanding decoration.
H:1,52 W:0,60 D:0,2 m.

14 551271* FAON FÉÉRIQUE
3D floorstanding decoration.
H:1 W:0,76 D: 0,24 m.
CROMEX

15 551272* CERF FÉÉRIQUE
3D floorstanding decoration.
H:1,66 W:1,35 D: 0,35 m.
CROMEX

16 551361* BICHE FÉÉRIQUE
3D floorstanding decoration.
H:1,30 W:1,10 D: 0,32 m.
CROMEX

17 205046 DAIM
3D floorstanding decoration.
H:3 W:1,9 D:0,8 m.
☼ ○ ●

18 203428 CARROUSEL DE NOËL
3D floorstanding decoration.
H:3 W:2,5 D:2,5 m.
☼ Ⓞ

* NEW

Please note: optional accessories required for installation



1 205274 GRAND PINGOO
3D floorstanding decoration.
H:5 W:3.75 D:2.83 m.
❄️⦿⦿

2 205275 GRAND RUDOLPHE
3D floorstanding decoration.
H:5.91 W:3.66 D:3.13 m.
❄️⦿⦿●

3 205278 RENNE FUNKY
3D floorstanding decoration.
H:2.1 W:1.3 D:1.1 m.
❄️⦿⦿●

4 205276 PINGOUIN FUNKY
3D floorstanding decoration.
H:1.5 W:1.32 D:1 m.
❄️⦿⦿

5 205277 OURS FUNKY
3D floorstanding decoration.
H:1.5 W:1.3 D:1.2 m.
❄️⦿⦿●

6 203083 BONNET
3D floorstanding decoration.
H:0.4 W:0.6 D:0.6 m.
❄️

7 203082 CRAVATE
3D floorstanding decoration.
H:0.56 W:0.16 D:0.08 m.

8 203076 ECHARPE
3D floorstanding decoration.
H:0.57 W:0.72 D:0.8 m.

9 203077 PARAPLUIE
3D floorstanding decoration.
H:0.69 W:0.34 D:0.27 m.



10 203084 CHAPEAU
3D floorstanding decoration.
H:0.44 W:0.8 D:0.8 m.
❄️

11 203079 COURONNE
3D floorstanding decoration.
H:0.3 W:0.55 D:0.55 m.
❄️

12 203078 CACHE OREILLE
3D floorstanding decoration.
H:0.4 W:0.73 D:0.3 m.
❄️

13 203080 NCEUD PAPILLON BOUL
3D floorstanding decoration.
H:0.21 W:0.58 D:0.18 m.

14 203081 CANNE
3D floorstanding decoration.
H:0.7 W:0.08 D:0.2 m.

15 203153 LUNETTES
3D floorstanding decoration.
H:0.18 W:0.53 D:0.2 m.

16 205616* OURSON CHOUP
3D floorstanding decoration.
H:3.3 W:3.3 D:2.4 m.
❄️

17 202708 NOUGAT
3D floorstanding decoration.
H:3.3 W:2.35 D:2.5 m.
❄️

*** NEW**

Please note: optional accessories required for installation

Gifts & Baubles



Scan this QR-Code to find out more about our gifts and baubles







1 203185 BULLE DORÉE
3D floorstanding decoration.
H:4.5 W:4.5 D:4.05 m.
☀️ Ⓞ ○ ○ ●

2 202810 CHRISTMAS BAUBLE XL
3D floorstanding decoration.
H:3.4 W:2.95 D:2.95 m.
☀️ ○ ○ ● ● ●

3 204707 BOULE ETOILÉE
3D floorstanding decoration.
H:3.45 W:4 D:4 m.
☀️ Ⓞ ○ ○ ● ●

4 203885 BOULE L
3D floorstanding decoration.
H:3 W:3 D:3 m.
☀️ ○ ○ ● ● ● Ⓞ

5 205576* GROS CADEAU
3D floorstanding decoration.
H:3 W:2 D:2 m.
☀️ ○ ○ ●

6 205578* CADEAU COUCHÉ
3D floorstanding decoration.
H:1.5 W:2 D:1 m.
☀️ ○ ○ ●

7 202724 CADEAU
3D floorstanding decoration.
H:1 W:1.35 D:1 m.
☀️ ○ ○ ● ● ●

8 203880 BOULE M
3D floorstanding decoration.
H:2.1 W:2 D:2 m.
☀️ ○ ○ ● ● ● Ⓞ



9 204754 CADEAU M
3D floorstanding decoration.
H:7.8 W:3.55 D:3.55 m.
☀️ ○ ○ ○ 📺

10 203837 CADEAU
3D floorstanding decoration.
H:3.8 W:3.75 D:3.75 m.
☀️ ○ ○ ○ 📺

11 205573* MAXI CADEAU
3D floorstanding decoration.
H:4 W:3.4 D:3.4 m.
☀️ ○ ○ ● ●

12 204753 CADEAU S
3D floorstanding decoration.
H:3.8 W:3.2 D:3.2 m.
☀️ ○ ○ ○ 📺

13 203874 BOULE S
3D floorstanding decoration.
H:2.1 W:1.8 D:1.8 m.
☀️ ○ ○ ● ● ● ● 📺

14 205581* MINI CADEAU
3D floorstanding decoration.
H:1 W:1 D:1 m.
☀️ ○ ○ ●

15 203891 BOULE DÉCO
3D floorstanding decoration.
H:3 W:1.5 D:1.4 m.
☀️ ○ ○ ● ● ● ● 📺

*** NEW**

Please note: optional accessories required for installation

Trees



Scan this QR-Code to find out more about our tree projects.







1

- 1 204769 SAPIN
DIAMANT L
3D floorstanding decoration.
H:8 W:6.15 D:6.15 m.
❄️ ⬤ ○ ● ◻



2

- 2 204780 SAPIN
FLOCONS M
3D floorstanding decoration.
H:6 W:3.1 D:3.1 m.
❄️



3

- 3 205235 CIMIER GIVRE
2D floorstanding decoration.
H:1.41 W:0.45 m.
❄️ ○ ○

4

- 4 205433 SAPIN GIVRE 8P
3D floorstanding decoration.
H:6 W:3.6 D:3.6 m.
❄️ Ⓞ ○ ○

6

- 6 203756 SAPIN
LOUISE SOCLE
3D floorstanding decoration.
H:6.1 W:4 D:4 m.
❄️ Ⓞ ○ ● ●



5

- 5 203189 CÎMIER
CÔNE GIVRÉ
2D floorstanding decoration.
H:0.85 W:0.87 m.



7 203364 PETIT ALYA
3D floorstanding decoration.
H:3 W:2 D:2 m.
❄️ Ⓞ ○ ● ● ● 📺

10 203374 PETIT AMAYA
3D floorstanding decoration.
H:1.5 W:1 D:1 m.
❄️ Ⓞ ○ ○ ●

8 205628* CÔNE ARLEQUIN
3D floorstanding decoration.
H:3.8 W:2.47 D:2.47 m.
❄️

11 205629* CÔNE ARLEQUIN
3D floorstanding decoration.
H:2 W:1.3 D:1.3 m.
❄️

9 204747 SAPIN BOULES
3D floorstanding decoration.
H:8 W:4.8 D:4.2 m.
❄️

*** NEW**

Please note: optional accessories required for installation



1 203258 ARBRE MAGIQUE
3D floorstanding decoration.
H:5 W:4 D:4 m.



2 204777 SAPIN ÉTOILÉ L
3D floorstanding decoration.
H:8 W:4.1 D:4.1 m.



3 203183 SAULE ENCHANTÉ 8P
3D floorstanding decoration.
H:5 W:6.16 D:6.16 m.



4 205625* CÔNE ESSENTIEL
3D floorstanding decoration.
H:10.17 W:3.82 D:3.82 m.



5 170866* KIT CÔNE ESSENTIEL PERSONNALISABLE
Edeco 2D Suspension.
H:10.17 W:3.82 D:3.82 m.

6 203375 POT ALYA
3D floorstanding decoration.
H:1.6 W:1.8 D:1.8 m.





7 205284 CIMIER MAGIE
2D floorstanding decoration.
H:1.4 W:0.63 m.
❄️ ⬤ ○ ○ ●

10 203187 CÔNE GIVRÉ
3D floorstanding decoration.
H:6 W:3 D:3 m.
❄️ ○ ○

8 205382 SAPIN MAGIE 8P
3D floorstanding decoration.
H:12 W:6.15 D:6.15 m.
❄️ Ⓞ ○ ○ ● ●

11 202499 SAPIN RUBAN
3D floorstanding decoration.
H:8 W:6.4 D:6.4 m.
❄️ ○ ○ ● 📺

9 204793 CÎMIER ÉTOILÉ
3D floorstanding decoration.
H:1 W:1 D:1 m.
❄️

12 203138 SAPIN PAILLETÉ
3D floorstanding decoration.
H:6 W:3 D:3 m.
❄️ ○ ○



1 205585* CÔNE FUNKY
3D floorstanding decoration.
H:5 W:3 D:2.7 m.
❄️

2 205225 CIMIER HOLLY
2D floorstanding decoration.
H:1.4 W:0.4 m.
❄️🟢

3 205417 SAPIN HOLLY 8P
3D floorstanding decoration.
H:10 W:5.45 D:5.45 m.
❄️🟢🟡

4 203435 GRAND SYLVESTRE
3D floorstanding decoration.
H:7.35 W:5.8 D:5.8 m.
❄️

5 204748 SYLVESTRE CADEAUX
3D floorstanding decoration.
H:11.25 W:7.45 D:9.1 m.
❄️

6 203174 SAPIN COURONNES
3D floorstanding decoration.
H:6 W:3 D:3 m.
❄️🟢

7 203041 SAUTOIR
3D floorstanding decoration.
H:1.75 W:3 D:3 m.
❄️🟡



8
12



9
13



11



10
14

8 205643* SAPIN ABBY XL
3D floorstanding decoration.
H:7.8 W:5.15 D:5.15 m.



9 205644* SAPIN ABBY L
3D floorstanding decoration.
H:5.75 W:3.75 D:3.75 m.



10 205646* SAPIN ABBY S
3D floorstanding decoration.
H:2 W:1.35 D:1.35 m.



11 204797 SAPIN CADEAUX XXL
3D floorstanding decoration.
H:12 W:6 D:6 m.



12 170871* KIT NŒUDS ABBY XL
Accessory.

13 170868* KIT BOULES ABBY L
Accessory.

14 170874* KIT NŒUDS ABBY S
Accessory.

* NEW

Please note: optional accessories required for installation

Infinity range

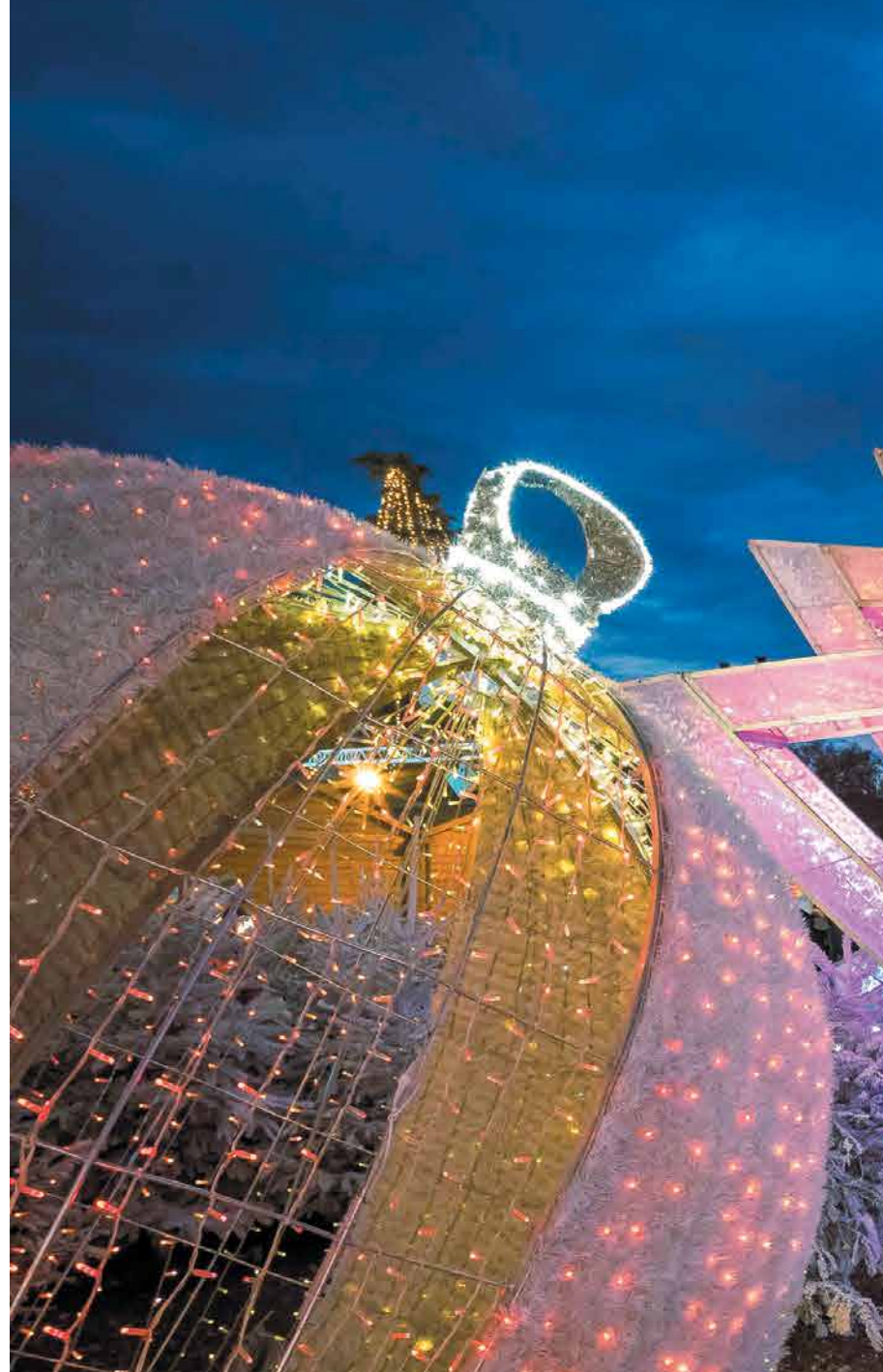





Pia • France



Saint-Jean-de-Luz • France



Levis Quai Paquet • Canada

Avondale • USA



Avondale • USA



Cleveland Metroparks Zoo • USA

Infinity







1 204706 KIOSQUE INFINITY
3D floorstanding decoration.
H:3 W:2.4 D:2.4 m.
☀️ Ⓞ ○ ○ ● ● 📺

2 203902 RUBAN INFINITY
3D floorstanding decoration.
H:5.25 W:4.5 D:4.5 m.
☀️

3 204788 CRYSTAL M INFINITY
3D floorstanding decoration.
H:7.8 W:5 D:3.7 m.
☀️ 📺

4 204790 CARROSSE INFINITY
3D floorstanding decoration.
H:3.85 W:5.1 D:3.1 m.
☀️ ○ ○ ● ● 📺

5 203879 BOULE M INFINITY
3D floorstanding decoration.
H:2.1 W:2 D:2 m.
☀️ ○ ○ ● ● 📺

6 203873 BOULE S INFINITY
3D floorstanding decoration.
H:2.1 W:1.8 D:1.8 m.
☀️ ○ ○ ● ● 📺

7 203847 SAPIN INFINITY
3D floorstanding decoration.
H:6.7 W:3.2 D:3.2 m.
☀️ ○ ● ● 📺

8 203713 ALYA INFINITY
3D floorstanding decoration.
H:5 W:3 D:3 m.
☀️ Ⓞ ○ ○ ● ● 📺

9 203836 CADEAU INFINITY
3D floorstanding decoration.
H:3.8 W:3.75 D:3.75 m.
☀️ ○ ○ ● ● 📺

10 203868 SPHÈRE S INFINITY
3D suspension.
H:0.5 W:0.5 D:0.5 m.
☀️ 📺 📺 📺



11 203834 SPIRALE INFINITY
3D floorstanding decoration.
H:5.2 W:8.4 D:5.2 m.
☀️ 🌈 📺

12 203722 RENNE FANTASTIQUE INFINITY
3D floorstanding decoration.
H:6 W:5.2 D:4.3 m.
☀️ ○ ○ 🌈 📺

13 203835 ÉTOILE INFINITY
3D floorstanding decoration.
H:5.2 W:7.85 D:4 m.
☀️ 🌈 📺

14 203900 CHARMILLE INFINITY B
3D floorstanding decoration.
H:2.5 W:1.2 D:0.85 m.
☀️ 🌈 📺

15 203857 CÔNE INFINITY
3D floorstanding decoration.
H:4.8 W:3.2 D:3.2 m.
☀️ 🌈 📺 📺

16 203899 CHARMILLE INFINITY A
3D floorstanding decoration.
H:2.5 W:1.2 D:1 m.
☀️ 🌈 📺

17 203901 CHARMILLE INFINITY C
3D floorstanding decoration.
H:2.5 W:1.2 D:1 m.
☀️ 🌈 📺

18 203890 BOULE DÉCO INFINITY
3D floorstanding decoration.
H:3 W:1.5 D:1.4 m.
☀️ ○ ○ 🌈 📺

19 205312 FONTAINE E-DECO
3D floorstanding decoration.
H:2.5 W:3.73 D:3.35 m.
☀️ 📺 🌈 📺

20 203884 BOULE L INFINITY
3D floorstanding decoration.
H:3 W:3 D:3 m.
☀️ ○ ○ 🌈 📺

21 203870 SPHÈRE L INFINITY
3D suspension.
H:1 W:1 D:1 m.
☀️ 🌈 📺 📺

22 203869 SPHÈRE M INFINITY
3D suspension.
H:0.7 W:0.7 D:0.7 m.
☀️ 🌈 📺 📺

Modular decorations





FRAMES & BOULLIZ THROUGHOUT THE YEAR

Discover our frames and our Boulliz collection, evolving and original decors.

Our Boulliz are made of a ball structure in various colours that can be quickly and easily personalised to create many characters to match the events of the year.



How does it work ?
Watch the video

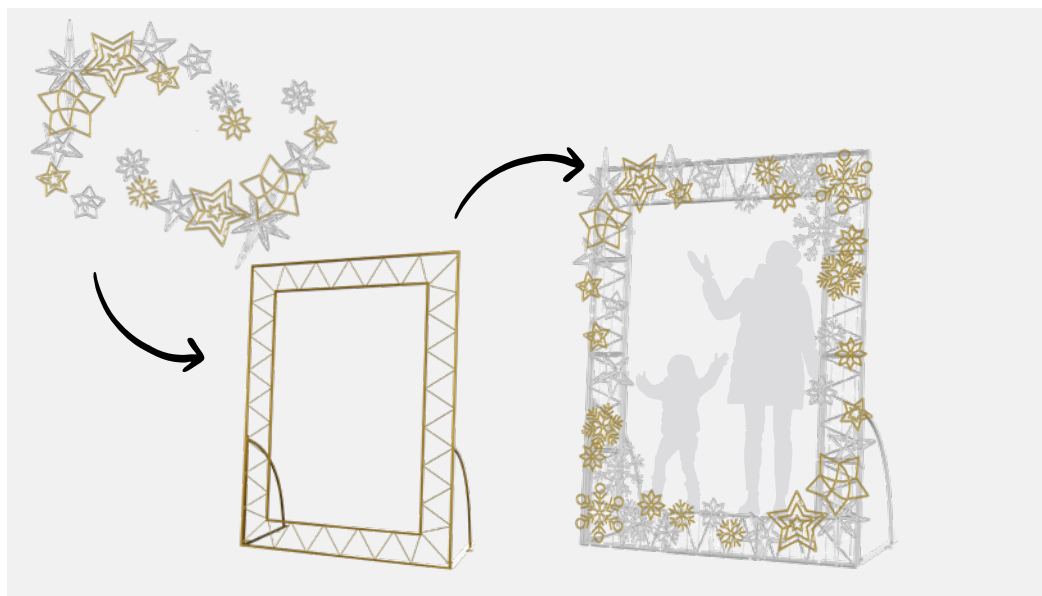
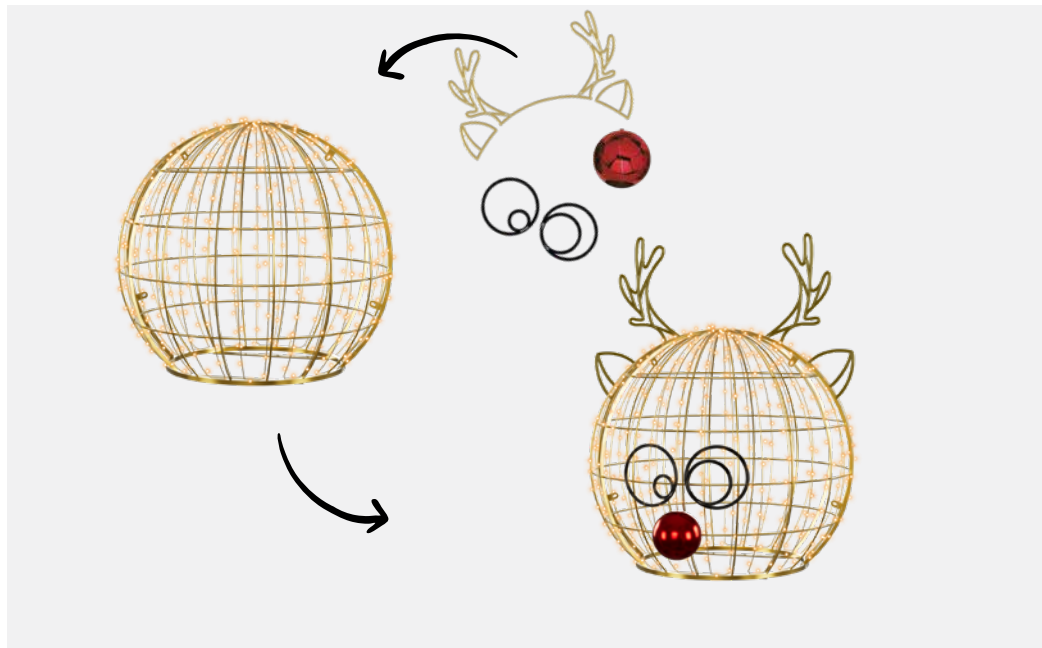

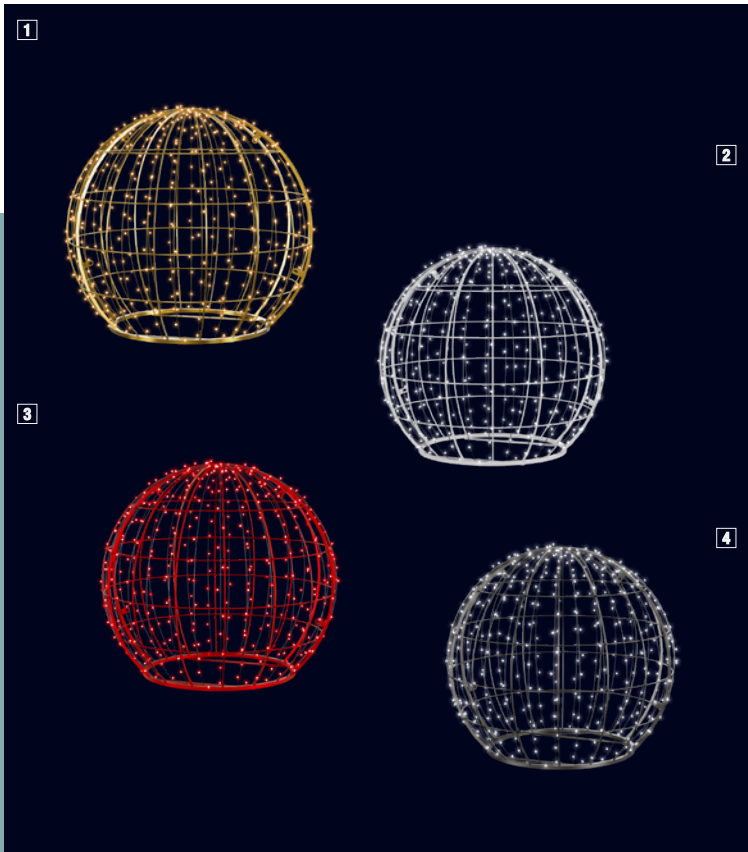

1 205263 BOULLIZ'
3D Floorstanding decoration.
W 1.2 x H 1.2 x D 1.2 m.
●●●●

2 205264 BOULLIZ'
3D Floorstanding decoration.
W 1.2 x H 1.2 x D 1.2 m.
●●●●

5 205039 CADRE PHOTO
Fixing Accessory.
W 2 x H 2.63 m.
Non luminous
●●

6 205040 CADRE PHOTO
Fixing Accessory.
W 2 x H 2.63 m.
Non luminous
●●

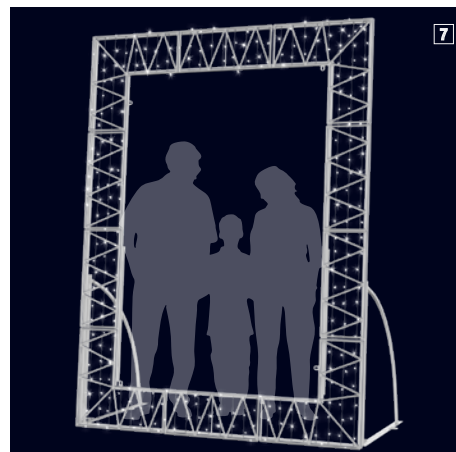

3 205352 BOULLIZ'
3D Floorstanding decoration.
W 1.2 x H 1.2 x D 1.2 m.
●●●●

7 205286 CADRE LUMINEUX
3D Floorstanding decoration.
W 2 x H 2.6 x D 0.9 m.
●●

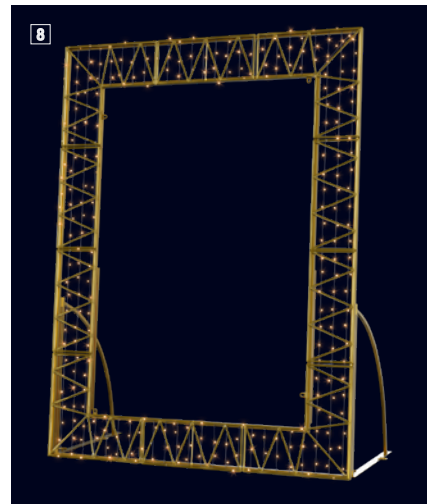

4 205251 BOULLIZ'
3D Floorstanding decoration.
W 1.2 x H 1.2 x D 1.2 m.
●●●●

8 205285 CADRE LUMINEUX
3D Floorstanding decoration.
W 2 x H 2.6 x D 0.9 m.
●●

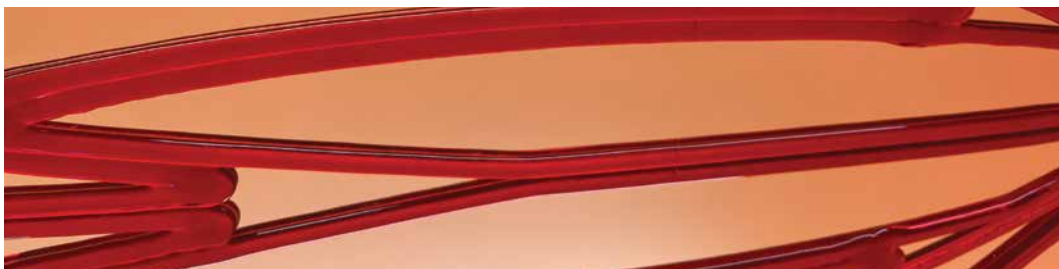

CUSTOMISABLE ARCHES

Throughout the year, personalise your structure with colourful e-deco kits to suit your events. Luminous or non-luminous, indoors or outdoors, decorate high-traffic areas and entrances to your venues. Your visitors will love capturing the moment with a selfie or group photo.



How does it work ?
Watch the video

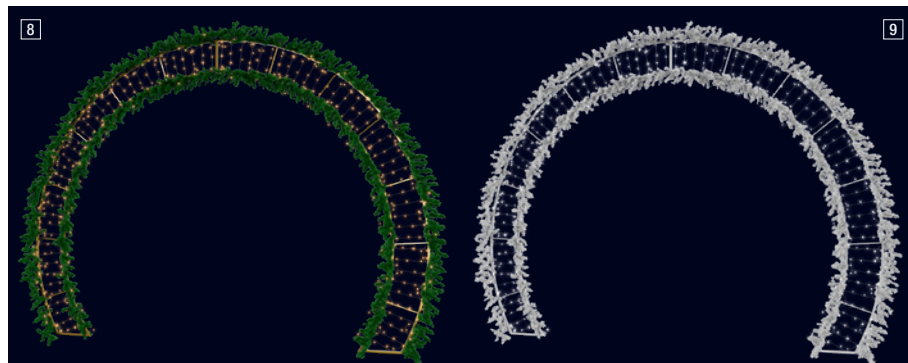
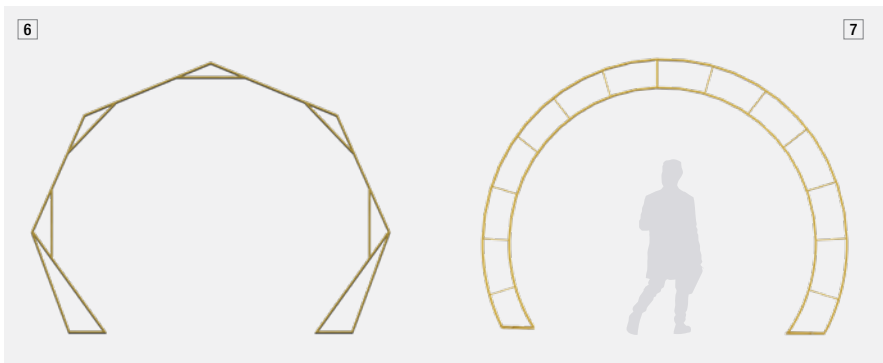
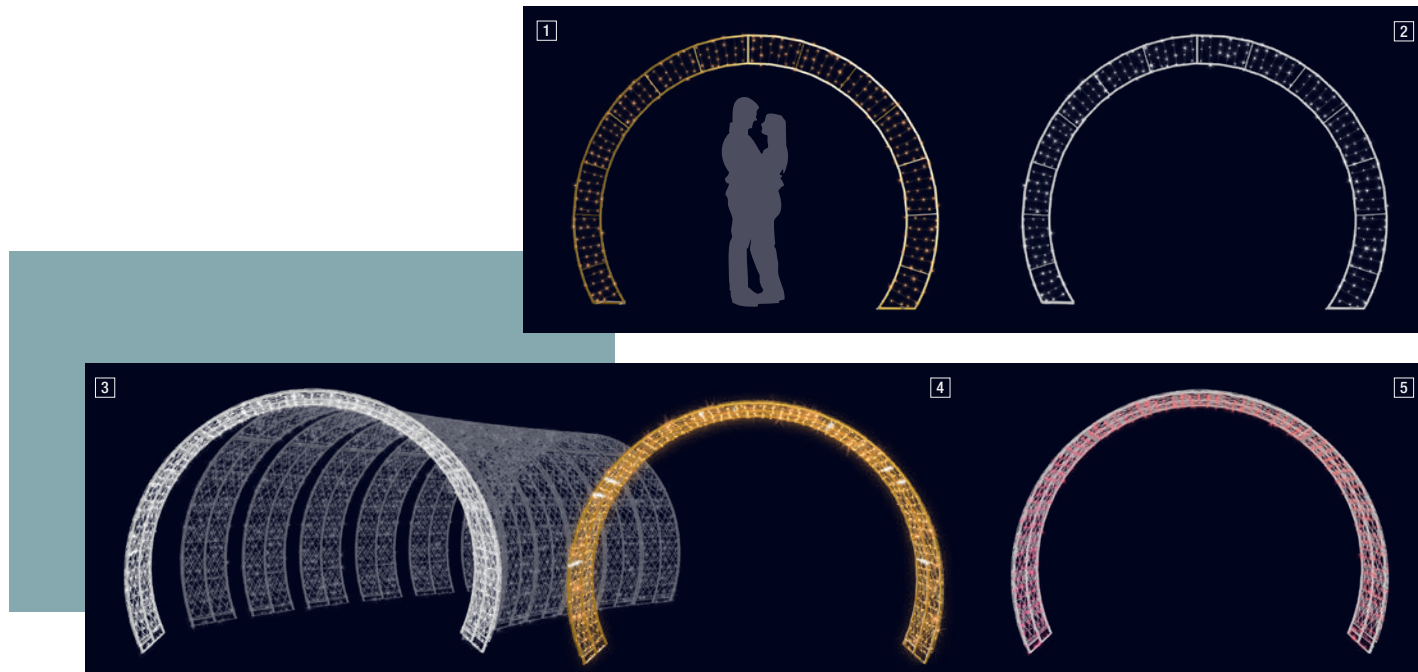

1 205288 ARCHE LUMINEUSE OR
3D Floorstanding decoration.
W 3.8 x H 2.8 m.
○○

2 205287 ARCHE LUMINEUSE BLANCHE
3D Floorstanding decoration.
W 3.8 x H 2.8 m.
○○

3 205280 ARCHE 3D BLANC
3D Floorstanding decoration.
W 4 x H 1 x D 2.75 m.
○○●■

4 205279 ARCHE 3D OR
3D Floorstanding decoration.
W 4 x H 1 x D 2.75 m.
○○●■

5 205281 ARCHE 3D INFINITY
3D Floorstanding decoration.
W 4 x H 1 x D 2.75 m.
○○●■

6 205037 ARCHE OR
Fixing Accessory.
W 3.6 x H 2.73 m.
Non luminous
○○

7 205105 ARCHE CIRCULAIRE OR
Fixing Accessory.
W 3.8 x H 2.8 m.
Non lumineux
○○

8 205618* ARCHE SAPINETTE VERT FONCÉ
3D Floorstanding decoration.
W 3.8 x H 2.8 m.
○○

9 205619* ARCHE SAPINETTE BLANC
3D Floorstanding decoration.
W 3.8 x H 2.8 m.
○○

*** NEW**

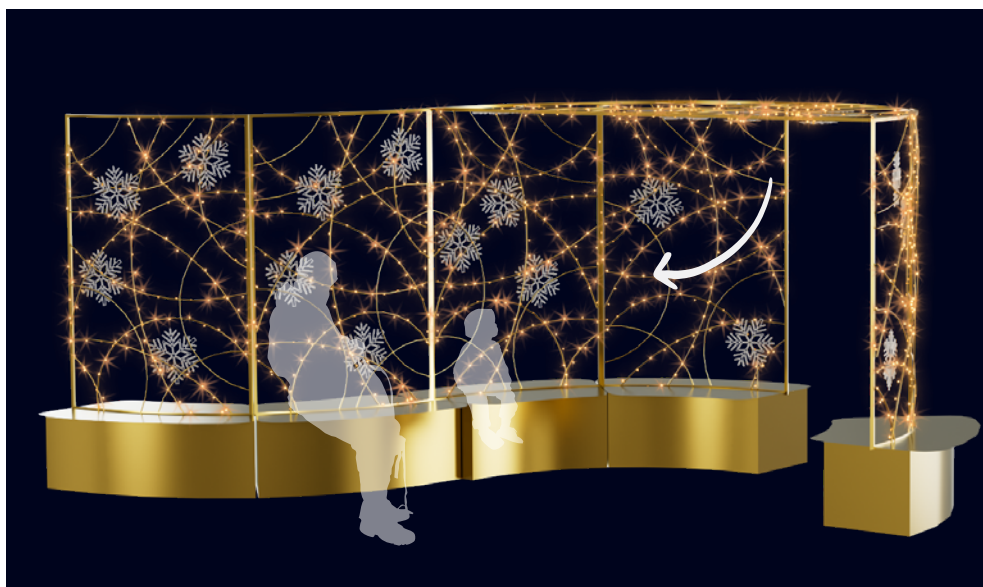
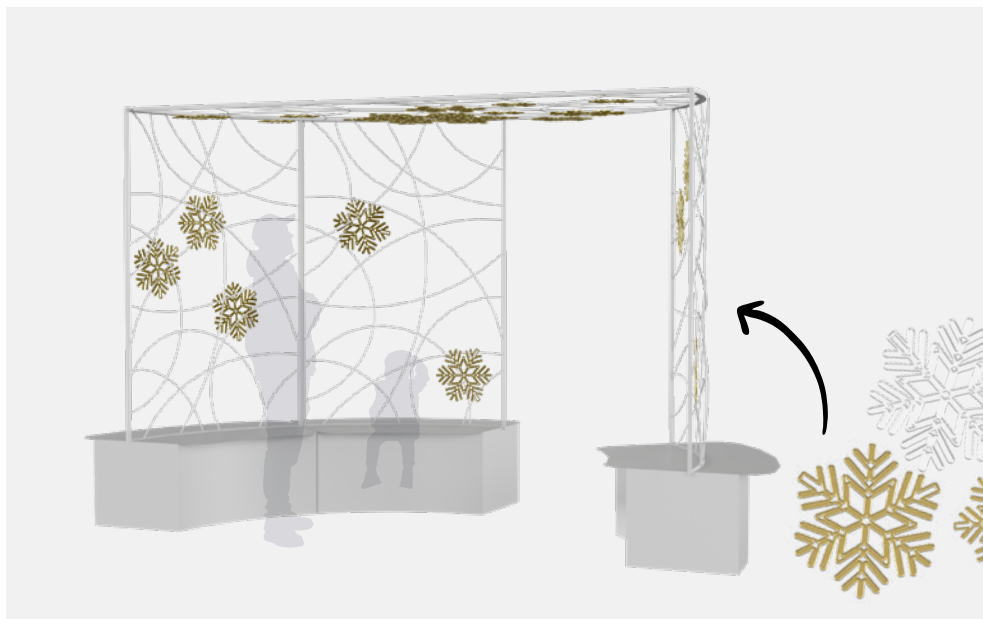

MAKE YOUR OWN DECORATION

Easily combine seats and ceilings to create your evolving decor. The Module Assise and Oriflamme collections can be adapted for all seasons and all occasions by dressing them up with the colourful e-deco elements of your choice !



How does it work ?
Watch the video

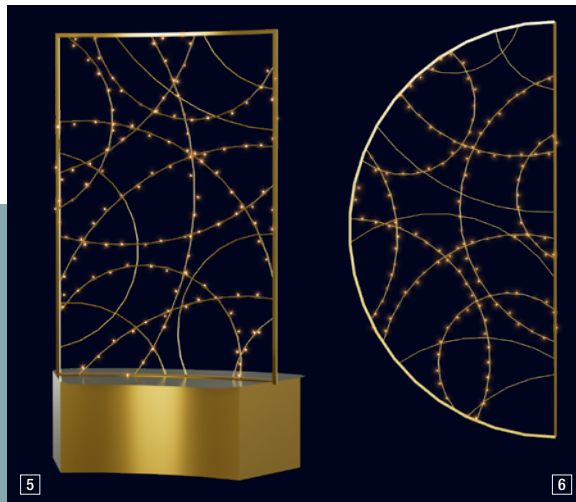
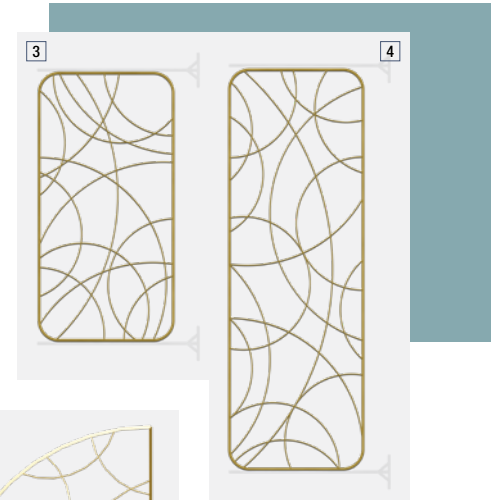
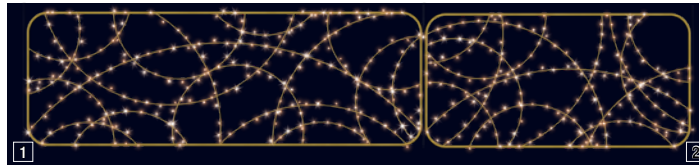
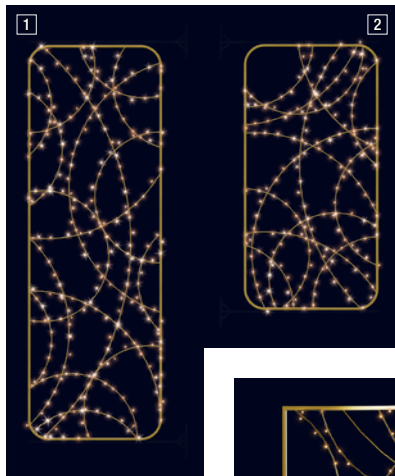

1 205251 ORIFLAMME

2D Lamp column
W 1 x H 3 m.



2 205250 ORIFLAMME

2D Lamp column
W 1 x H 2 m.



3 170823 ORIFLAMME

2D Lamp column
W 1 x H 2 m.

Non luminous



4 170824 ORIFLAMME

2D Lamp column
W 1 x H 3 m.

Non luminous



5 205282 MODULE ASSISE

3D Floorstanding decoration.
W 1.3 x H 2.2 x D 0.85 m.

Non luminous



6 205283 MODULE PLAFOND

2D Floorstanding decoration.
W 1.45 x H 2.9 m.



7 170801 MODULE ASSISE

3D Floorstanding decoration.
W 1.3 x H 2.2 x D 0.85 m.

Non luminous



8 170802 MODULE PLAFOND

2D Floorstanding decoration.
W 1.45 x H 2.9 m.

Non luminous



9 170803 MODULE BANC

3D Floorstanding decoration.
W 2.65 x H 2.15 x D 1 m.

Non-luminous - Bench not included



LETTERING

This suspension collection is compatible with all existing crossings and can also be adapted to those you already own. Add a joyful message to your town entrances, regardless of your current decor, and offer a festive touch while staying within your budget.



How does it work?
Watch the video



1 205627* MERRY CHRISTMAS
2D Suspension.
H:0.85 W:3.8 m.

2 205626* JOYEUSES FÊTES
2D Suspension.
H:0.85 W:3 m.



* NEW



GOLDEN NUMBERS AND LETTERS

2D floorstanding decorations - H 1.70 m

Requires 2 concrete pads ref.032327 per reference, or stakes ref.600171.



REFERENCE	DESIGNATION	WIDTH
204799-24V	Golden Letter A	1.86 m
204800-24V	Golden Letter B	1.30 m
204801-24V	Golden Letter C	1.46 m
204802-24V	Golden Letter D	1.48 m
204803-24V	Golden Letter E	1.31 m
204804-24V	Golden Letter F	1.31 m
204805-24V	Golden Letter G	1.38 m
204806-24V	Golden Letter H	1.44 m
204807-24V	Golden Letter I	0.64 m
204808-24V	Golden Letter J	1.42 m
204809-24V	Golden Letter K	1.47 m
204810-24V	Golden Letter L	1.32 m
204811-24V	Golden Letter M	1.80 m
204812-24V	Golden Letter N	1.43 m
204813-24V	Golden Letter O	1.70 m
204814-24V	Golden Letter P	1.18 m
204815-24V	Golden Letter Q	1.71 m
204816-24V	Golden Letter R	1.31 m
204817-24V	Golden Letter S	1.31 m



NUMBERS AND CAPITAL LETTERS

2D floorstanding decorations - H 1.80 m

Requires 2 concrete pads ref.032327 per reference, or stakes ref.600171.



REFERENCE	DESIGNATION	WIDTH	REFERENCE	DESIGNATION	WIDTH
204932-24V	A Capital BF	1.85 m	204982-24V	Number 0 BF	1.53 m
204933-24V	B Capital BF	1.61 m	204958-24V	Number 1 BF	0.93 m
204934-24V	C Capital BF	1.62 m	204959-24V	Number 2 BF	1.47 m
204935-24V	D Capital BF	1.44 m	204960-24V	Number 3 BF	1.43 m
204936-24V	E Capital BF	1.47 m	204961-24V	Number 4 BF	1.55 m
204937-24V	F Capital BF	1.36 m	204962-24V	Number 5 BF	1.50 m
204938-24V	G Capital BF	1.77 m	204963-24V	Number 6 BF	1.47 m
204939-24V	H Capital BF	1.69 m	204964-24V	Number 7 BF	1.44 m
204940-24V	I Capital BF	0.53 m	204965-24V	Number 8 BF	1.47 m
204941-24V	J Capital BF	1.49 m	204966-24V	Number 9 BF	1.47 m
204942-24V	K Capital BF	1.84 m	204967-24V	Hashtag BF	1.47 m
204943-24V	L Capital BF	1.36 m			
204944-24V	M Capital BF	2.03 m			
204945-24V	N Capital BF	1.69 m			
204946-24V	O Capital BF	1.80 m			
204947-24V	P Capital BF	1.61 m			
204948-24V	Q Capital BF	1.92 m			
204949-24V	R Capital BF	1.67 m			
204950-24V	S Capital BF	1.53 m			
204951-24V	T Capital BF	1.61 m			
204952-24V	U Capital BF	1.61 m			
204953-24V	V Capital BF	1.79 m			
204954-24V	W Capital BF	2.42 m			
204955-24V	X Capital BF	1.86 m			
204956-24V	Y Capital BF	1.89 m			
204957-24V	Z Capital BF	1.59 m			



Installation

All our decorations are made with 100% LED.

They come with power cables, but without bulbs or satilights.
All our floorstanding 3D decorations are wired in SELV.





FASTENING ACCESSORIES FOR ACROSS STREET

ACROSS STREET

REF.	DESCRIPTION	COMPOSITION
113010	Wall/wall kit (for Ø 6 mm cable)	2 capstan screws M12, 2 tensioners, 2 alpine karabiners 100 mm, 2 shackles, 6 cable grip, 2 wall plates - Kits delivered without cable
113020	Wall/lamp column kit (for Ø 6 mm cable)	2 tensioners, 2 alpine karabiners 100 mm, 2 shackles, 6 cable grip, 1 post plate + 1 wall plate + 2 capstan screws - Kits delivered without cable
113030	Lamp column/lamp column kit (for Ø 6 mm cable)	2 tensioners, 2 alpine karabiners 100 mm, 2 shackles, 6 cable grip, 2 post plates + 2 capstan screws M12 - Kits delivered without cable
031855	Wall plate	Supplied by unit
031852	Capstan screws	1 ring, 1 screws de 12 x 20 mm
100504	Tensioner	Supplied by unit - 235 kg maxi
031895	Alpine karabiners 100 mm	Supplied by 10, Ø 10 mm
122900	Shackles	Supplied by 10 for 6 mm cable
101500	Cable grips 6 mm	Supplied by 10
060726	Steel cable 4 mm (sleeve at 6 mm)	Length 100 m - 1 260 kg maxi. break load
100503	Shackles	Supplied by 10
031990	Fastening kit	1 nut, 1 washer, 1 capstan screw M12, 1 alpine karabiner 100 mm - 930 kg max.

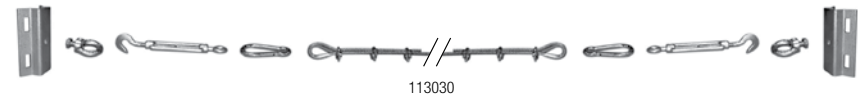
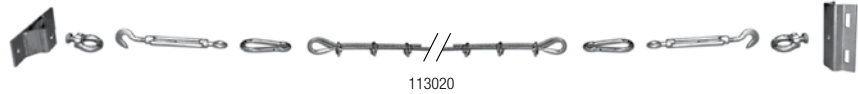
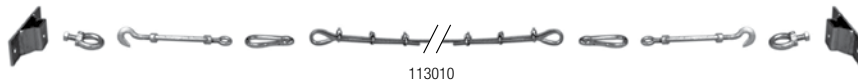

SUSPENSIONS

REFERENCE	DESCRIPTION	COMPOSITION
032197	Rapid fix clip	1 self-locking system, 1 Gripple, 1 M10 tip fillet, 2 nuts, 2 Ø 10 mm washers, 1 Ø 2 mm x 1.15 m galvanised cable, 1 flag Key (Gripple). For use with 6 mm galvanised cable (sleeved or unsleeved) - 45 kg max
050768	Sling 1 m	Maximum load 15 kg - Indoor only
050769	Sling 3 m	Maximum load 15 kg - Indoor only
051039	Sling 2 m	Maximum load 90 kg - Outdoor
032198	Suspension clip	1 self-locking system, 1 Ø 65 mm galvanised cable ring Ø 2 mm For use with 6 mm galvanised cable (sleeved or unsleeved). 45 kg maxi.



Bordeaux • France

FASTENING ACCESSORIES FOR LAMP COLUMN

Assemble in 3 stages:

- Choose a bracket according to the decoration width.
- Plan the hanging kit.
- Plan on the metal band and the clips.

BRACKETS

REFERENCE	DESCRIPTION	COMPOSITION
792001	Aluminium bracket 1 m	Supplied by unit - Maximum load 10 kg
792101	Aluminium bracket 1.20 m	Supplied by unit - Maximum load 10 kg
792201	Aluminium bracket 2 m	Supplied by unit - Maximum load 10 kg
032289	Aluminium bracket 1.20 m	Supplied by unit - Maximum load 40 kg

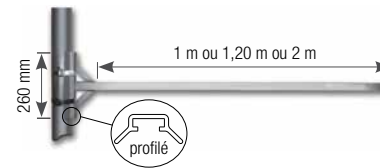

792001 / 792101 / 792201

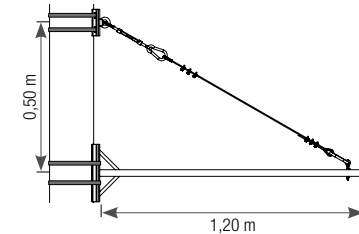

032289

SUSPENSIONS

REFERENCE	DESCRIPTION	COMPOSITION
792002	Hanging kit	4 alpine karabiners 60 mm, 2 eye hooks M6, 2 x 1 m chain, 2 washers Ø 6 mm, 2 nuts M6
032233	Suspension Kit M6	1 alpine karabiner 60 mm, 1 eye hook M6, 2 washers, 2 nuts M6
032220	Suspension Kit M10	1 alpine karabiner 100 mm, 2 Ø 10 mm washers, 2 nuts M10, 1 eye hook M10x70 mm
101640	Chain with soldered links	Length 1 m - 164 kg maxi
031894	Alpine karabiners 60 mm	Supplied by 10, Ø 6 mm



792002



032233 / 032220



101640



031894

STRAPS

REFERENCE	DESCRIPTION	COMPOSITION
032180	Strap	L 1 m x l 25 mm - Thickness : 2 mm -Tensioner included - 1 600 kg max
032361	Pliers for metal necklace	Pliers for metal necklace - Supplied by unit
032362	Metal necklaces	L 831 mm x l 19 mm - Supplied by 50



032180



032361



032362

PROTECTION AND SAFETY

REFERENCE	DESCRIPTION	COMPOSITION
722101	Support for concrete post	H 100 mm x W 300 mm - L element, shaped, suitable for any concrete post
032370	Silenbloc	Can be added to conventional attachments in the event of strong wind. Maximum load 10 kg
060637	Post plate protection	One side self-adhesive rubber foam strip - W 10 m x l 19 mm



722101



032370



060637

RAPID FIX SYSTEM

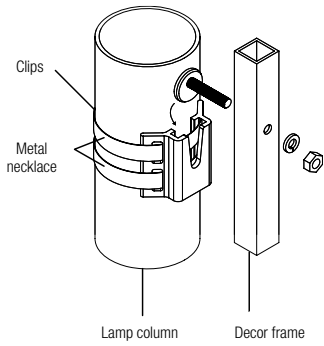

REFERENCE	DESCRIPTION	COMPOSITION
032242	4 sides Rapid Fix	4 plates with protection, 4 fastening parts, 4 washers, 8 nuts M10, 4 screws HM10x70, 8 washers Ø 10, 4 screws HM10x110
032094	Rapid Fix	1 plate, 1 fastening parts, 1 washer, 2 nuts M10, 1 screws HM10x70, 2 Ø 10 mm washers
032235	Wall plate Rapid Fix	1 plate, 1 fastening parts, 1 washer, 1 nut M10
032341	Multiple sides plate	Use to install a decoration in 4 or 8 sides, without a central pole.

The 4-sided Rapid Fix is suitable for cylindrical, hexagonal, or octagonal lamp columns with a diameter ranging from 100 mm to 200 mm. For other types of lamp columns, please contact us.

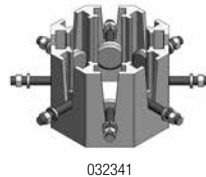
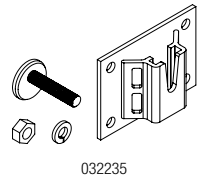
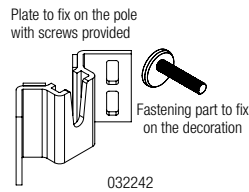
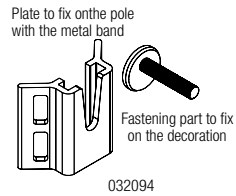

Aix en Provence • France

GRID CONNECTION



REF.	DESCRIPTION	COMPOSITION
300038*	Extension cable B+T	Bipolar + ground extension cable L 5 m - IP 44 Cable 3G1.5 mm ² H07RNF black - 16 A max.
300039*	Octopus B+T	Bipolar + ground octopus extension lead : 1 male end, 3 female ends. L 0.80 m - IP 44 Cable 3G1.5 mm ² H07RNF black - 16 A max.
059556	Angled connector cable	Cable with angled female connector for lamp column with connecting cable with bared end. L 6 m - ID 68 - Cable 3G1.5 mm ² H07RNF black - 20 A max.
059557	Cap for female connector	Cap for female connector, black with safety lead.
059558	Connecting cable L 2 m	Male cable with connecting cable with bared.

All Leblanc Illuminations decorations are delivered with power supply cables. You can find our various cables and accessories on the Plug & Light section p(266)



FASTENINGS FOR CIRCULAR DECORATIONS ON LAMP COLUMNS

REFERENCE	DESCRIPTION	COMPOSITION
031937	Simple crown Ø 600 mm	For pole Ø between 60 and 200 mm maximum.
031938	Simple crown Ø 800 mm	For pole Ø between 60 and 200 mm maximum.
031939	Crown extension Ø 600 mm	For pole Ø between 60 and 200 mm maximum. The crown extension enables installation of more curtain lights and animated cones.
031940	Crown extension Ø 800 mm	For pole Ø between 60 and 350 mm maximum. The crown extension enables installation of more curtain lights and animated cones.
031941	Big simple crown Ø 2 m	For pole Ø between 60 and 350 mm maximum.
031942	Big simple crown Ø 4 m	For pole Ø between 60 and 350 mm maximum.

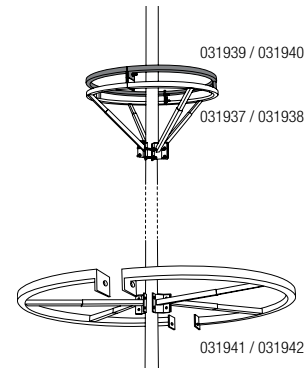

Bar le Duc • France

WEIGHT AND PACKING

NEW

REFERENCE	DESCRIPTION	COMPOSITION
600595*	Gold oval steel plate	Mounting base. L 190 x l 90 cm. 100 Kg. Gold. Provide 1 ref.370014 per plate.
600596*	White oval steel plate	Mounting base. L 190 x l 90 cm. 100 Kg. White. Provide 1 ref.370014 per plate.
600738*	Black circular steel plate	Mounting base. Ø 80 cm. 39 Kg. Black. Provide 1 ref.370014 per plate.
600700*	Black rectangular steel plate	Mounting base. L 100 x l 33 cm. 26 Kg. Black. Provide 1 ref.370014 per plate.
370014*	Steel plate screws	4 slings + screws - One Ref.370014 per steel plate.
300003	Square concrete pad - grey	Concrete pad - H 170 x W 700 mm - 200 Kg
300004	Sling	Sling for lifting of concrete pad 700x700, 1.2T max
032241	Concrete pad fastening kit	4 threaded studs M24, 8 nuts M24, 8 washers M24 Enables to set a pole on one or more blocks ref.032392 or ref.300003
032327	Rectangular concrete pad	H 170 x W 200 x D 400 mm - 28 kg - Grey
600171	Stake / Peg	Supplied by unit - W 500 mm
550495	Fastening line	Set of 10 - W 600 mm
550496	Securing tool kit	Driving tool, mandrin, laying plate and bracket
001949	Storage rack	Effective dimensions : W 1.78 x D 0.96 m
001948	4 candles	Height : 1.68 m

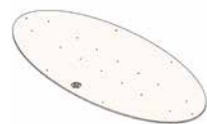

600595



300003



300004



032327



600171



001949 + 001948



550495



550496

The mooring line is strong, economical and quick to install.

Specially designed for stony ground, it avoids all the disadvantages of traditional anchoring systems.

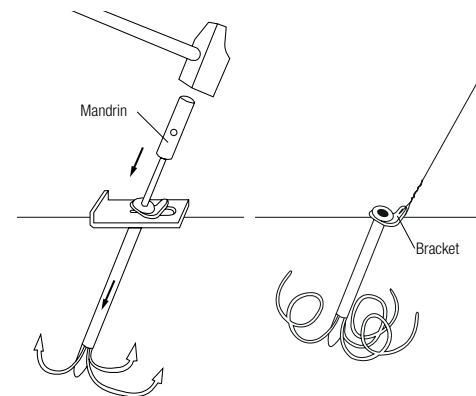

CREAFIX FLEXIBLE BARS

REFERENCE	DESCRIPTION	WIDTH	LENGTH
032275	Set of 4 Creafix bars	0,05 m	0,95 m
032274	Set of 10 multipurpose sliders for Creafix bars	-	-
059986	Threaded end for Creafix bars (2 ends + 1 threaded stud)	-	-
050475	Connector for Creafix flexible bar	-	-



032274



059986



050475

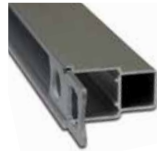

032275

Patented system

- Flexible mounting system for decorative lighting and/or items to be hung.
- Quicker, easier installation.
- Makes it easy to lay Plug & Light cables.
- Invisible cables.
- Sturdy.
- Can be used to create curtains, canopies and innovative shapes.



INDOOR FASTENINGS ACCESSORIES

REFERENCE	DESCRIPTION	COMPOSITION
100117	Spring double hook	Supplied by 50 - Perfect for attaching Xmas balls on motives (Ø 30 cm max)
100118	Chain	L 25 m - Maximum load 35 kg - Adaptable height
100119	Hooks C shape	Supplied by 100 - Quick and discreet fixing of hanging kits
100120	Hooks 8 shape	Supplied by 100 - For every hanging kit
401667	White barrier	Supplied by unit - White lacquered - W 1 x H 0.70 m
032358	Water bag	Perfect to stabilize floorstanding decorations without drilling (filled: 38 Kg)



032358



100117



100118



100119



100120

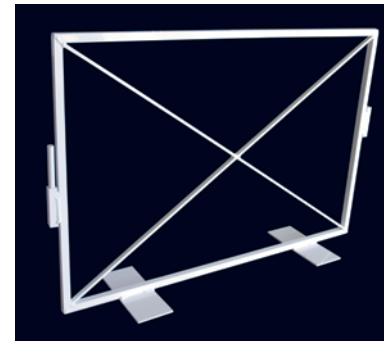

401667



FAULT-DETECTING SWITCH

FAULT-DETECTING PROTECTION CASE

REFERENCE	DESCRIPTION
010011	Fault-detecting protection case with manual reset



010011

- 1 bipolar plug + earth
- 30 mA circuit breaker
- 10 A fuse holder
- 1 earth terminal

ENERGY SAVER

REFERENCE	DESCRIPTION
010014	Energy saver



010014

- Enables stopping and restarting the illuminations in predefined periods : 7h stop after power, reset 6h (steady) after stopping.
- Automatic disconnection, automatic reset (guide UTE NF C17-210).
- 10 A - 2300 W - 300 mA.
- This product is designed to be mounted directly on plexo box sets, by yourself or in our factory.

IP54 ANIMATION CONTROLLERS

ANIMATION CONTROLLERS

REFERENCE	DESCRIPTION
105000	Flasher 1 x 5 A - Flasher with adjustable frequency
205000	Flasher 2 x 5 A - Flasher with adjustable frequency
010001	4 channels controller 5A - 10 programmes with adjustable frequency (from P0 to P9)
059708	2 channels controller with rectifier



Controller



Flasher

Programs :

- Coming and going between the two directions.
- Flashing between the two directions.
- Alternate blinking between the two directions, then simultaneous.
- Alternate flashing between the two directions, then simultaneous.

4 channels controller programs :

- P0 : scrolling
- P1 : P0 + Flash
- P2 : stacking
- P3 : P2 + Flash
- P4 : reverse scrolling
- P5 : P4 + Flash
- P6 : forward / back
- P7 : stacking / unstack
- P8 : reverse forward / back
- P9 : clignotement 1/2 et 3/4
- PA : P0+P2+P4+P1+P3
- PB : P5+P6+P7+P8+P9
- PC : flashing 1/2 and 3/4
- PD : PC + flash
- PE : 4 forward / back + flash
- PF : alternating scrolling

CABLE GLAND

REFERENCE	DESCRIPTION
031858	Cable gland - 1 seal and 1 nut



031858

Chromex,

Professional Quality at the Service of Lighting











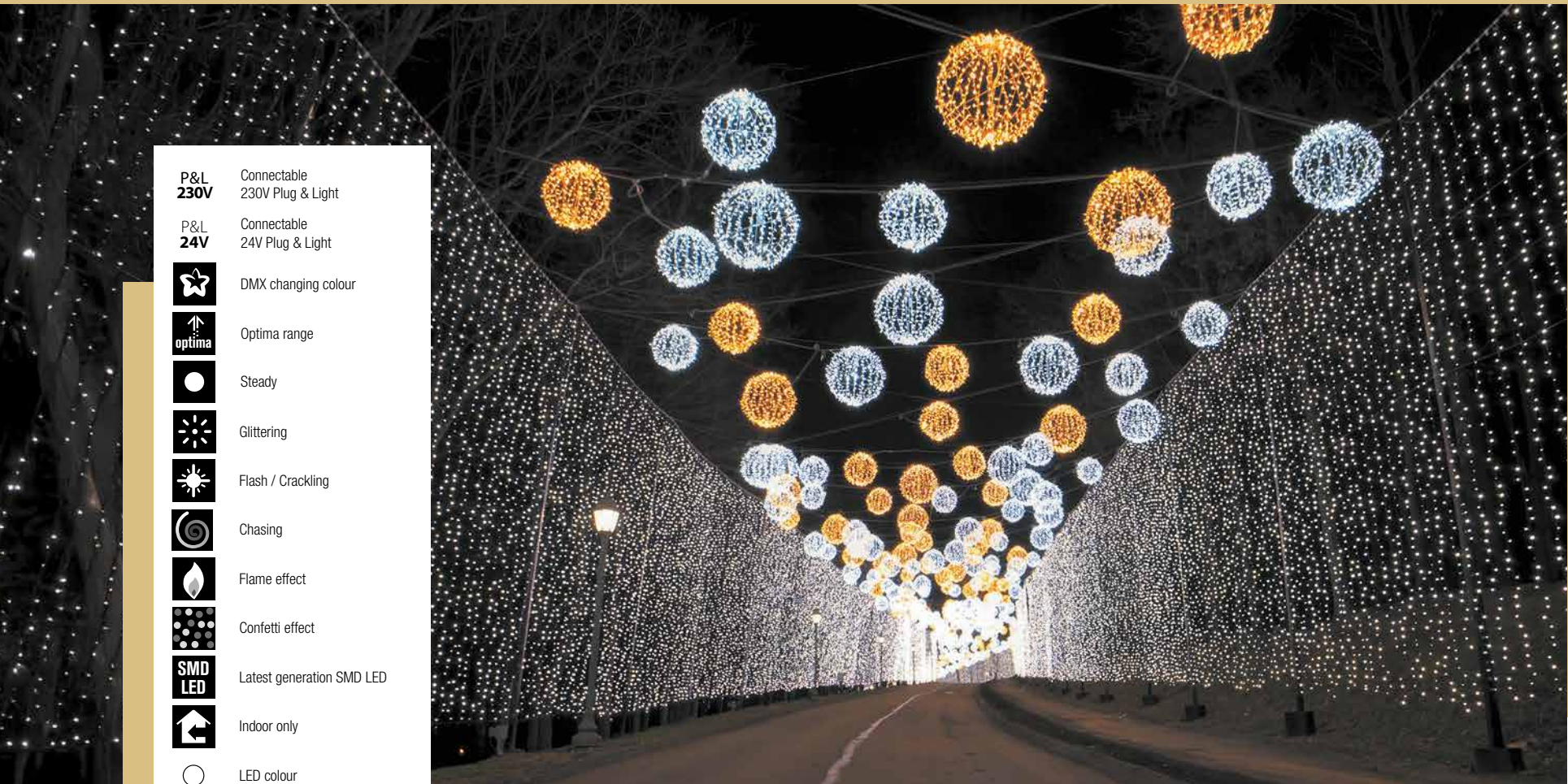





Since 1943, Chromex, a French brand of cables and garlands, has been a specialist in lighting equipment for cities and professionals. The brand combines professional, technological quality with ease of use. Its product ranges offer a blend of aesthetic design and low energy consumption.

PLACE YOUR ORDERS AT ONCE ON THE SPECIAL SHOPPING WEBSITE!

CHROMEX.FR





- P&L 230V** Connectable
230V Plug & Light
- P&L 24V** Connectable
24V Plug & Light
-  DMX changing colour
-  Optima range
-  Steady
-  Glittering
-  Flash / Crackling
-  Chasing
-  Flame effect
-  Confetti effect
-  Latest generation SMD LED
-  Indoor only
-  LED colour
-  Cable colour
-  New product

Lighting Solutions

TWINKLY PRO RANGE



Discover breathtaking animations



MODULE TWINKLY PRO MUSIC

This is a major innovation in the lighting industry.

100% LED and point-to-point controllable, Twinkly Pro represents the most significant technological advancement in the lighting decoration market in recent years. **Leblanc Illuminations is a distributor of Twinkly Pro controllable lights across Europe, the USA, and worldwide.**



Easily find all the products in the Twinkly Pro range thanks to this pictogram.

There are 4 different types of Twinkly Pro connectors:

- T10 connectors plug together (24V).
- T13 connectors plug together (24V).
- T15 connectors plug together (24V).

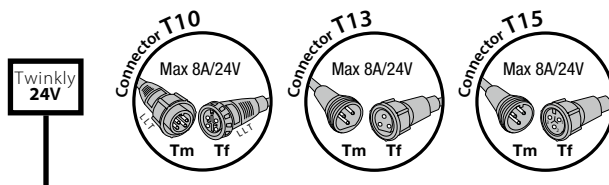

Find out more about Twinkly Pro controllers and connectors on the following pages.

24V



DC

REFERENCE	DESCRIPTION	CABLE
550965	Twinkly Pro Music Player	—

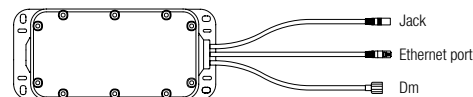

This new module will enable you to take the customization of your animations even further.

Use it to synchronize your video with your music on your Twinkly project.



In Saint Jean de Luz, Santa Claus honors the Basque Country and goes in search of the colors of Christmas



SPI TECHNOLOGY

Achieve the most spectacular shows with the new Twinkly SPI technology.

With SPI technology, you can install an unlimited number of Twinkly lighting products without having to multiply the controllers.

SPI	ETHERNET	WIFI
CONNECTIVITY	Ethernet	Bluetooth & WiFi
NB OF PORTS	2	1
NB MAX OF LED	2 000 LED max	Depending on the nb of products
MAX POWER	150 W max	48W max
INDEX OF PROTECTION	IP65	IP44

Example of cabling plan with ref. 551177:

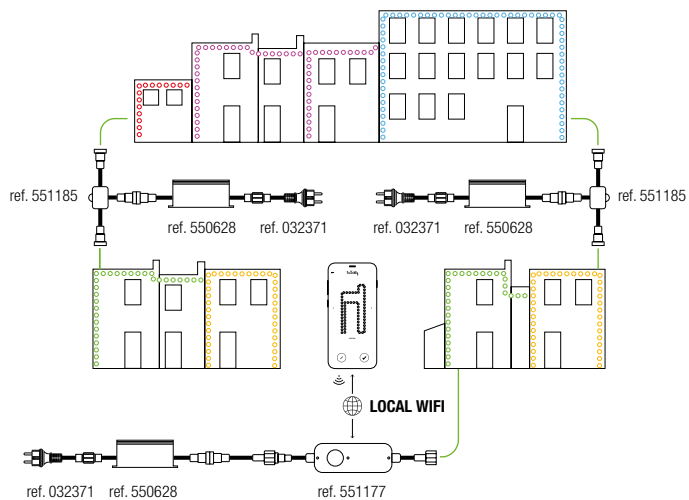

PLC TECHNOLOGY

The new generation of Twinkly LED string lights can be controlled point by point.

Thanks to its built-in Wi-Fi, you can access an infinite number of fully customizable effects.

Ref. 110023 : Allows you to connect up to 1,500 LEDs.

Ref. 550738 : Allows you to connect up to 500 LEDs, using the connector ref. 550740.

 PLC	ETHERNET	WIFI
CONNECTIVITY	Ethernet	Bluetooth & WiFi
NB OF PORTS	6	1
NB MAX OF LED	250 LED max	250 LED max
MAX POWER	150 W max	48W max
INDEX OF PROTECTION	IP65	IP44



Example of cabling plan with ref.110023 :

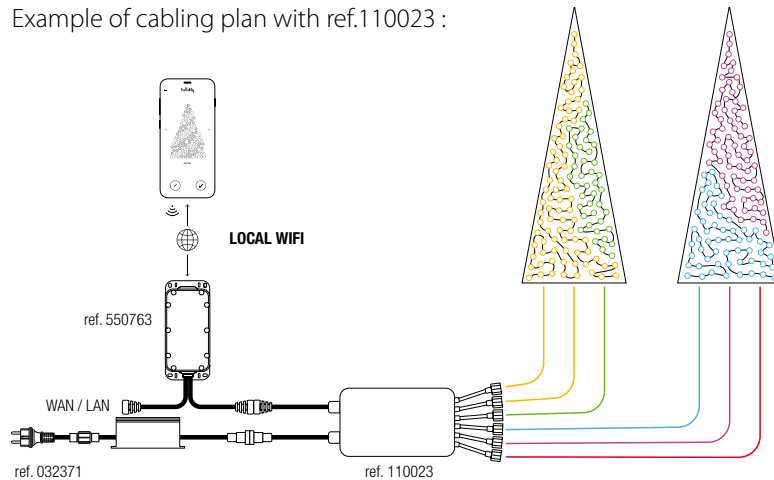

Example of cabling plan with ref. 550738:

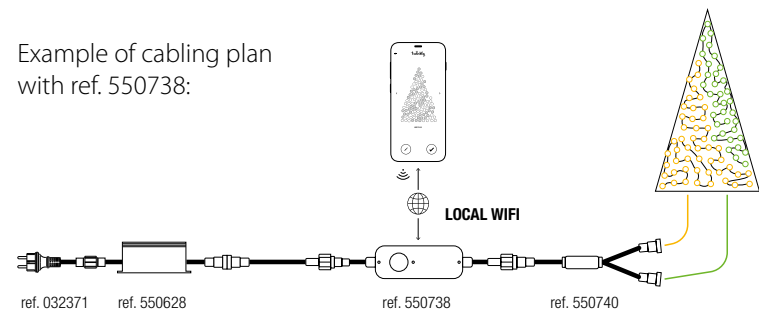

SPI CONTROLLERS & CONNECTORS

24V



REFERENCE	DESCRIPTION	LGT.
551176	Ethernet controller. 2 outputs. 2 000 pixels + 6.3 A output transformer	-
110026	Ethernet controller. 2 outputs. 2 000 pixels + 6.3 A output transformer + connectable P&W	-
551177	WiFi controller. 1 output	1 m

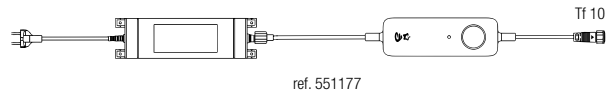
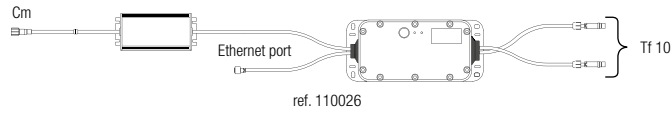

SPI ACCESSORIES

REFERENCE	DESCRIPTION	LGT.	CABLE
551186	4 A output transformer	-	—
551184	SPI extension cable	3 m	—
551185	SPI Injector	0.25 m	—

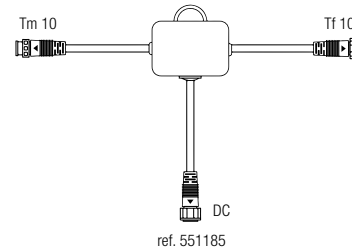
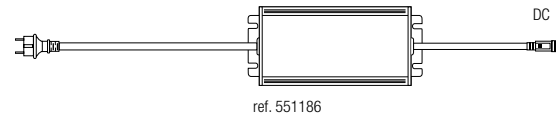

Synchronised Twinkly Pro modules and lights illuminate the facades and the Portofino tree.



CONTROLLABLE MODULES

24V



REFERENCE	DESCRIPTION	LENGHT	SPACING	NB MODULES	NB LED	LED	CABLE	P. / 230V
551178	A modules	60 cm	15 cm	5	10			10 W
551179	B modules	3.60 m	15 cm	25	50			38 W
551180	C modules	1.20 m	30 cm	5	10			10 W
551181	D modules	7.20 m	30 cm	25	50			38 W

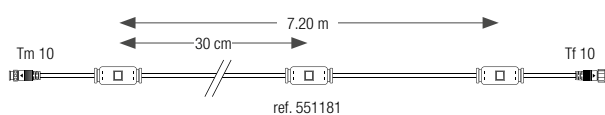
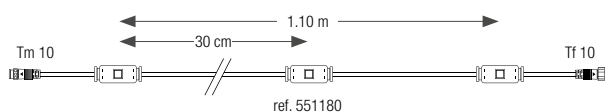
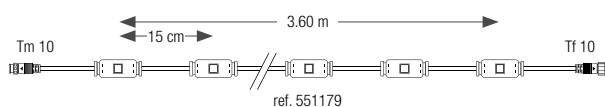
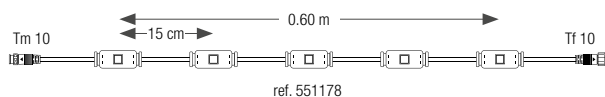

Point-by-point controllable modules.

An infinite number of fully customizable effects.

Connect up to 2,000 LEDs per controller via Ethernet. Easily extend your installation by 15 meters by adding a power supply and an Ethernet controller. With Wi-Fi, you can connect up to 750 LEDs per controller. Extend your installation by 9 meters by adding a power supply and a Wi-Fi controller.

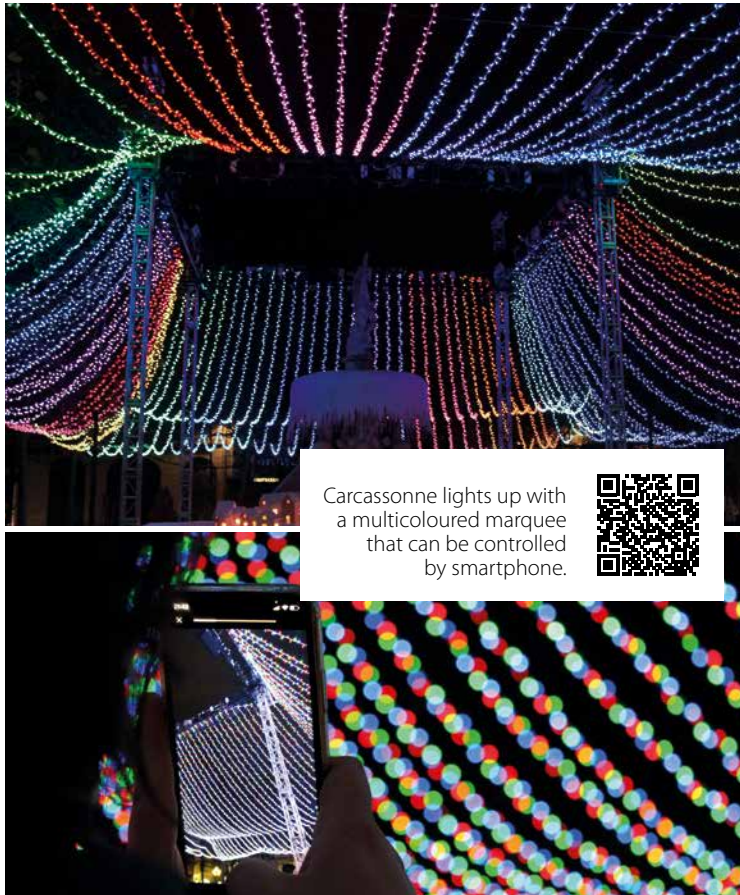

Carcassonne lights up with a multicoloured marquee that can be controlled by smartphone.



PLC ACCESSORIES

REFERENCE	DESCRIPTION	LGT.	CABLE
061218	Transformer 1.25 A max. output	-	—
061219	Transformer 2.5 A max. output	-	—
061220	Transformer 4 A max. output	-	—
550628	Transformer 6.25 A max. output	-	—
550336	Transformer 2x 6.25 A max. output	-	—
550739	Twinkly Pro Extension cable	5 m	—
550740	Y connector for WiFi controller	30 cm	—
550754	Adapter Tm Ø7 to Tf Ø13	15 cm	—
550762	Adapter Tm Ø13 to Tf 07	15 cm	—
032371	Power supply transformer	3 m	—
300029	Ethernet cable	5 m	—
300030	Ethernet cable	10 m	—
300031	Ethernet cable	15 m	—

PLC CONTROLLERS & CONNECTORS

24V



REFERENCE	DESCRIPTION	LGT.
551225	Ethernet controller. 6 outputs. 1 500 pixels + 6.3 A input	-
110023	Ethernet controller. 6 outputs. 1 500 pixels + 6.3 A input transformer + connectable P&W	-
550738	WiFi controller. 1 output. 500 RGB pixels	1 m
551009	WiFi controller. 4 outputs. 1000 RGB pixels	1 m
550763	WiFi Routeur - POE(1) 4G. IP65	1 m
550645	6 output Ethernet switch. POE(1). IP65	1 m

⁽¹⁾ Power Over Ethernet

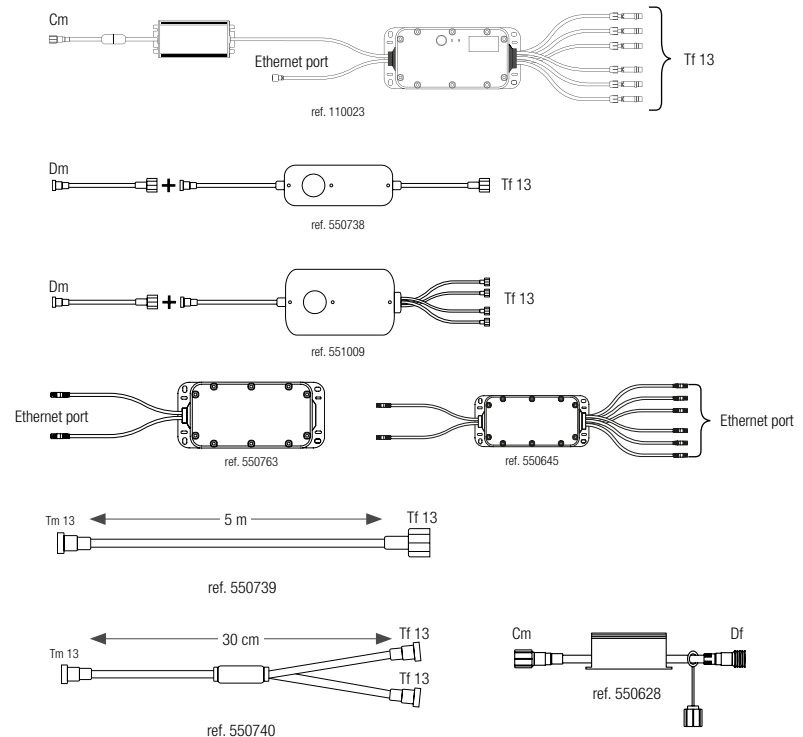



CONTROLLABLE CURTAINS

24V

PLC DC

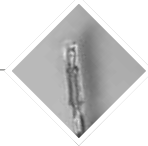

REFERENCE	DIMENSIONS	NB LED	LED	CABLE	P. / 230V
550741	H 4 x W 0.40 m	250			34.5 W
550742	H 4 x W 0.40 m	250			34.5 W
550743	H 4 x W 0.40 m	250			34.5 W

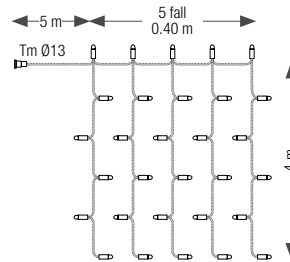

CONTROLLABLE ICICLE LIGHTS

24V

PLC DC

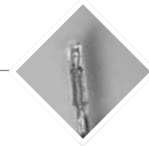

REFERENCE	DIMENSIONS	NB LED	LED	CABLE	P. / 230V
550966	H 0.70 x W 5 m	250			34.5 W
550968	H 0.70 x W 5 m	250			34.5 W
550967	H 0.70 x W 5 m	250			34.5 W

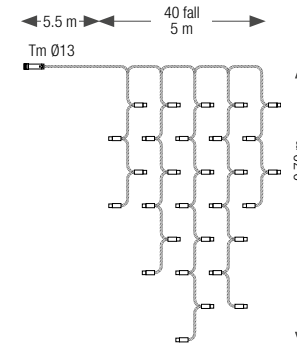

CONTROLLABLE GARLANDS

24V

PLC DC

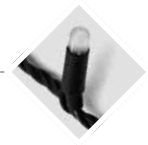

REFERENCE	LENGTH	NB LED	LED	CABLE	P. / 230V
550744	25 m	250			30 W
550745	25 m	250			30 W
550746	25 m	250			25 W
550748	25 m	250			35 W
550749	25 m	250			35 W

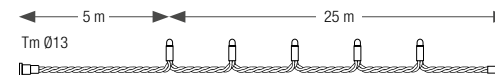

LUMINOUS GARLANDS



The majority of our products are available in both 230V and SELV*.

All our 230V products are rubber-wired to ensure optimal insulation. All our 24V products are wired with durable PVC (except for the 24V Titan range, which is rubber-wired).

All our products feature 100% LED technology.

For all glittering products, one LED in every five shines with a white glitter effect. For Confetti products, each LED gradually and randomly changes color.

* SELV: Safety Extra Low Voltage, lower than 50V.

There are 4 different types of connectors Plug & Light:

- A connectors plug together (230V).
- B connectors plug together (230V).
- C connectors plug together (230V).
- D connectors plug together (24V).

For all our products, the specified dimensions do not include connectors.

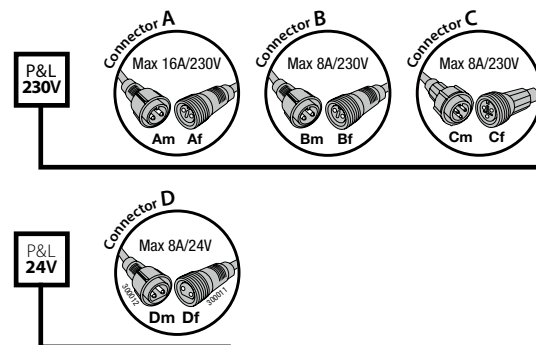

Optima Range

With its IP67 rating, the Optima range is highly reliable.

Built without a rectifier, the Optima range requires less plastic in its manufacture: One ton of plastic is saved in its design.

Optima also uses approximately 20% less energy, saving four tonnes of CO₂.

It requires a non-rectified power cable (ref. 550734 or 550735).



This pictogram makes it easy to identify all the products in the Optima range.

MicroLED range, 3 times brighter.

All our products are made with 100% LED. For all glittering microLED products, every fourth LED is animated. current.

We advise you to connect microLED products **in parallel rather than in series**, to maximize their extendability. By default, it is the serial value that is noted in the tables.

OPTIMA GARLANDS

230V



REFERENCE	LGT.	NB LED	LED	CABLE	P. / 230V	EXTEND
550885	20 m	200	○	≡	13 W	100m max
550886	20 m	200	○	≡	13 W	100m max
550887	20 m	200	●	≡	15 W	100m max
550888	20 m	200	●	≡	13 W	100m max
550889	20 m	200	○	≡	13 W	100m max
550890	20 m	200	○	≡	13 W	100m max
551020*	20 m	200	○	≡	13 W	100m max
550891	20 m	200	●	≡	13 W	100m max
550892	20 m	200	●	≡	13 W	100m max



REFERENCE	LGT.	NB LED	LED	CABLE	P. / 230V	EXTEND
550689	20 m	200	○	≡	13 W	100m max
550690	20 m	200	○	≡	13 W	100m max
550691	20 m	200	○	≡	13 W	100m max
550692	20 m	200	○	≡	13 W	100m max
550693	20 m	200	●	≡	13 W	100m max
550694	20 m	200	●	≡	13 W	100m max
550695	20 m	200	●	≡	15 W	100m max
550696	20 m	200	●	≡	13 W	100m max
550697	20 m	200	●	≡	13 W	100m max
550698	20 m	200	●	≡	13 W	100m max
550699	20 m	200	●	≡	13 W	100m max
550700	20 m	200	●	≡	13 W	100m max

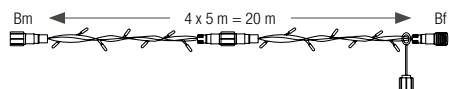

Use a non-rectified power cable, ref. 550734 or 550735.
For ref. 551020, the glittering LEDs are warm white.



Sainte Maxime • France

GARLANDS



Le Mans • France

230V



REFERENCE	LGT.	NB LED	LED	CABLE	P. / 230V	EXTEND
550827	20 m	200			17 W	100m max

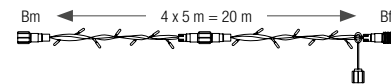

Ref. 550827 is sold in packs of 12 and includes a rectified power cable, ref. 058989BL.



REFERENCE	LGT.	NB LED	LED	CABLE	P. / 230V	EXTEND
550828	20 m	200			17 W	100m max
550829	20 m	200			17 W	100m max

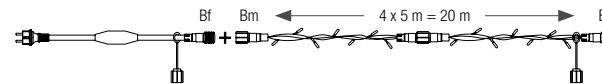

REFERENCE	LGT.	NB LED	LED	CABLE	P. / 230V	EXTEND
059937	20 m	200			17 W	100m max

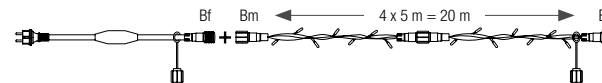

24V



REFERENCE	LGT.	NB LED	LED	CABLE	P. / 24V
051097	20 m	200			9 W - 380 mA
051098	20 m	200			9 W - 380 mA
051099	20 m	200			9 W - 380 mA
051100	20 m	200			6 W - 250 mA
051101	20 m	200			9 W - 380 mA
051103	20 m	200			9 W - 380 mA
550468	20 m	200			11.5 W - 240 mA
550469	20 m	200			11.5 W - 240 mA
551345*	20 m	200			9 W - 380 mA
551344*	20 m	200			9 W - 380 mA
551343*	20 m	200			9 W - 380 mA



REFERENCE	LGT.	NB LED	LED	CABLE	P. / 24V
051105	20 m	200			9.5 W - 395 mA
051106	20 m	200			9.5 W - 355 mA
051107	20 m	200			9.5 W - 395 mA
051108	20 m	200			7.5 W - 310 mA
051109	20 m	200			9.5 W - 395 mA
051111	20 m	200			9.5 W - 395 mA
051112	20 m	200			11 W - 458 mA

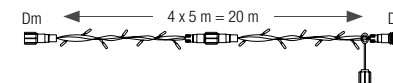

P&L 24V range: requires a power supply and transformer.

Maximum series length: 80m of wire.

SPARKLING GARLANDS

230V



REFERENCE	LGT.	NB LED	LED	CABLE	P. / 230V	EXTEND
550568	20 m	140	○	≡	17 W	100m max
550570	20 m	140	●	≡	17 W	100m max
550569	20 m	140	○	≡	17 W	100m max
550656	20 m	140	●	≡	17 W	100m max

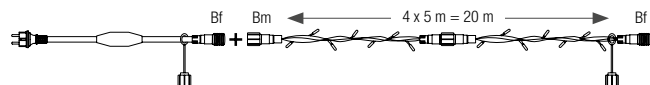

24V

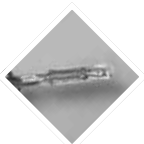

REFERENCE	LGT.	NB LED	LED	CABLE	P. / 24V
550556	20 m	140	○	≡	7.2 W - 300 mA
550557	20 m	140	●	≡	7.2 W - 300 mA

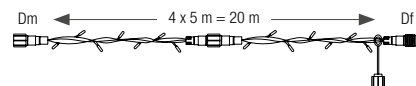

All LED garland sparkle.

P&L 24V range: requires a power supply and transformer. Maximum series length: 80m of wire.

CLASSIC'LINE GARLANDS

230V

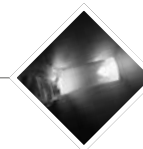

REFERENCE	LGT.	NB LED	LED	CABLE	P. / 230V	EXTEND
051260	20 m	200	○	≡	16 W	100m max
550008	20 m	200	●	≡	16 W	100m max
550009	20 m	200	●	≡	16 W	100m max
550011	20 m	200	○	≡	16 W	100m max
550016	20 m	200	●	≡	16 W	100m max



550011

High-brightness SMD LED.

P&L 24V range: requires a power supply and transformer. Maximum series length: 80m of wire.

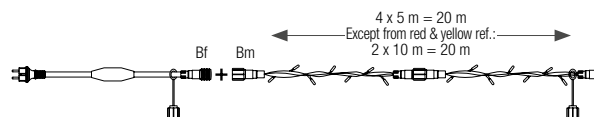

Beverly Hills • U.S.A.

CANOA GARLANDS

230V



REFERENCE	LENGTH	NB LED	LED	CABLE	P. / 230V	EXTEND
550643	20 m	136	○	—	13.5 W	100m max
550644	20 m	136	●	—	13.5 W	100m max

The perfect garland to cover tree branches.

Preprogrammed crackling effect (1/5 LED).

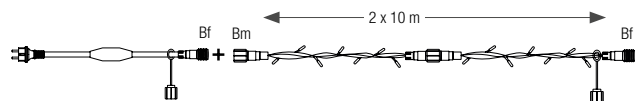

Park Ridge • U.S.A.

FLAME EFFECT GARLAND

24V

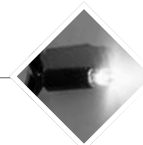

REFERENCE	LENGTH	NB LED	LED	CABLE	P. / 24V
550565	20 m	200	●	—	4.8 W - 200 mA

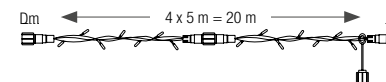

Flame effect.

One in every two LEDs twinkles like a candle to create the effect.
Requires a power supply and transformer. Maximum series length: 80m of wire.



TITAN GARLANDS

24V



REFERENCE	LGT.	NB LED	LED	CABLE	P. / 24V
550213	10 m	100	○	—	5.5 W - 229 mA
550214	10 m	100	●	—	5.5 W - 229 mA



REFERENCE	LGT.	NB LED	LED	CABLE	P. / 24V
550211	10 m	100	○	—	5.5 W - 229 mA
550212	10 m	100	●	—	5.5 W - 229 mA
550334	10 m	100	●	—	5.5 W - 229 mA

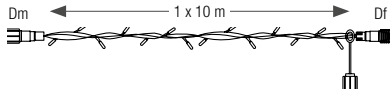

Light strings in black rubber cable, to decorate trees safely.

Preprogrammed glittering effect (1/5 LED).

P&L 24V range: requires a power supply and transformer. Maximum series length: 80m of wire.



Carros • France

CONFETTI GARLANDS

230V



REFERENCE	LENGTH	NB LED	LED	CABLE	P. / 230V	EXTEND
051095	20 m	160			4 W / 230V	100m max

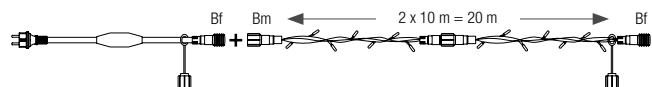

24V

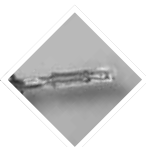

REFERENCE	LENGTH	NB LED	LED	CABLE	P. / 24V
550558	20 m	168			4.1 W - 170 mA

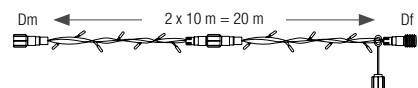

New pastel hues

Each LED is gradually and randomly colourchanging.

P&L 24V range: requires a power supply and transformer. Maximum wire length in series: 80m



WATERCOLOUR GARLANDS

230V

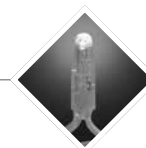

REFERENCE	LENGTH	NB LED	LED	CABLE	P. / 230V	EXTEND
550315	20 m	200			12 W	100m max
550316	20 m	200			17 W	100m max
550317	20 m	200			12 W	100m max

Garlands in soft pastel colors.



REMOTE-CONTROLLED RGB GARLANDS & ROPE LIGHTS

Change the color or animation as you wish with a simple remote control.

Choose your color and pre-programmed animation: glittering, steady, or automatic color change.

A controller is required before installation to control the garland or rope lights. One remote control can manage all the decorations up to 10 meters.



Consult us for the implementation of your projects.



230V



REFERENCE	DESCRIPTION	LGT.	NB LED	LED	CABLE	P. / 230V	EXTEND
550222	RGB garland	10 m	100			37 W	3 000 LED

230V CONTROLLER

REFERENCE	DESCRIPTION	CABLE
032376	230V power cable	
550220	230V controller	

Example of 230V cabling plan:

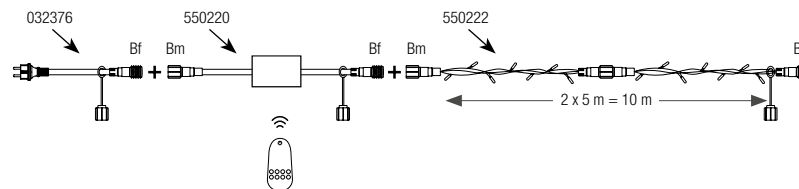

230V Range : requires an unrectified power supply and a controller. Compatible with Plug & Light accessories.

REMOTE CONTROL

REFERENCE	DESCRIPTION
550575	Remote control

REMOTE-CONTROLLED RGB GARLANDS & ROPE LIGHTS

36V

DC

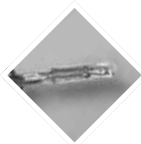

REFERENCE	DESCRIPTION	LGT.	NB LED	LED	CABLE	EXTEND
550240	RGB garland	10 m	100			350 LED
550241	RGB rope light	30 m	36 LED /m		-	350 LED

36V CONTROLLER

REFERENCE	DESCRIPTION	CABLE
032371	Bipolar power cable + earth	
550239	36V controller	
550242	36V transformer 150W	

ACCESSORIES BEYOND 36V TRANSFORMER

REFERENCE	DESCRIPTION	LGT.	CABLE
032367	T-connector	25 cm	
032366	Extend power cable	1 m	
550244	Extend power cable	2 m	
032368	Connector 6 falls	1 m	
032365	Connection rope light to garland	30 cm	
032364	Connection garland to rope light	30 cm	



REMOTE CONTROL

REFERENCE	DESCRIPTION
550575	Remote control

Example of 36V cabling plan:

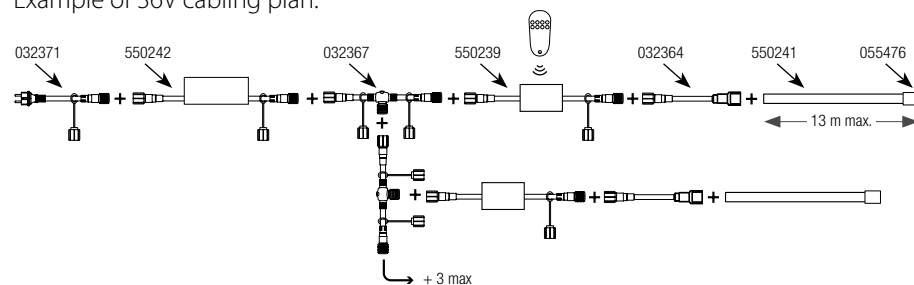

36V range : requires a power supply cable, a transformer and a controller. Rope light is cuttable every 0.27 m.

MICROLED GARLANDS

MICROLED VOLUME GARLANDS

24V



REFERENCE	LGT.	NB LED	LED	CABLE	P. / 24V	EXTEND
550811	10 m	100	○	▬	5.5 W - 227 mA	1+3



REFERENCE	LGT.	NB LED	LED	CABLE	P. / 24V	EXTEND
550810	10 m	100	○	▬	5.5 W - 227 mA	1+3

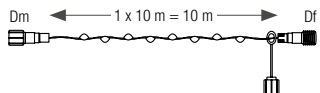

See accessories on p. 263.

Reinforced cable. Pre-programmed glittering effect (1/4 LED). Ideal for indoor or outdoor use. Ivory white LED. Requires a power cable and a 24V transformer. Max length in series: 40m of wire



230V/12V

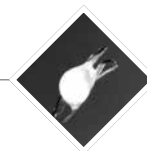

REFERENCE	LGT.	NB LED	LED	CABLE	P. / 230V
550993*	6 m	240	○	▬	18 W



REFERENCE	LGT.	NB LED	LED	CABLE	P. / 230V
550266	6 m	240	○	▬	17 W
550267	6 m	240	○	▬	17 W
550268	6 m	240	●	▬	17 W

230V/6V



REFERENCE	LGT.	NB LED	LED	CABLE	P. / 230V
550263	3 m	120	○	▬	4 W
550264	3 m	120	○	▬	4 W
550265	3 m	120	●	▬	5 W

MicroLED 3 times brighter

Suitable for indoor and outdoor use. 40 LED /m, power supply included.

Ref. 550264 & 550267: ivory white LED. Coloured packaging.

Not compatible with 24V P&L.

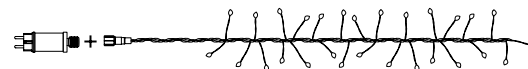

CHRISTMAS TREE GARLANDS

230V



REFERENCE	LGT.	NB LED	LED	CABLE	P. / 230V	EXTEND
551342*	2.70 m	200	●	—	15 W	100m max

24V

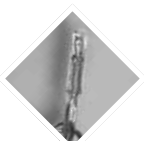

REFERENCE	LGT.	NB LED	LED	CABLE	P. / 24V	EXTEND
550989	2.70 m	200	●	—	7 W - 291 mA	80m max
551350*	2.70 m	200	●	—	7 W - 291 mA	80m max

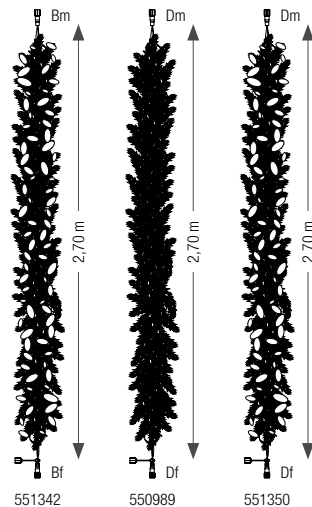

Traditional and natural effect.

Ref.551342 and 551350: gold glitter trim.

P&L 230V range: requires a rectified or non-rectified power supply.
 P&L 24V range: requires a power supply and transformer. Maximum of 8 products per series.



RIBBON LIGHTS FOR POLE

24V



REFERENCE	LGT.	WIDTH	NB LED	LED	MAT	P. / 24V
550170	4 m	20 cm	104	●	—	4.7 W - 195 mA
550171	4 m	20 cm	104	●	—	4.7 W - 195 mA
550548	4 m	20 cm	104	○	—	3.8 W - 158 mA

Pole decoration, quick and easy to set up.

Pre-programmed glittering effect (1 in every 5 LEDs). Green or silver PVC mat. Suitable for indoor and outdoor use. Requires a power supply and transformer.

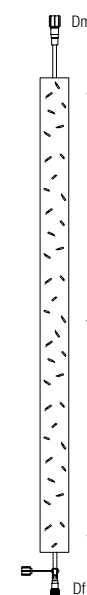

LUMINOUS BOAS



OPTIMA BOAS

230V



REFERENCE	LENGTH	NB LED	LED	CABLE	P. / 230V	EXTEND
551264*	1 m	100	○	□	7 W	1+47
551259*	1 m	100	●	□	7 W	1+47
551251*	6 m	600	○	□	35 W	1+7
551249*	6 m	600	●	□	37 W	1+7
551266*	1 m	100	○	■	7 W	1+47
551263*	1 m	100	●	■	7 W	1+47
551267*	6 m	600	○	■	35 W	1+7
551262*	6 m	600	●	■	35 W	1+7

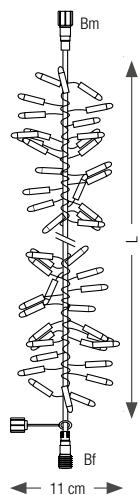

Volume effect.

With self-supporting steel cable.
Preprogrammed glittering effect (1/5 LED).
Requires a non-rectified power cable.
(ref.550734 or 550735).



Czech Republic

BOAS

230V

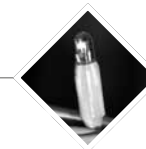

REFERENCE	LENGTH	NB LED	LED	CABLE	P. / 230V	EXTEND
059914	1 m	100	○	□	7 W	1+47
550651	1 m	100	○	■	7 W	1+47
550653	6 m	600	○	■	42 W	1+7



REFERENCE	LENGTH	NB LED	LED	CABLE	P. / 230V	EXTEND
550925	1 m	100	○	■	10 W	1+47
550926	1 m	100	●	■	10 W	1+47

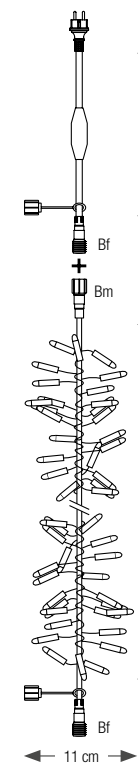

Volume effect.

With self-supporting steel cable.
Preprogrammed glittering effect (1/5 LED).
Crackling: All the boa's LED crackle.



Dunkerque • France



Watch the animation

FIREWORK BOAS

230V



REFERENCE	LENGTH	NB LED	LED	CABLE	P. / 230V
551160	1.20 m	120	○	—	21 W
551161	3 m	144	○	—	26 W
550078	1.20 m	120	○	—	21 W
550079	3 m	144	○	—	26 W
550081	5 m	240	○	—	42 W

Burning wick effect animation.

Requires a non-rectified power supply.
For horizontal use, a steel cable is required.
Non-extendable product.



Watch the animation

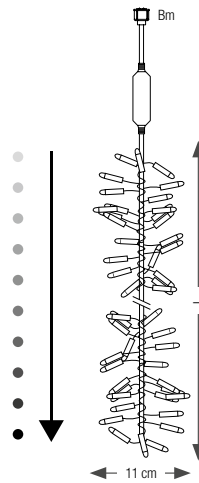

MICROLED BOAS

24V

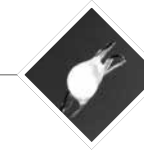
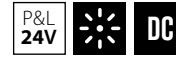

REFERENCE	LGT.	NB LED	LED CABLE	P. / 24V
550217	20 m	1600	○	12 W - 1000 mA



REFERENCE	LGT.	NB LED	LED CABLE	P. / 24V
550218	20 m	1600	○	12 W - 1000 mA

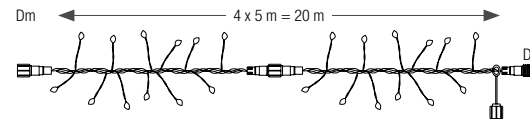

MicroLED, 3 times brighter.

Pre-programmed glittering effect (1 in every 4 LEDs).
Suitable for indoor and outdoor use. Ivory white LED.
Requires a power cable and 24V transformer. Not extendable in series.



Bordeaux • France



LIGHT NETS
& CURTAIN LIGHTS



OPTIMA LIGHT NETS

230V



REFERENCE	DIMENSIONS	NB LED	LED	CABLE	P. / 230V	EXTEND
551311*	H 3 x W 2 m	384	○	▭	24 W	1+13
551313*	H 3 x W 2 m	384	●	▭	24 W	1+13
551312*	H 3 x W 2 m	384	○	▬	24 W	1+13
551314*	H 3 x W 2 m	384	●	▬	24 W	1+13

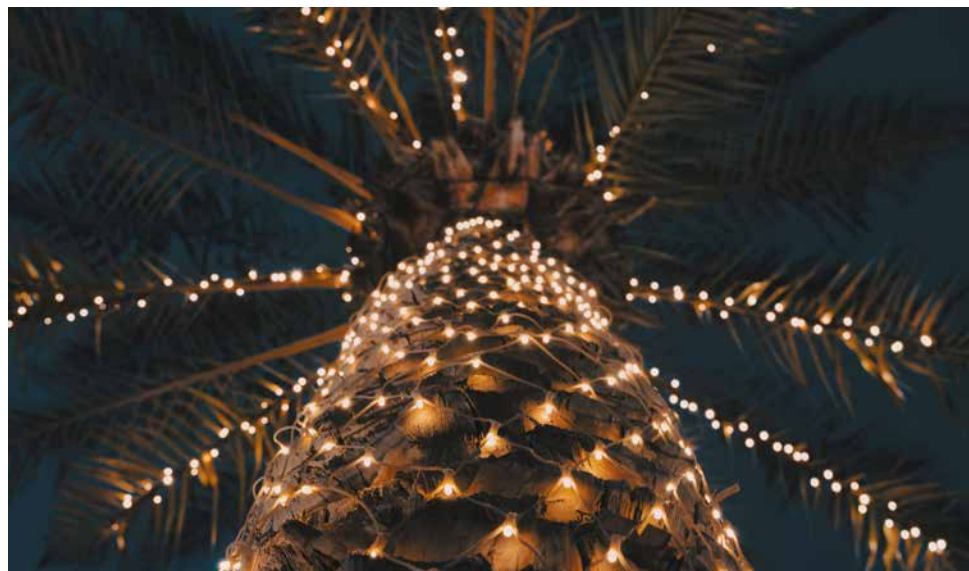
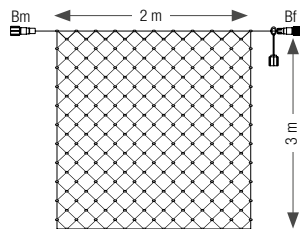

551313

Drape your light net over your outdoor and indoor spaces: trees, bushes, trunks, columns, cabins... as well as in windows, on awnings, decorations, etc.

Pre-programmed random glittering effect (1 in every 5 LEDs).
Nets are expandable in width. Very low energy consumption.
Requires a non-rectified power cable, ref. 550734 or 550735.

OPTIMA CURTAIN LIGHTS

230V



REFERENCE	DIMENSIONS	NB LED	LED	CABLE P. / 230V	EXTEND
550851	H 1.5 x W 2 m	360	○	17 W	1+39
550852	H 1.5 x W 2 m	360	●	20 W	1+39
550853	H 1.5 x W 2 m	360	●	22 W	1+39
550854	H 1.5 x W 2 m	360	●	20 W	1+39
550855	H 3 x W 2 m	540	○	19 W	1+24
550856	H 3 x W 2 m	540	●	25 W	1+24
550857	H 3 x W 2 m	540	●	35 W	1+24
550858	H 3 x W 2 m	540	●	25 W	1+24
550860	H 5 x W 2 m	900	○	50 W	1+12
550861	H 5 x W 2 m	900	●	50 W	1+12
550862	H 5 x W 2 m	900	●	67 W	1+9
550863	H 5 x W 2 m	900	●	50 W	1+12
550864	H 7 x W 2 m	1260	○	50 W	1+12
550865	H 7 x W 2 m	1260	●	50 W	1+12
550866	H 7 x W 2 m	1260	●	67 W	1+12
550867	H 7 x W 2 m	1260	●	50 W	1+12
550868	H 10 x W 2 m	1800	○	103 W	1+5
550869	H 10 x W 2 m	1800	●	101 W	1+5
550870	H 10 x W 2 m	1800	●	101 W	1+5
550871	H 10 x W 2 m	1800	●	101 W	1+5

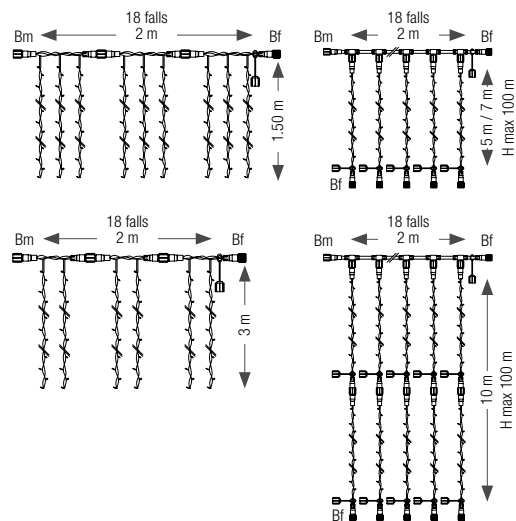

Reims • France

Requires a non-rectified power cable
ref.550734 or 550735.

230V



REFERENCE	DIMENSIONS	NB LED	LED	CABLE P. / 230V	EXTEND
550668	H 1.5 x W 2 m	150	○	11 W	1+27
550669	H 1.5 x W 2 m	150	●	11 W	1+27
550670	H 1.5 x W 2 m	150	●	11 W	1+27
550671	H 1.5 x W 2 m	150	●	11 W	1+27
550672	H 3 x W 2 m	280	○	23 W	1+15
550673	H 3 x W 2 m	280	●	19 W	1+15
550674	H 3 x W 2 m	280	●	23 W	1+15
550675	H 3 x W 2 m	280	●	23 W	1+15
550676	H 5 x W 2 m	442	○	43 W	1+8
550677	H 5 x W 2 m	442	●	43 W	1+8
550678	H 5 x W 2 m	442	●	43 W	1+8
550679	H 5 x W 2 m	442	●	43 W	1+8
550680	H 7 x W 2 m	598	○	36 W	1+6
550681	H 7 x W 2 m	598	●	36 W	1+6
550682	H 7 x W 2 m	598	●	46 W	1+6
550683	H 7 x W 2 m	598	●	46 W	1+6
550684	H 10 x W 2 m	858	○	46 W	1+5
550685	H 10 x W 2 m	858	●	36 W	1+5

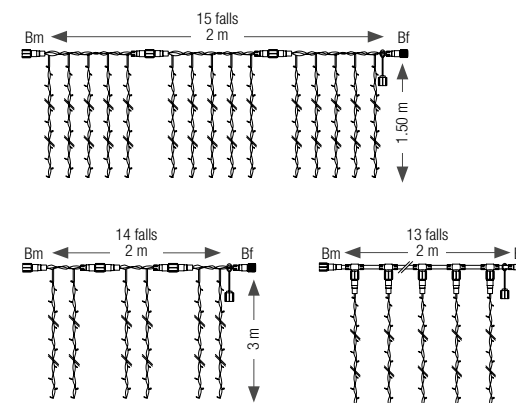

CURTAIN LIGHTS

230V



REFERENCE	DIMENSIONS	NB LED	LED	CABLE	P./ 230V	LARG. MAX
050097	H 1.5 x W 2 m	360	○	≡	29 W	1+11
050098	H 1.5 x W 2 m	360	○	≡	29 W	1+11
550831	H 1.5 x W 2 m	360	●	≡	29 W	1+11
550832	H 3 x W 2 m	540	●	≡	44 W	1+7
550833	H 5 x W 2 m	900	●	≡	72 W	1+4
550835	H 10 x W 2 m	1800	●	≡	144 W	1+1

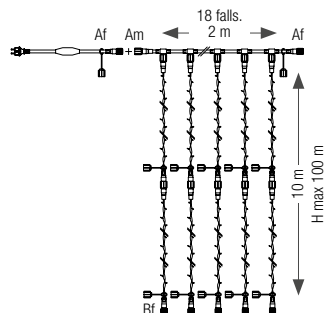
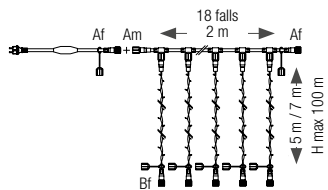
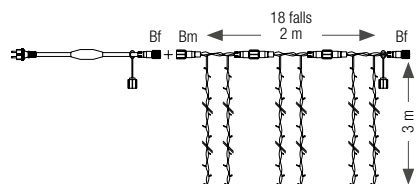
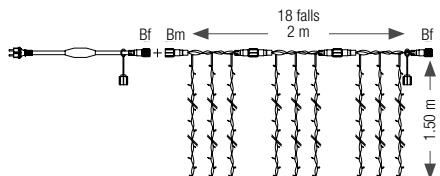

230V



REFERENCE	DIMENSIONS	NB LED	LED	CABLE	P./ 230V	EXTEND
550042	H 3 x W 2 m	280	●	≡	28 W	1+15
550046	H 5 x W 2 m	442	●	≡	40 W	1+6
550045	H 5 x W 2 m	442	●	≡	40 W	1+6
550047	H 7 x W 2 m	598	○	≡	50 W	1+6

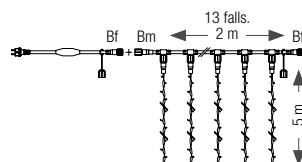
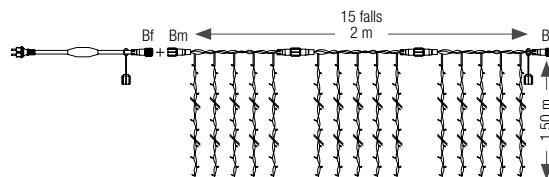

Curtain lights : Ideal for facades & across street.

Preprogrammed glittering effect (1/5 LED).
Extendable curtain lights.
Height max. 100 m for height-extendable curtains.

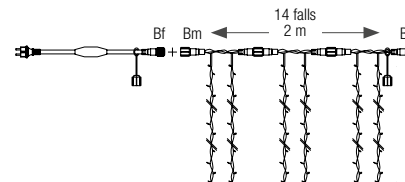

Colchester • United Kingdom

CURTAIN LIGHTS

24V

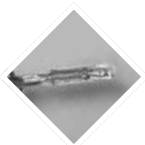

REFERENCE	HGT.	WIDHT	NB LED	LED	CABLE	P. / 24V	EXTED.
550063	2 m	2 m	240	○	≡	16.5 W - 687.5 mA	1+2
550064	2 m	2 m	240	●	≡	16.5 W - 687.5 mA	1+2
550065	3 m	2 m	360	○	≡	32 W - 1333 mA	1+1
550066	3 m	2 m	360	●	≡	32 W - 1333 mA	1+1
550067	5 m	2 m	360	○	≡	32 W - 1333 mA	1+1
550068	5 m	2 m	360	●	≡	32 W - 1333 mA	1+1

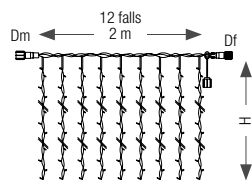

Extendable 24V range: find all accessories on p.271.

Preprogrammed glittering effect (1/5 LED).
Extendable in width. Translucent cable for further
discretion. Encapsulated LED. Compatible with
our 24V transformers.

SPARKLING CURTAINS

230V



REFERENCE	DIMENSIONS	NB LED	LED	CABLE	P. / 230V	EXTEND.
550923	H 5 x W 2 m	900	○	≡	75 W	1+3
550924	H 5 x W 2 m	900	●	≡	75 W	1+3

All the LED curtain lights sparkle.
Requires a rectified power supply.



Watch the animation

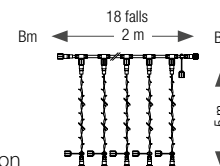

Carros • France



COMET CURTAINS

230V



REFERENCE	DIMENSIONS	NB LED	LED	CABLE	P. / 230V	EXTEND
550921	H 5 x W 1 m	400	○	≡	75 W	1+8
550922	H 5 x W 1 m	400	○	≡	75 W	1+8

Chasing and sparkling effects.

Expandable in width. Requires a non-rectified power cable.

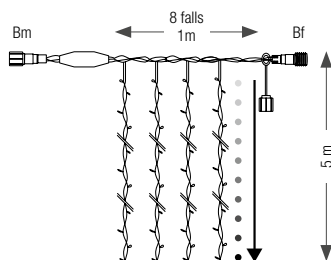

Watch the animation



BOA MICROLED CURTAINS

24V

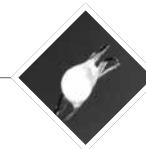

REFERENCE	DIMENSIONS	NB LED	LED	CABLE	P. / 24V	EXTEND
550522	H 0.50 x W 6 m 800	○	≡		19.6 W - 817 mA	1+2

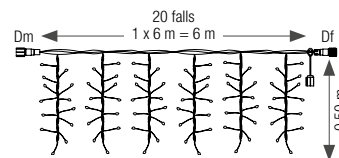

MicroLED 3 times brighter.

Find all accessories on p.271.

Pre-programmed glittering effect (1/4 LED). Ideal for indoor or outdoor use. Ivory white LED. Requires a power cable and a 24V transformer. Reinforced cable. Max length in series: 40m of wire.



CEILING LIGHTS



CEILING LIGHTS

230V



REFERENCE	DIMENSIONS	NB LED	LED	CABLE	P. / 230V	MAX. WIDTH
551265*	H 30 x W 2 m	480	○	≡	24 W	1+9
551250	H 30 x W 2 m	480	●	≡	24 W	1+9



REFERENCE	DIMENSIONS	NB LED	LED	CABLE	P. / 230V	MAX. WIDTH
551252	H 30 x W 2 m	480	○	≡	28 W	1+9
551268*	H 30 x W 2 m	480	●	≡	28 W	1+9



Dreux • France

Starry sky effect to your streets or town square.

Preprogrammed glittering effect (1/5 LED), and staggered lights any 25 cm intervals (i.e. total interval of 50 cm on the same drop). Height max. 90 m. Requires a non-rectified power cable, ref. 550734 or 550735.

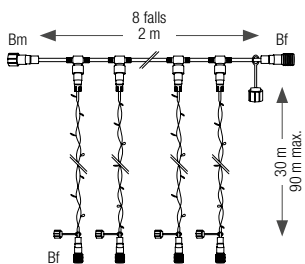

230V



REFERENCE	DIMENSIONS	NB LED	LED	CABLE	P. / 230V	MAX. WIDTH
551348*	H 30 x W 2 m	800	○	≡	55 W	1+11
551349*	H 30 x W 2 m	800	●	≡	55 W	1+11



REFERENCE	DIMENSIONS	NB LED	LED	CABLE	P. / 230V	MAX. WIDTH
551346*	H 30 x W 2 m	800	○	≡	55 W	1+11
551347*	H 30 x W 2 m	800	●	≡	55 W	1+11



Designed for quick and easy installation, these light ceilings are wired with one sling for each downlight.

Pre-programmed glittering effect (1 in every 5 LEDs), with staggered light points every 6 cm (total spacing of 12 cm on the same drop). Maximum height: 90m. Requires a non-rectified power cable, ref. 550734 or 550735.

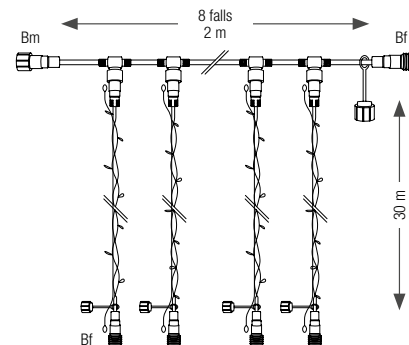

CEILING LIGHTS

230V



REFERENCE	DIMENSIONS	NB LED	LED	CABLE	P. / 230V	LARG. MAX.
050526	H 30 x W 2 m	480			32 W	1+7

Starry sky effect for your streets or town square.

Pre-programmed glittering effect (1 in every 5 LEDs), with staggered lights at 25 cm intervals (i.e., a total spacing of 50 cm on the same drop). Maximum height: 100m.

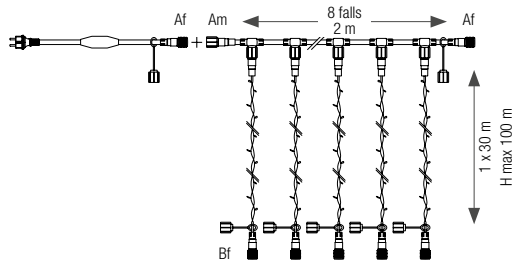

24V

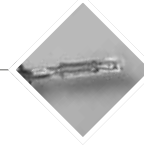

REFERENCE	DIMENSIONS	NB LED	LED	CABLE	P. / 24V	MAX. WIDTH
551308*	H 30 x W 2 m	700			32 W - 130 mA	1+1
551309*	H 30 x W 2 m	700			32 W - 130 mA	1+1



REFERENCE	DIMENSIONS	NB LED	LED	CABLE	P. / 24V	MAX. WIDTH
551307*	H 30 x W 2 m	700			32 W - 130 mA	1+1
551306*	H 30 x W 2 m	700			32 W - 130 mA	1+1

Quick installation thanks to the pre-wired slings on each drop.

Staggered light points every 30 cm (total spacing of 60 cm on the same drop). Expandable in width.

Extendable 24V range: find all accessories on p.271.

Pre-programmed glittering effect (1 in every 5 LEDs). Expandable in width. Translucent cable for greater discretion. Requires a power supply and transformer.

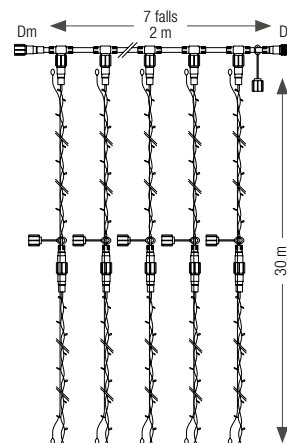

Narbonne • France

CHROMEX

ICICLE LIGHTS



OPTIMA ICICLE LIGHTS

SPARKLING ICICLE LIGHTS

230V



REFERENCE	DIMENSIONS	NB LED	LED	CABLE	P. / 230V	EXTEND
550872	H 0.50 x W 4 m	150	○	▬	6 W	100m max
550873	H 0.50 x W 4 m	150	●	▬	6 W	100m max
550874	H 0.50 x W 4 m	150	●	▬	4 W	100m max
550875	H 0.50 x W 4 m	150	●	▬	6 W	100m max
550876	H 0.80 x W 4 m	200	○	▬	9 W	100m max
550877	H 0.80 x W 4 m	200	●	▬	13 W	100m max
550878	H 0.80 x W 4 m	200	●	▬	9 W	100m max
550879	H 0.80 x W 4 m	200	●	▬	13 W	100m max
550880	H 0.80 x W 4 m	200	●	▬	13 W	100m max
550881	H 1.50 x W 4 m	300	○	▬	13 W	100m max
550882	H 1.50 x W 4 m	300	●	▬	16 W	100m max
550883	H 1.50 x W 4 m	300	●	▬	13 W	100m max
550884	H 1.50 x W 4 m	300	●	▬	13 W	100m max



REFERENCE	DIMENSIONS	NB LED	LED	CABLE	P. / 230V	EXTEND
550686	H 0.80 x W 4 m	200	○	▬	12 W	100m max
550687	H 0.80 x W 4 m	200	●	▬	13 W	100m max
550688	H 0.80 x W 4 m	200	●	▬	12 W	100m max

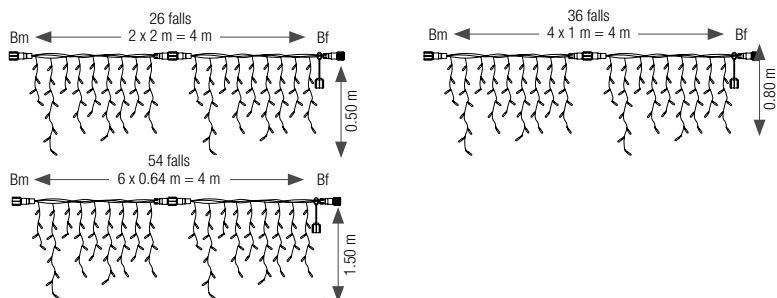

Requires a non-rectified power cable
ref.550734 or 550735.

230V



REFERENCE	DIMENSIONS	NB LED	LED	CABLE	P. / 230V	EXTEND
551172	H 0.80 x W 3.75 m	132	○	▬	50 W	1+9

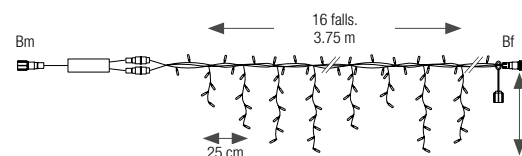

Chasing and sparkling effects.

Sparkling effect on the collector cable, chasing effect on the drops. Requires a non-rectified power supply. Expandable in width.



Watch the animation



Quimper • France

ICICLE LIGHTS

230V



REFERENCE	DIMENSIONS	NB LED	LED	CABLE	P. / 230V	EXTEND
550824	H 0.50 x W 4 m	159			12 W	1+28
059927	H 0.80 x W 4 m	200			17 W	1+19
550825	H 0.80 x W 4 m	200			17 W	1+19
550826	H 1.50 x W 4 m	300			26 W	1+12
050540	H 1.50 x W 4 m	300			26 W	1+12



REFERENCE	DIMENSIONS	NB LED	LED	CABLE	P. / 230V	EXTEND
059237	H 0.80 x W 4 m	200			19 W	1+18

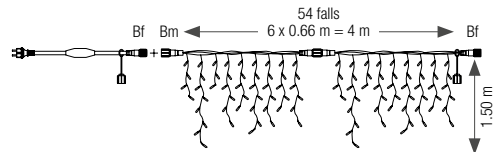
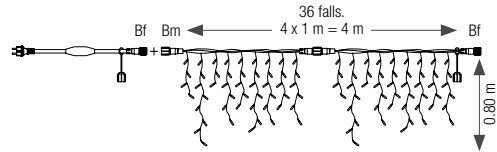
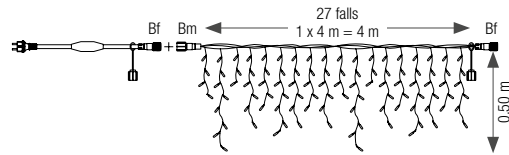

24V

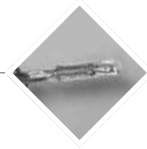

REFERENCE	DIMENSIONS	NB LED	LED	CABLE	P. / 24V
550914	H 0.50 x W 4 m	174			8.2 W - 196 mA
550915	H 0.50 x W 4 m	174			8.2 W - 196 mA

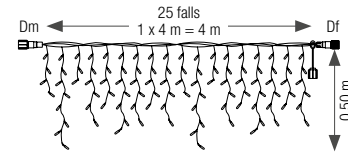

Extendable 24V range: find all accessories on p.271.

Preprogrammed glittering effect (1/5 LED). Width can be extended. Translucent cable for further discretion. Encapsulated LED. Requires a power supply and transformer.



Fos sur Mer • France

LUMINOUS SUSPENSIONS



SHINE SUSPENSIONS

24V



REFERENCE	DIAMETER	NB LED	LED	CABLE	P. / 24V
551316*	30 cm	100	○	≡	4 W - 16 mA
551315*	30 cm	100	●	≡	4 W - 16 mA

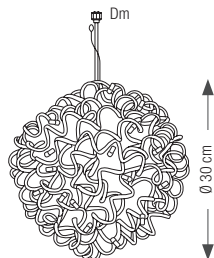

Ideal for hanging on trees.

Gold or silver aluminum ball.
Supplied with sling and fastening ring.
Requires a power supply and transformer.



551316



551315

BEADED BALL SUSPENSIONS

24V



REFERENCE	DIAMETER	NB LED	LED	GLOBE	CABLE	P. / 24V
551329*	15 cm	12	○	○	≡	1 W - 36 mA
551330*	25 cm	12	○	○	≡	1 W - 36 mA
551327*	15 cm	12	●	○	≡	1 W - 36 mA
551328*	25 cm	12	●	○	≡	1 W - 36 mA
551331*	15 cm	12	●	●	≡	1 W - 36 mA
551332*	25 cm	12	●	●	≡	1 W - 36 mA
551333*	15 cm	12	●	●	≡	1 W - 36 mA
551334*	25 cm	12	●	●	≡	1 W - 36 mA

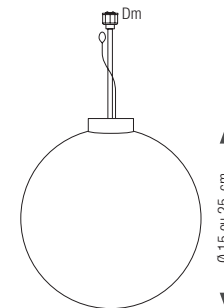

Perfect on trees, by day or night.

Lightweight, colorful soft ball with glitter effect.
Supplied with sling and fastening ring.
Requires a power supply and transformer.



551330



551332

LIGHTING BULBS SUSPENSIONS

230V



REFERENCE	DIAMETER	LED	CABLE	P. / 230V
050754	29 cm	○	—	5 W
050757	40 cm	○	—	5 W
411966	29 cm	○	—	5 W

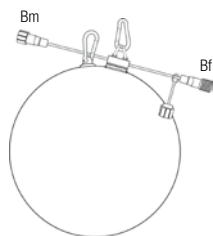

050754

Intense brightness.

Pearly effects during the day/ light bulbs at night.

Supplied with alpine karabiners.

Requires an unrectified power supply.



Belgium

BELLIZ SUSPENSIONS

230V



REFERENCE	DIAMETER	NB LED	LED	CABLE	P. / 230V
551182	40 cm	296	○	—	16 W
551183	40 cm	296	○	—	16 W

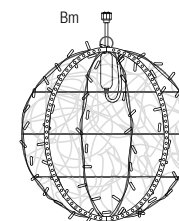

← 0 40 cm →

Snowfall effect.

Frosted lace covering. Suitable for outdoor use or inside buildings not ruled by ERP. Provide a non-rectified power supply. Delivered without sling (ref.051039).



Watch the animation



551182



551183

Cadoive • France

MICROLED GLOBES SUSPENSIONS

24V

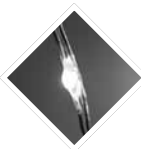

REFERENCE	DIMENSIONS	NB LED	LED	CABLE	P. / 24V
550523	∅ 20 cm	80	○	≡	2.8 W - 113 mA
550524	∅ 30 cm	100	○	≡	3.2 W - 130 mA
550525	∅ 40 cm	200	○	≡	5.4 W - 220 mA

MicroLED, 3 times brighter.

Supplied without sling, with fastening ring.
 Requires a power supply and transformer.
 Maximum distance between the first and the last product: 80m of wire.

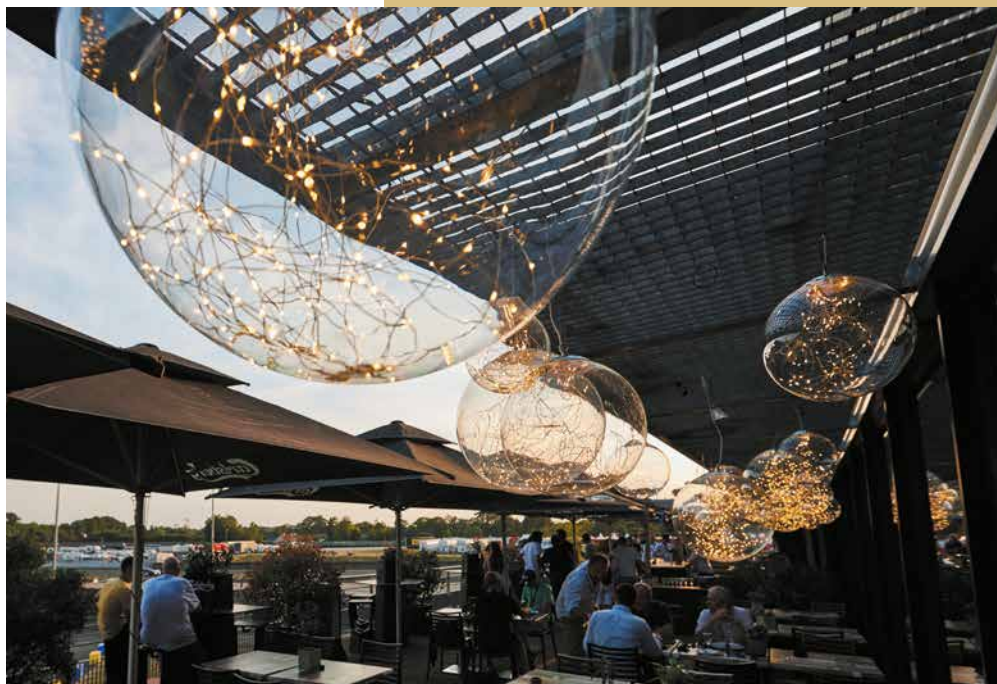
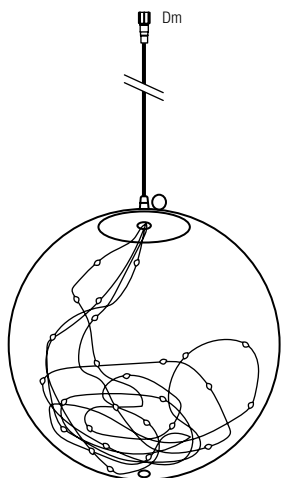

ACCESSORIES

REFERENCE	DESCRIPTION	COMPOSITION
050768	Sling 1 m	Maximum load 15 kg - Indoor only
050769	Sling 3 m	Maximum load 15 kg - Indoor only
051039	Sling 2 m	Maximum load 90 kg - Outdoor



GAÏA, THE FOLDABLE MICROLED SPHERE

24V

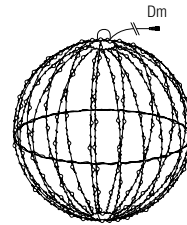
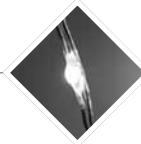

REFERENCE	DESCRIPTION	DIMENSIONS	NB LED	LED	CABLE	P. / 24V
550528	Gaïa Suspension	Ø 30 cm	180	○	≡	5.8 W - 240 mA
550529	Gaïa Suspension	Ø 60 cm	400	○	≡	12.5 W - 510 mA
550526	Gaïa Suspension	Ø 30 cm	180	○	≡	5.8 W - 240 mA
550527	Gaïa Suspension	Ø 60 cm	400	○	≡	12.5 W - 510 mA

MicroLED, 3 times brighter.

Ideal for indoor or outdoor use.

Foldable aluminium structure.

Strengthened cable.

Compatible with our 24V transformers.

Maximum distance between the first and the last product: 80m of wire.



FLOKO SUSPENSIONS

230V



REFERENCE	DIMENSIONS	NB LED	LED	CABLE	P. / 230V
550077	55 x 37 cm	2 x 48	○	≡	9 W

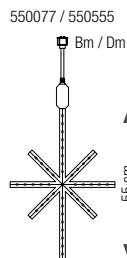

Watch the animation

24V



REFERENCE	DIMENSIONS	NB LED	LED	CABLE	P. / 24V
550555	55 x 37 cm	2 x 48	○	≡	9.6 W - 400 mA

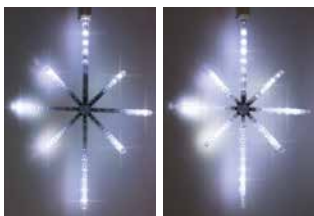

550077

Perfect in a small street with icicle lights,

Animated: Blast of light.

P&L 230V range: Provide a non-rectified power supply. P&L 24V range: Provide power supply and transformer.



Lorient • France

SHOOTING STAR SUSPENSIONS

24V



REFERENCE	DIMENSIONS	NB LED	LED	CABLE	P. / 24V
551340*	37 x 37 cm	216	○	≡	5 W - 210 mA
551341*	37 x 37 cm	216	●	≡	5 W - 210 mA

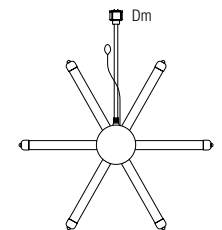

Ideal for trees or across streets.

Animated: Blast of light.

Lighting decorations to hang. Milky effect. Fastening ring on each branch. Supplied with sling. Requires an unrectified power supply.

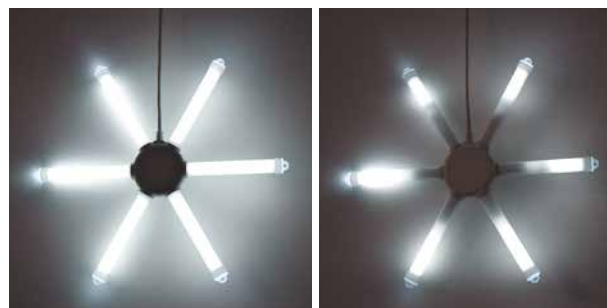

551340



Watch the animation

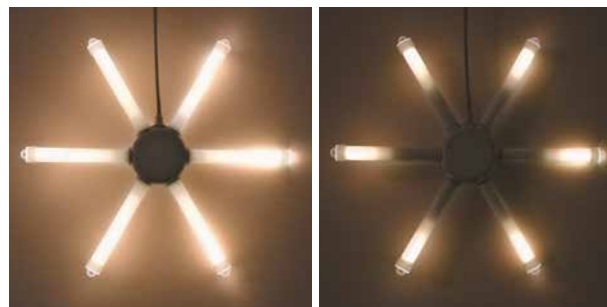

551341



Watch the animation

STELLY STARS SUSPENSIONS

230V



REFERENCE	HGT.	NB LED	LED	CABLE	P. / 230V
050791	50 cm	110	○	≡	8 W
050792	50 cm	110	●	≡	8 W
550233	50 cm	110	●	≡	8 W

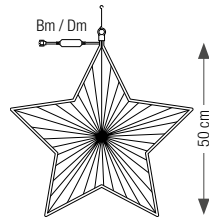

24V



REFERENCE	HGT.	NB LED	LED	CABLE	P. / 24V
550552	50 cm	120	○	≡	7.2 W - 300 mA
550553	50 cm	120	●	≡	7.2 W - 300 mA

Radiant animation to liven up trees and town gateway.

Product mainly designed for outdoor use : PVC anti-UV treated, stainless steel screws. Fastening point included. P&L 230V range : Requires an unrectified power supply. P&L 24V Range : Requires a power supply and transformer. UV-resistant PVC.



550233

050791



Watch the animation



STELLIZ GARLANDS

230V



REFERENCE	LGT	NB LED	LED	CABLE	P. / 230V
050793	3 m	180	○	≡	11 W
050795	3 m	180	●	≡	11 W

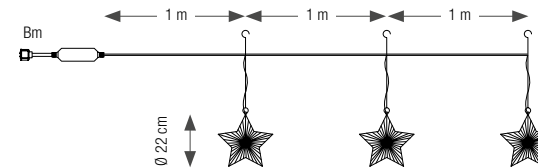

Radiant animation.

One hook per star.



Watch the animation



Velaux • France

3D STAR SUSPENSION

24V



REFERENCE	DIMENSIONS	NB LED	LED	STRUCTURE	P. / 24V
551166	50 x 55 x 10 cm	240			10 W - 420 mA

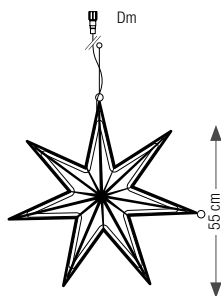

Perfect in suspension or in trees.

3D decoration to suspend. Gold lacquered aluminum frame. Fastening ring included. Requires a power cable and a transformer.



ANGEL HAIR SUSPENSIONS

230V



REFERENCE	LENGHT	NB LED	LED	CABLE	P. / 230V
050602	1 m	150			25 W
050603	1 m	150			25 W

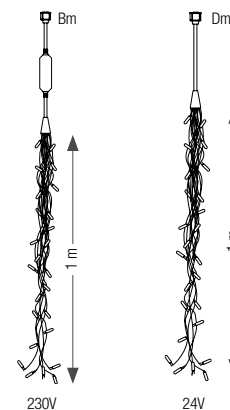
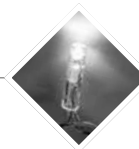

24V



REFERENCE	LENGHT	NB LED	LED	CABLE	P. / 24V
550561	1 m	150			9.6 W - 400 mA
550562	1 m	150			9.6 W - 400 mA



REFERENCE	LENGHT	NB LED	LED	CABLE	P. / 24V
550563	1 m	150			14.4 W - 600 mA

Perfect in suspension or trees.

Extendable 230V range: Requires a power supply. Work on 120V to 230V.

Extendable 24V range: Requires a power cable and a transformer.



LUMINOUS BOUQUETS SUSPENSIONS

230V



REFERENCE	DIAMETER	NB LED	LED	CABLE	P. / 230V
050763	50 cm	100	○	▬	7 W
050764	50 cm	100	○	▬	7 W



REFERENCE	DIAMETER	NB LED	LED	CABLE	P. / 230V
051187	50 cm	100	●	▬	5 W

24V

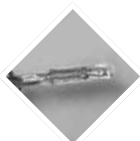

REFERENCE	DIAMETER	NB LED	LED	CABLE	P. / 24V
550559	50 cm	100	○	▬	7.2 W - 300 mA



REFERENCE	DIAMETER	NB LED	LED	CABLE	P. / 24V
550560	50 cm	100	●	▬	9.6 W - 400 mA

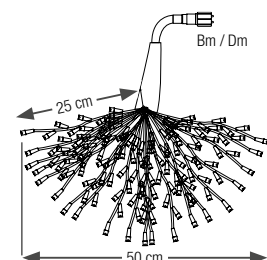

20 branches per bouquet

Perfect in suspension or trees.

Extendable 230V range: Rectified or non-rectified power supply required. Work on 120V to 230V.

Extendable 24V range: Requires a power cable and a transformer.

SPARKLE SUSPENSIONS

24V

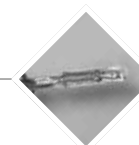

REFERENCE	DIAMETER	NB LED	LED	CABLE	BRANCHES	P. / 24V
551338*	80 cm	175	○	▬	49	3 W - 120 mA
551339*	80 cm	175	●	▬	49	3 W - 120 mA

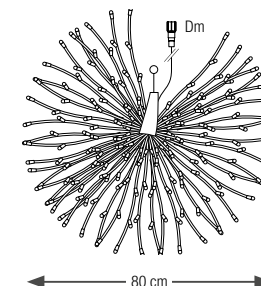

49 branches per bouquet



Watch the animation

Ideal for hanging in trees or upon a street.

Extendable 230V range: Don't forget your power supply.

Extendable 24V range: Requires a power cable and a transformer. Supplied with sling.

DROPLIGHTS

230V



REFERENCE	HGT.	NB LED	LED	CABLE	P. / 230V	EXTEND.
051180	50 cm	50	○	≡	6 W	1+19
550485	50 cm	50	●	≡	6 W	1+19
550250	50 cm	50	●	≡	6 W	1+19
051181	100 cm	72	○	≡	6 W	1+19
550486	100 cm	72	●	≡	6 W	1+19
550251	100 cm	72	●	≡	6 W	1+19

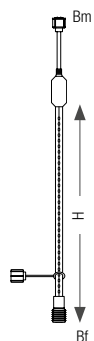

24V



REFERENCE	HGT.	NB LED	LED	CABLE	P. / 24V
550172	50 cm	50	○	≡	2.2 W - 90 mA
550483	50 cm	50	●	≡	2.2 W - 90 mA
550229	50 cm	50	●	≡	2.2 W - 90 mA
550173	100 cm	72	○	≡	2.2 W - 90 mA
550484	100 cm	72	●	≡	2.2 W - 90 mA

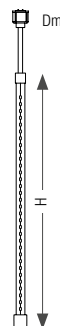

Caen • France



Snowfall effect.

Visible 360°. Easy to insert into a ceiling light, in the middle of a curtain or icicle lights.

Extendable P&L 230V range : Provide a non-rectified power supply. Work on 120V to 230V.

Extendable P&L 24V range: Requires a power cable and a transformer.

SPARKLE DROPLIGHTS

230V



REFERENCE	HGT.	NB LED	LED	CABLE	P. / 230V
550725	50 cm	36	○	▬	9 W
550726	100 cm	72	○	▬	12 W
550765	50 cm	36	●	▬	9 W
550766	100 cm	72	●	▬	12 W

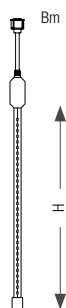

24V



REFERENCE	HGT.	NB LED	LED	CABLE	P. / 24V
550727	50 cm	36	○	▬	4 W - 170 mA
550728	100 cm	72	○	▬	4.2 W - 175 mA
550767	50 cm	36	●	▬	4.2 W - 170 mA
550768	100 cm	72	●	▬	4.2 W - 175 mA

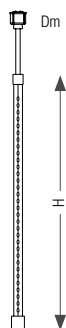

Chasing & crackling effect

Visible 360°. Easy to insert into a ceiling light, in the middle of a curtain or icicle lights.

Extendable P&L 230V range : Provide a non-rectified power supply.

Work on 120V to 230V.

Extendable P&L 24V range: Requires a power cable and a transformer.



Watch the animation

MINI DROPLIGHTS GARLAND

230V/12V



REFERENCE	HGT.	LGT	NB LED	LED	DROPLIGHTS	CABLE	P. / 230V	EXTEND.
059805	0.50 m	11 m	144	○	6	▬	9 W	1+5

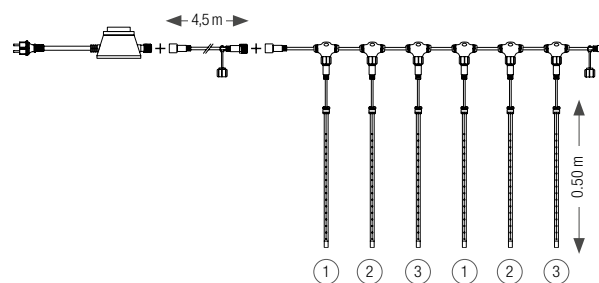

Snowfall effect.

Garland of 6 droplights synchronized in pairs.

Not compatible with P&L.



CANDLES ICICLE LIGHT

24V



REFERENCE	DIMENSIONS	NB LED	LED	CABLE	P./24V	EXTEND.
551277*	L 5 x H 54 cm	10			9 W - 36 mA	1+6

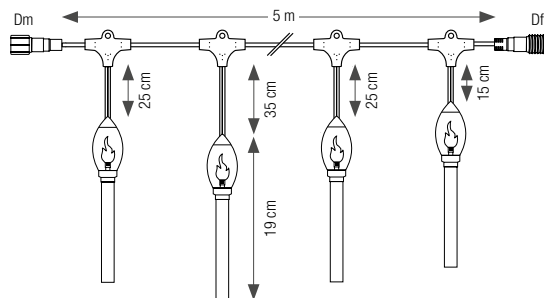

Flame animation.

10 falls with hanged candles.
 360° visibility. Easy to integrate into a ceiling, or to alternate with icicle lights.
 Requires a power supply and transformer.

Laval • France



Watch the animation

FREE-STANDING CANDLE

24V



REFERENCE	DIMENSIONS	NB LED	LED	CABLE	P. / 24V	EXTEND.
551310*	H 30 cm	1			1 W - 36 mA	1+79

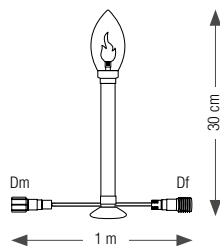

Flame animation.

Illuminated candle.

Requires a power supply and transformer.

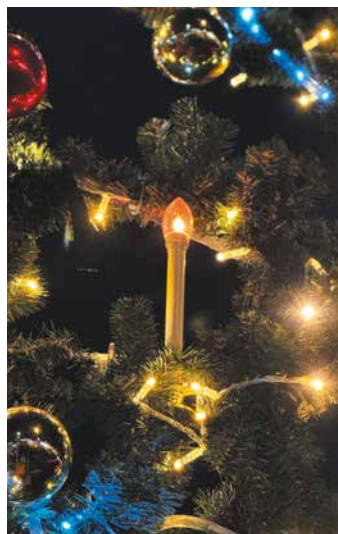

Watch the animation



ZEF CURTAIN LIGHT SPARKLE

230V



REFERENCE	WIDTH	HGT.	NB LED	LED	CABLE	P. / 230V	EXTEND.
551174	0.9 m	3.60 m	240			49 W	1+3
551173	0.9 m	3.60 m	240			49 W	1+3

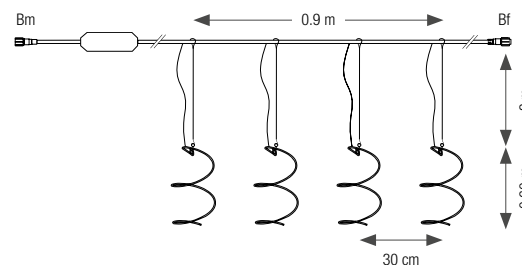

Scrolling animation for your trees and city entrances.

Chasing and crackling effect. Ready to use.

Curtain light of 4 mini decorations made of chasing rope light, with self-supporting steel wire. Anti-UV treated PVC. Fastening points included. Requires an unrectified power cable.



Watch the animation



Bordeaux • France

SUR'LINE MINI DECOR ICICLE LIGHT

230V

P&L
230V SMD LED DC

REFERENCE	WIDTH	HGT.	LED	CABLE	P./230V	EXTEND.
550018	1.50 m	4 m	○	—	69 W	1+4
550019	1.50 m	4 m	●	—	69 W	1+4

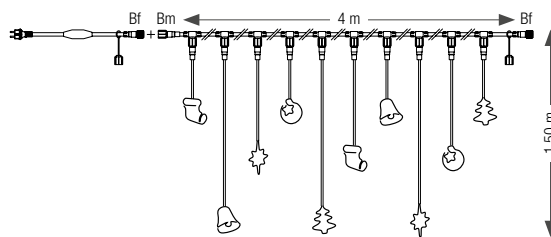

High brightness SMD LED.

With self-supporting steel cable.

Ref.550018: ivory white LED.



MICROLED WATERFALL SUSPENSION



24V

P&L
24V



DC

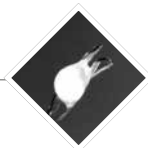

REFERENCE	LGT	NB LED	LED CABLE	P. / 24V	EXT.
550219	2.40 m	1152	○ —	46 W - 1900 mA	1+2

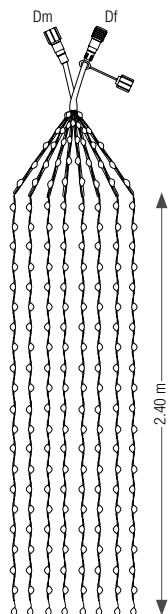

MICROLED WATERFALL SUSPENSION WITH LEAVES



24V

P&L
24V



DC

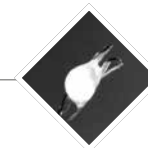

REFERENCE	LGT	NB LED	LED CABLE	P. / 24V	EXT.
550530	2.40 m	1152	○ —	46 W - 1900 mA	1+2

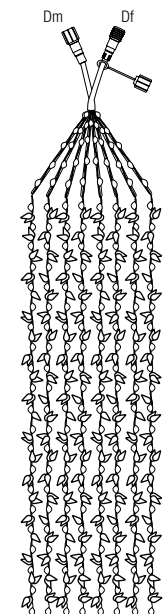

MicroLED, 3 times brighter.

Pre-programmed glittering effect (1/4 LED). Indoor/outdoor use.
Extendable. Ivory white LED.
Requires a power cable and a 24V transformer.
Connect up to 3 products in series.



Watch the animation



BRANCHES, TREES
& FLOORSTANDING DECORS

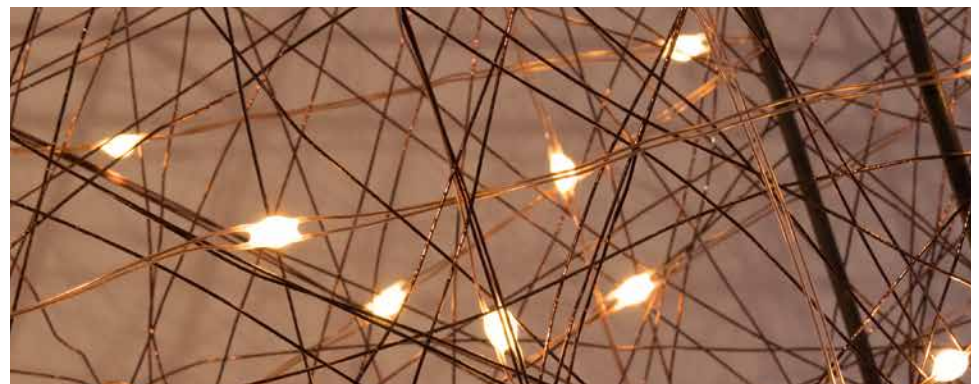

CEILING LIGHTS BRANCHES

230V



REFERENCE	DIMENSIONS	NB LED	LED	BRANCHES	P. / 230V	EXTEND.
050508	Ø 0.70 x L 3.50 m	300	○	—	20 W	1+16
550821	Ø 0.70 x L 3.50 m	300	●	—	20 W	1+16



REFERENCE	DIMENSIONS	NB LED	LED	BRANCHES	P. / 230V	EXTEND.
059243	Ø 0.70 x L 3.50 m	300	○	—	25 W	1+13



REFERENCE	DIMENSIONS	NB LED	LED	BRANCHES	P. / 230V	EXTEND.
050541	Ø 0.70 x L 1.50 m	150	○	—	9 W	1+39

Volume effect.

Semi-rigid branches, simple and easy to install.
Preprogrammed glittering effect (1/5 LED).

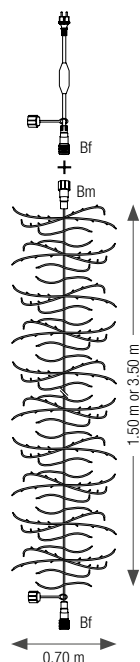

BRANCH GARLAND

230V



REFERENCE	DIMENSIONS	NB LED	LED	CABLE	P. / 230V	EXTEND.
551167	Ø 1 x L 2 m	320	○	—	18 W	1+19
551168	Ø 1 x L 2 m	320	●	—	18 W	1+19

Volume effect.

Semi-rigid branches, simple and easy to install.
Fastening ring at each end. Pre-programmed glittering effect (1/5 LED).
Rectified power supply required.

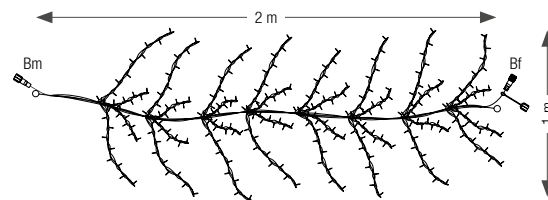

MICROLED CHRISTMAS TREE AND STARS

230V/24V

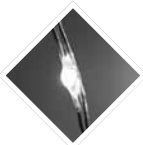

REFERENCE	DESCRIPTION	DIMENSIONS	NB LED	LED	CABLE	P. / 230V
550516	3D Christmas tree	H 118 x W 94 x D 15 cm	600	○	—	21W
550517	3D Christmas tree	H 98 x W 87 x D 12 cm	240	○	—	12 W
550518	3D Star	H 118 x W 118 x D 15 cm	600	○	—	25 W
550519	3D Star	H 98 x W 98 x D 12 cm	240	○	—	16 W
550520	3D Star	H 75 x W 75 x D 7 cm	200	●	—	16 W

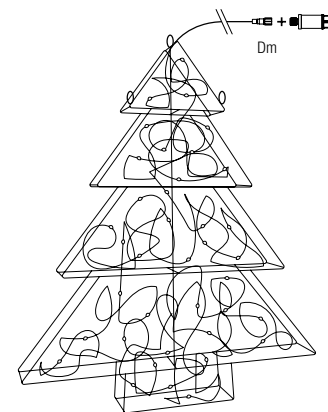
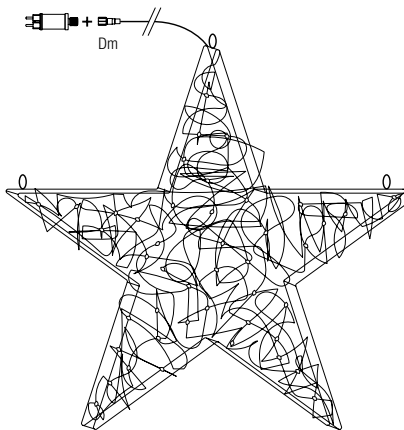

Decorations for hanging or standing.

Gold lacquered aluminium frame, except from ref.550520 (brown lacquered).
 3 attachment rings. Compatible with our 24V transformers.
 Max distance between the first and the last product: 80m of wire.



Zoom ref. 550520



Zoom ref. 550519

MICROLED CARACAS PALM TREES

230V/4,5V



REFERENCE	HGT.	NB LED	LED	TREE	P. / 230V
550646	1.52 m	196	●	■	10.5 W
550647	1.82 m	280	●	■	11.5 W
550648	2.13 m	302	●	■	12.5 W

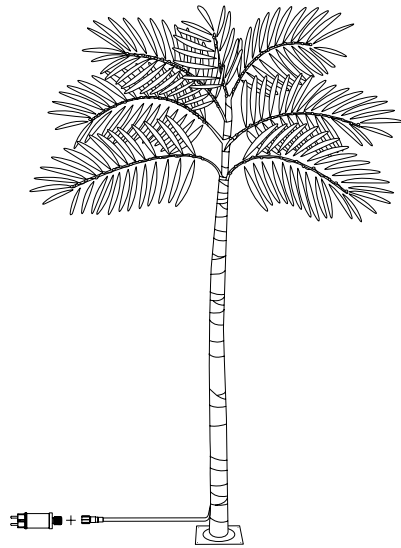

Guaranteed tropical effect.

Floorstanding microLED tree. Indoor/Outdoor use. Suitable for use inside buildings not ruled by ERP. Not compatible with 24V P&L. Transformer included.



ROPE LIGHTS



MICROLED ROPE LIGHTS

24V



REFERENCE	LENGHT	LED	P. / 230V	P. / 24V	MAX LGT.
550978*	2 m	120 ○	18 W	9.6 W - 400 mA	2 m
550979*	2 m	120 ●	18 W	9.6 W - 400 mA	2 m
550990*	4 m	240 ○	36 W	19.2 W - 800 mA	4 m
550991*	4 m	240 ●	36 W	19.2 W - 800 mA	4 m

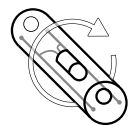

Intense brightness 360°

Ideal for decorating e-deco backdrops or small custom structures.

Non-extendable, non-cuttable.

60 microLED/m, UV-resistant. Includes power cable ref.032371 and transformer ref.061218.

CONNECTION KIT P&L 24V

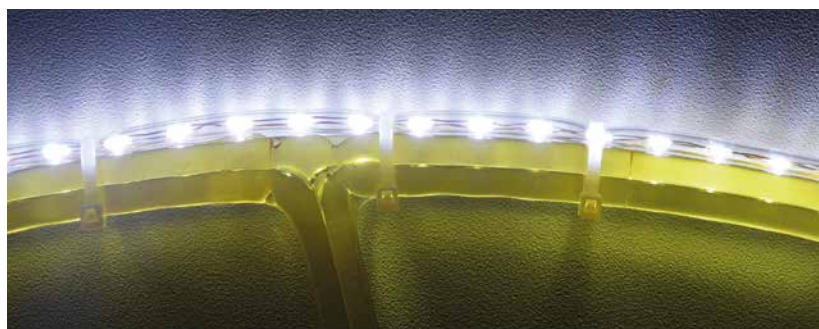
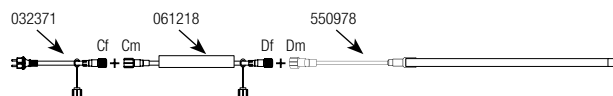

CHASING ROPE LIGHTS

230V



REFERENCE	LGT	NB LED	LED	P. / 230V
550713	1 m	36	○	13 W
550714	1 m	36	●	13 W
550482	1 m	36	●	13 W
550716	2 m	60	○	19 W
550717	2 m	60	●	19 W
550226	2 m	60	●	13 W
550719	5 m	120	○	30 W
550720	5 m	120	●	30 W
550227	5 m	120	●	30 W
550722	10 m	240	○	80 W
550723	10 m	240	●	80 W

24V



REFERENCE	LGT	NB LED	LED	P. / 24V
550701	1 m	30	○	9 W - 375 mA
550702	1 m	30	●	9 W - 375 mA
550254	1 m	30	●	9 W - 375 mA
550704	2 m	60	○	12.5 W - 520 mA
550705	2 m	60	●	12.5 W - 520 mA
550223	2 m	60	●	12.5 W - 520 mA
550707	5 m	120	○	24 W - 1000 mA
550708	5 m	120	●	24 W - 1000 mA
550224	5 m	120	●	24 W - 1000 mA
550710	10 m	240	○	48 W - 2000 mA
550711	10 m	240	●	48 W - 2000 mA
550225	10 m	240	●	48 W - 2000 mA

Chasing effect.

Anti-UV treated, Ø 13 mm.

Extendable P&L 230V range : Provide a non-rectified power supply. Extendable P&L 24V range : Requires a power supply and transformer.



Watch the animation

ACCESSORY 230V

REFERENCE	DESCRIPTION	LGT
032376	White power supply cable	L 3 m

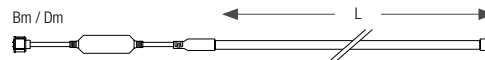

Béziers • France

SPARKLING ROPE LIGHTS

FLASHING ROPE LIGHTS

230V

24V

230V



REFERENCE	LGT	NB LED	LED	P. / 230V
550729	2 m	60	○	19 W
550756	2 m	60	●	19 W

REFERENCE	LGT	NB LED	LED	P. / 24V
550730	2 m	60	○	8.9 W - 370 mA
550757	2 m	60	●	8.9 W - 370 mA

REFERENCE	LGT ROLL	LED	P. / 230V	CUTTABLE	MAX LGT. (1)
550054	30 m	○	3.5 W /m	every 2 m	100 m
550055	30 m	●	3.5 W /m	every 2 m	100 m
550057	30 m	●	3.5 W /m	every 2 m	100 m
550056	30 m	●	3.5 W /m	every 2 m	100 m
550058	30 m	●	3.5 W /m	every 2 m	100 m

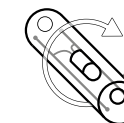

Intense brightness 360°

ACCESSORY 230V

REFERENCE	DESCRIPTION	LGT
032376	White power supply cable	L 3 m

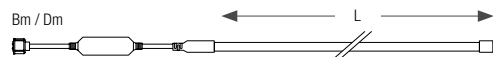

Chasing & crackling effect.

Anti-UV treated, Ø 13 mm.

Extendable P&L 230V range : Provide a non-rectified power supply (ref. 032376).

Extendable P&L 24V range: Requires a power supply and transformer.

CONNECTION KIT

REFERENCE	COMPOSITION	CABLE
550732	Power supply cable with rectifier 4 A + round tip connector + end cap + heat shrink sleeve	—
550733	Power supply cable with rectifier 4 A + round tip connector + end cap + heat shrink sleeve	□

Flashing animation 1 LED in 2.

36 LED/m, anti-UV treated, Ø 13 mm.

Requires a connection kit (réf.550732 ou 550733).



Watch the animation



Watch the animation

ROPE LIGHTS SUR'LINE

230V

P&L
230V SMD LED DC

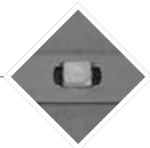

REFERENCE	LGT	LED	P. / 230V	EXTEND.
051010	3 m	○	27 W	50 m max
051032	3 m	●	21 W	50 m max
051033	3 m	●	27 W	50 m max
051012	5 m	○	45 W	50 m max
051013	5 m	○	45 W	50 m max
051034	5 m	●	35 W	50 m max
051035	5 m	●	45 W	50 m max
051036	7 m	●	49 W	50 m max

High brightness SMD LED.
92 SMD LED /m, extendable.

SUR'LINE ACCESSORIES

REFERENCE	DESCRIPTION	LGT
032353	Fastening rail	2 m
058989BL	White power supply cable	1.50 m

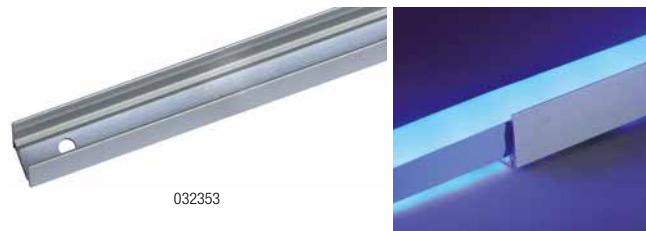
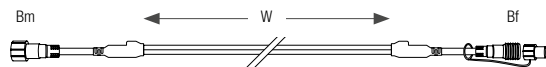

032353



ROPE LIGHTS ROP'LINE

230V

P&L 230V SMD LED DC

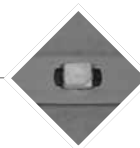

REFERENCE	LGT ROLL	LED	P. / 230V	CUTTABLE	MAX LGT. ⁽¹⁾
051264	30 m	○	6 W /m	every 1 m	100 m
550313	30 m	○	6 W /m	every 1 m	100 m
051265	30 m	○	6 W /m	every 1 m	100 m
550118	30 m	●	3.3 W /m	every 1 m	100 m
550119	30 m	●	3.3 W /m	every 1 m	100 m
550120	30 m	●	3.3 W /m	every 1 m	100 m
550121	30 m	●	3.3 W /m	every 1 m	100 m

High brightness SMD LED.

60 LED SMD/m.

Dual-sided rope light Ø 13 mm, extendable.
Requires a connection kit (ref.550732).

⁽¹⁾ Max. length with ref.550732.

CONNECTION KIT 230V

REFERENCE	COMPOSITION	CABLE
550732	Power supply cable with rectifier 4 A + round tip connector + end cap + heat shrink sleeve	—
550733	Power supply cable with rectifier 4 A + round tip connector + end cap + heat shrink sleeve	—



HIGHT QUALITY ROPE LIGHTS

Very high quality rope lights Intense brightness 360°.

36 LED/m, anti-UV treated, Ø 13 mm.

230V - Without power supply

DC

REFERENCE	LGT ROLL	LED	P. / 230V	CUTTABLE	MAX LGT. ⁽¹⁾
058911	30 m	○	2.5 W /m	every 2 m	100 m
050567	90 m	○	4 W /m	every 1 m	100 m
059544	30 m	○	2.5 W /m	every 2 m	100 m
050689	90 m	○	4 W /m	every 1 m	100 m
058914	30 m	●	1.6 W /m	every 3.30 m	100 m
550822	30 m	●	2.5 W /m	every 2 m	100 m
550823	90 m	●	2.5 W /m	every 2 m	100 m
050686	90 m	●	4 W /m	every 1 m	100 m
058912	30 m	●	2.5 W /m	every 2 m	100 m
050685	90 m	●	4 W /m	every 1 m	100 m
058913	30 m	●	2.5 W /m	every 2 m	100 m
050688	90 m	●	4 W /m	every 1 m	100 m
058915	30 m	●	1.6 W /m	every 3.30 m	100 m
050687	90 m	●	4 W /m	every 1 m	100 m
059974	30 m	●	3.0 W /m	every 1.50 m	100 m

⁽¹⁾ Max. length with ref.550732.

The one you can find on our decorations.

Requires a connection kit (ref.550732).

CONNECTION KIT

REFERENCE	COMPOSITION	CABLE
550732	Power supply cable with rectifier 4 A + round tip connector + end cap + heat shrink sleeve	—
550733	Power supply cable with rectifier 4 A + round tip connector + end cap + heat shrink sleeve	□



230V - Power supply included

DC

REFERENCE	LGT ROLL	LED	P. / 230V	CUTTABLE	MAX LGT.
550307	45 m	○	2.3 W /m	every 1.5 m	100 m
550308	45 m	○	2.3 W /m	every 1.5 m	100 m
550311	45 m	●	2.3 W /m	every 1.5 m	100 m
550309	45 m	●	2.3 W /m	every 1.5 m	100 m
550310	45 m	●	2.3 W /m	every 1.5 m	100 m

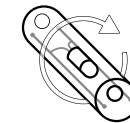

Intense brightness 360°

Supplied with a mounted overmoulded power cable.

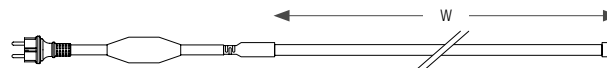

HIGHT QUALITY ROPE LIGHTS

24V



REFERENCE	LGT ROLL	LED	P. / 230V	P. / 24V	CUTTABLE	MAX LGT. (1)
051079	30 m	○	2.3 W /m	2.89 W /m - 120 mA	every 16.6 cm	20 m
550736	30 m	○	2.3 W /m	2.89 W /m - 120 mA	every 16.6 cm	20 m
051083	30 m	●	2.3 W /m	1.4 W /m - 58 mA	every 33 cm	20 m
051082	30 m	●	2.3 W /m	2.89 W /m - 120 mA	every 16.6 cm	20 m
051081	30 m	●	2.3 W /m	2.89 W /m - 120 mA	every 16.6 cm	20 m
550577	30 m	●	2.3 W /m	1.4 W /m - 58 mA	every 16.6 cm	20 m

(1) Max. length with transformer ref.061219.

36 LED/m, anti-UV treated, Ø 13 mm.
Requires a connection kit.

Extendable 24V range: find all accessories p.271.

CONNECTION KIT P&L 24V

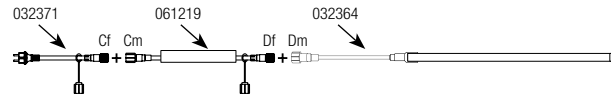

Detroit • U.S.A.

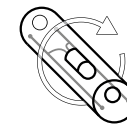

Intense brightness 360°

STANDARD ROPE LIGHTS

230V

DC

REFERENCE	LENGTH ROLL	LED	P. / 230V	CUTTABLE	MAX LGT.
059711	44 m	●	1.4 W /m	every 4 m	100 m
059715	44 m	●	1.4 W /m	every 4 m	100 m
059712	44 m	●	1.4 W /m	every 4 m	100 m
059713	44 m	●	1.4 W /m	every 4 m	100 m
059714	44 m	●	1.4 W /m	every 4 m	100 m

Standard rope lights.

18 LED/m, anti-UV treated, Ø 13 mm.
Requires a connection kit (ref.550732).



Saint Gilles • Reunion Island

CANDY ROPE LIGHT

230V

DC

REFERENCE	LGT ROLL	LED	P. / 230V	CUTTABLE	MAX LGT.
550126	30 m	○	1.8 W /m	every 2 m	100 m

230V CONNECTION KIT

REFERENCE	COMPOSITION	CABLE
550732	Power supply cable with rectifier 4 A + round tip connector + end cap + heat shrink sleeve	—
550733	Power supply cable with rectifier 4 A + round tip connector + end cap + heat shrink sleeve	□

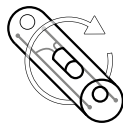

Intense brightness 360°

Candy cane effect.

36 LED/m, anti-UV treated, Ø 13 mm.
Requires a connection kit (ref.550732).



ROPE LIGHT QUICK CONNECTION

CONNECTION KITS

REF.	DESCRIPTION	COMPOSITION	CABLE
550732	Power supply kit	Power supply cable with rectifier 4 A + round tip connector + end cap + heat shrink sleeve	—
550733	Power supply kit	Power supply cable with rectifier 4 A + round tip connector + end cap + heat shrink sleeve	□
059975	Power supply kit	Power supply cable with rectifier 1.6 A + round tip connector + end cap + heat shrink sleeve	—

Find out how to connect your cords easily & quickly.



GUARLANDS AND ROPE LIGHTS ACCESSORIES

ROPE LIGHTS ACCESSORIES

REFERENCE	DESCRIPTION
001867	2 m nylon strip light
331300	1 T-connector
720102	1 transparent heat shrink sleeves ø 19 mm - Lgt: 1.20 m
055193	1 junction kit to connect 2 rope lights together (1 double pin connector + 2 heat shrink sleeves)
201300	10 junction kits 055193
413000	100 nylon clips
351000	100 double pin connectors
354000	100 round tip connectors
513000	100 safety caps
055476	10 safety caps
060959	1.000 white nylon collars 3.6 x 203 mm



060959



001867



331300



720102



550974



513000 / 055476



351000



354000



055193



413000

GUARLANDS ACCESSORIES

REFERENCE	DESCRIPTION
550974	10 white caps

GUINGUETTES
GARLANDS



TRADITIONAL GARLANDS

230V



REF.	LGT	GLOBES	EFFECT	NB LED	LED	CABLE	P. / 230V	EXTEND.
550634	5 m	10 ○	milky	60	○	—	5 W	100 m
550635	5 m	10 ○	milky	60	○	—	5 W	100 m
051026	5 m	10 ⊗	filament	60	●●●●	—	4 W	100 m
051072	5 m	10 ⊗	filament	60	●●●●	—	4 W	100 m

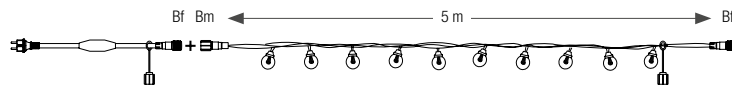

Filament or milky effect.

Unbreakable polycarbonate globes. Non-removable bulbs. Traditionnal effect. Ref.051026 & 051072: 2 yellow, 3 red, 3 green and 2 blue bulbs. Coloured packaging.



Milky effect



Filament effect



Versailles, Guinguette Open Air • France

TRADITIONAL FILAMENT GARLANDS

230V



REF.	LGT	GLOBES	NB LED	CABLE	P. / 230V	EXTEND.
551137	20 m	40 ⊗	40 ○ filament	—	22 W	100 m
551138	20 m	40 ⊗	40 ○ filament	—	22 W	100 m
551136	20 m	40 ⊗	40 ○ filament	—	22 W	100 m

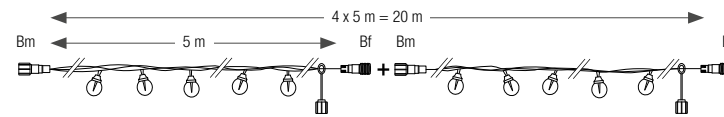

Requires a rectified power cable.



REFERENCE	LGT	GLOBES	NB LED	CABLE	P. / 230V	EXTEND.
551081*	5 m	10 ⊗	10 ○ filament	—	6 W	100 m max
551082*	5 m	10 ⊗	10 ○ filament	—	6 W	100 m max
551083*	5 m	10 ⊗	10 ○ filament	—	5.5 W	100 m max
551084*	5 m	10 ⊗	10 ○ filament	—	5.5 W	100 m max
551085*	5 m	10 ⊗	10 ●●●●● filament	—	5.5 W	100 m max

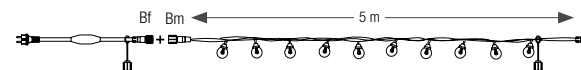

Ref. 551085: 2 yellow, 2 green, 2 red, 1 blue, 1 orange, 1 violet, 1 pink filaments.



LED filament. Extendable.

Transparent polycarbonate globes Ø 45 mm, unbreakable. Non-removable bulbs. Traditionnal effect. One filament per globe.

TRADITIONAL FILAMENT ICICLE LIGHT

230V



REF.	DIMENSIONS	GLOBES	NB LED	CABLE P./230V	EXTEND.
551139	H 0.80 x W 4 m 30	30 filament		10 W	1+4

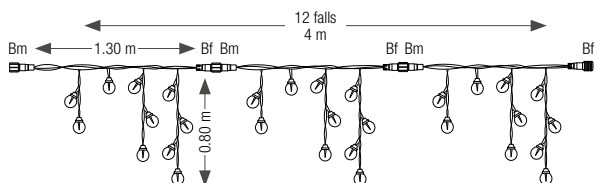

LED filament. Extendable.

Transparent polycarbonate globes Ø 45 mm, unbreakable. Non-removable bulbs. Traditionnal effect. One filament per globe.



Poitiers • France

HARLEQUIN GARLAND

230V



REFERENCE	LGT	GLOBES	NB LED	CABLE P./230V	EXTEND.
551087*	5 m	10	10	5.5 W	100 m max

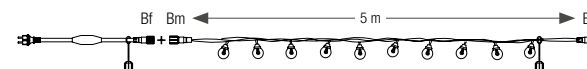

LED filament. Extendable.

Coloured polyethylene globes Ø 60 mm, unbreakable: 2 dark green, 2 red, 1 blue, 2 yellow, 1 light green, 1 violet, 1 pink.

Non-removable bulbs. Traditionnal effect. One filament per globe.





E27 JAVA GARLANDS

230V



REFERENCE	LGT	BULBS	SOCKETS	LED	CABLE	P. BULB	EXTEND.
550300	5 m	10	10 E27	○	—	2.5 W / 44 mA	100 m
550472	5 m	10	10 E27	○	—	2.5 W / 44 mA	100 m
550299	5 m	10	10 E27	●	—	2.5 W / 44 mA	100 m

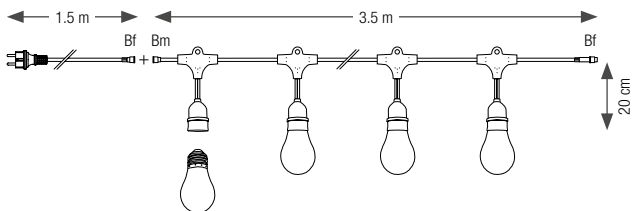

Extendable garland, supplied with plug & bulbs.

E27 LED bulbs Ø 60 mm. Sockets equipped with seals. Coloured packaging.

230V



REFERENCE	LGT	SOCKETS	CABLE	SECT° CABLE	P.SOCKETS	EXTEND.
551070	5 m	10 E27	—	2 x 1.5 mm ²	15 W max	100 m
551069	5 m	10 E27	—	2 x 1.5 mm ²	15 W max	100 m

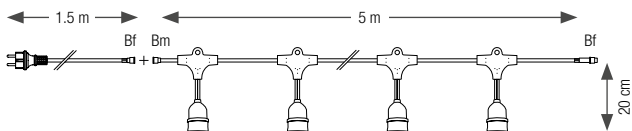

Extendable garland, supplied with plug, without bulbs.

Sockets equipped with seals.

E27 JAVANESE GARLAND

230V



REFERENCE	DIMENSIONS	SOCKETS	CABLE	SECT° CABLE	P.SOCKETS	EXTEND.
551075	H 0.35 x W 5 m	10 E27	—	2 x 1.5 mm ²	15 W max	100 m

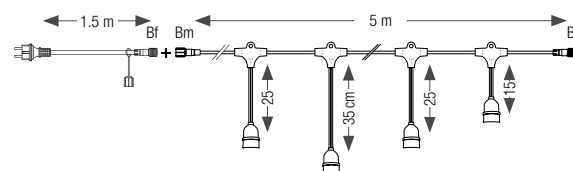

Extendable garland, supplied with plug, without bulb.

Each socket is equipped with a seal. 10 falls of different heights. Fastening rings included.



E27 GARLAND WITHOUT BULB

230V

P&L
230V AC

REFERENCE	LGT	SOCKETS	CABLE	SECT° CABLE	P.SOCKETS	EXTENDABLE
550236	10 m	20 E27		2 x 1.5 mm ²	15 W max	100 m max

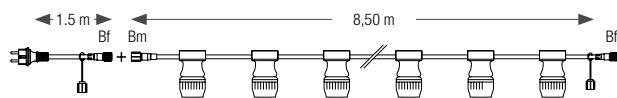





Extendable garland. Supplied with socket, without bulb.

Each socket is equipped with a seal.

E27 GARLANDS TO ASSEMBLE

230V

AC FLAT CABLE GARLAND TO ASSEMBLE

REFERENCE	DESCRIPTION	LGT	COL.	P. / 230 V
057032NRB	Flat cable H05RNH2F 2 x 2.5 mm ²	100 m		4600 W max
059763	100 E27 sockets	-		15 W max
059838	100 seals for E27 sockets	-		-
058260	10 protective end caps	-		-



For professional use only.

These garlands can be assembled according to your requirements with a 100 m cable roll and sockets (100 pieces in a box). Use non-removable screws.

E27 SOCKET SUSPENSION

230V

P&L
230V AC

REFERENCE	LGT	SOCKET	CABLE	SECT° CABLE	P.SOCKETS
550180	1.50 m	E27		2 x 1.5 mm ²	15 W max



Perfect as suspensions in a tree or ceiling lights.

Suspension supplied without bulb.
Requires an unrectified power supply.



B22 GARLANDS WITHOUT BULBS

230V



REFERENCE	LGT	SOCKETS	CABLE	SECT° CABLE	P.SOCKETS
058772	9 m	20 B22	—	2 x 1.5 mm ²	15 W max
058776	15 m	40 B22	—	2 x 1.5 mm ²	15 W max

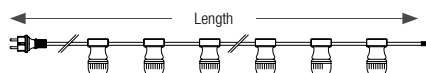

Supplied with plug, without bulb.

ACCESSORY

REFERENCE	DESCRIPTION
050989	100 black seals for B22 sockets

230V



REFERENCE	LGT	SOCKETS	CABLE	SECT° CABLE	P.SOCKETS
058785	50 m	140 B22	—	2 x 1.5 mm ²	15 W max
058828	50 m	200 B22	—	2 x 1.5 mm ²	15 W max
058810	100 m	100 B22	—	2 x 1.5 mm ²	15 W max
058811	100 m	200 B22	—	2 x 1.5 mm ²	15 W max
058242	100 m	300 B22	—	2 x 1.5 mm ²	15 W max

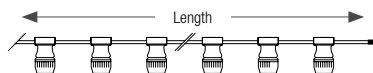

Supplied with plug, without bulb.

B22 GARLANDS TO ASSEMBLE

230V



FLAT CABLE GARLAND TO ASSEMBLE

REFERENCE	DESCRIPTION	LGT	COL.	P. / 230 V
057032NRB	Flat cable H05RNH2F 2 x 2.5 mm ²	100 m	—	4600 W max
031873	100 B22 sockets	-	—	15 W max
058965	100 seals for B22 sockets	-	—	-
058260	10 protective end caps	-	—	-



SINGLE WIRE GARLANDS TO ASSEMBLE

REFERENCE	DESCRIPTION	LGT	COL.	P. / 230 V
060255NR	Single wire H05RN-F 1.5 mm ²	300 m	—	3680 W max
070008BL	100 B22 sockets	-	—	15 W max
059546	100 seals for B22 sockets	-	—	-



For professional use only.

These garlands can be assembled according to your requirements with a 100 m cable roll and sockets (100 pieces in a box). Use non-removable screws.



EXTENDABLE GUINGUETTE B22 GARLAND

230V



REFERENCE	LGT	BULB	SOCKETS	LED	CABLE	P./ 230 V	EXTEND.
551273*	10 m	10 G45	10 B22			14 W	100 m

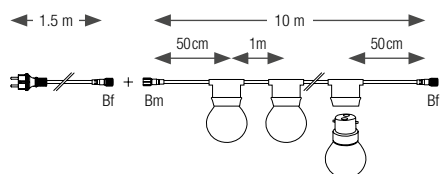

Extendable garland with plug and bulbs.

Optimized B22 3 LED bulbs (Ø 45 x H 65 mm) in unbreakable polycarbonate. Sockets with seals. Round rubber cable.

FILAMENT EXTENDABLE GUINGUETTE B22 GARLAND

230V



REFERENCE	LGT	BULB	SOCKETS	LED	CABLE	P./ 230 V	EXTEND.
551274*	10 m	10 ST45	10 B22			22 W	100 m

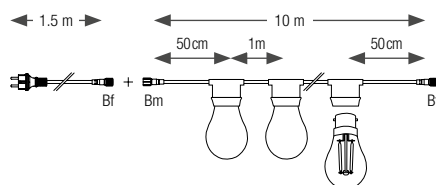

Extendable garland with plug and bulbs.

Optimised B22 2 LED filament bulbs (Ø 45 x H 80 mm) in unbreakable polycarbonate. Sockets with seals. Round rubber cable.

COLORS GUINGUETTE B22 GARLAND

230V



REFERENCE	LGT	BULB	SOCKETS	LED	CABLE	P. AMPOULE	EXTEND.
059783	10 m	10 G45	10 B22			0.5 W	-

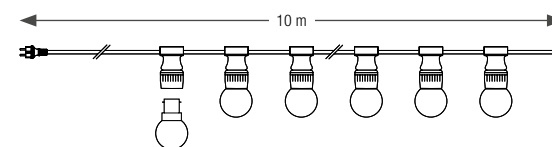

Garland supplied with plug and bulbs, non-extendable.

Ref. 059783: 2 blue, 2 green, 3 yellow, 3 red bulbs. Sockets with seals.



LIGHT BULBS



What are the differences between E27 and B22 bulbs?

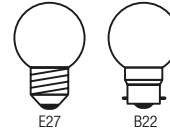

E27 and B22 bulbs differ in their base type. The E27, with its 27 mm screw base, is the most commonly used model. The B22, on the other hand, has a 22 mm bayonet base.

What are the differences between A60, G45, G50 and ST45 bulbs?

These bulbs differ in size and shape. The A60, with its 60mm diameter, adopts a classic pear-shaped silhouette, ideal for Java or Javanise-style garlands. The more compact G45 (45mm) has a globe shape, ideal for garlands or light displays. The G50, with a diameter of 50mm, offers a slightly larger globe shape, ideal for decorative and vintage lighting. Finally, the ST45, also 45mm in diameter, adopts an elongated

Edison-type shape, perfect for warm, designer lighting.

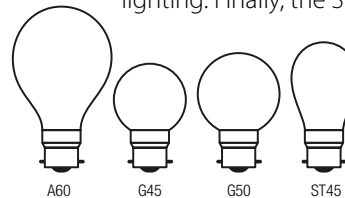

All our bulbs are 100% LED.

What is an optimised bulb?

Our optimised bulbs are designed to maximize energy efficiency while guaranteeing outstanding visual performance.

They combine energy savings, durability and respect for the environment, without compromising on luminosity.

OPTIMISED E27 BULBS A60 WARM COLORS



REFERENCE	DESCRIPTION	CAP	DIAM.	NB LED	GLOBE	P. / 230 V
551079*	5 bulbs	E27	60 mm	5		2.5 W

Large bulbs, very high brightness.

Set of 5 bulbs, tinted polycarbonate globe. Warm colors (yellow, red, orange, violet and pink). Coloured packaging.

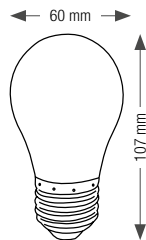

551079



Optimised SMD LED bulbs

The power displayed corresponds to the real power consumption.



E27 A60 BULBS



REFERENCE	CAP	DIAM.	NB LED	GLOBE	P. / 230 V
550473	E27	60 mm	11		2.5 W - 44 mA
550474	E27	60 mm	11		2.5 W - 44 mA
551145	E27	60 mm	11		2.5 W - 44 mA
550476	E27	60 mm	11		2.5 W - 44 mA
550475	E27	60 mm	11		2.5 W - 44 mA
550479	E27	60 mm	11		2.5 W - 44 mA
550478	E27	60 mm	11		2.5 W - 44 mA



Large bulbs, very high brightness.

Set of 5 bulbs, tinted polycarbonate bulb. Coloured packaging.

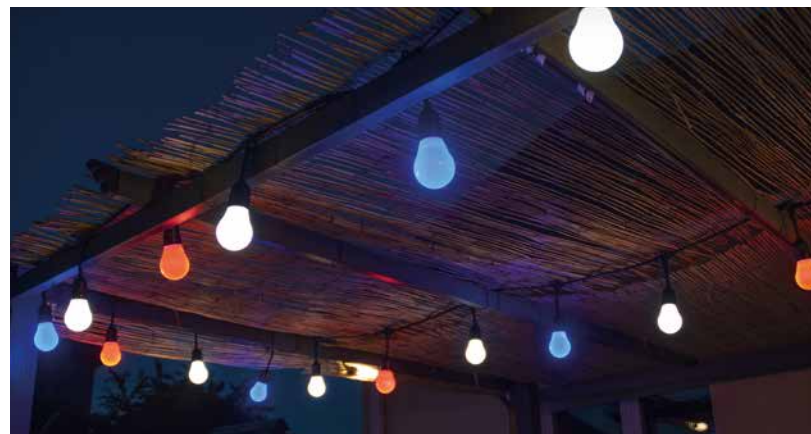

OPTIMISED E27 BULBS A60 FILAMENT



REFERENCE	DESCRIPTION	CAP	DIAM.	NB LED	GLOBE	P. / 230 V
551078	5 bulbs	E27	60 mm	2	⊙ ⊘	2 W



Filament LED. Large size bulbs, very high luminosity.

Set of 5 bulbs, transparent polycarbonate globe. Coloured packaging.



E27 BULB FLAME



REFERENCE	CAP	DIAMETER	HEIGHT	NB LED	GLOBE	P. / 230 V
550122	E27	60 mm	134 mm	96	⊙ ⊘	4.4 W - 38 mA



B22 BULB FLAME



REFERENCE	CAP	DIAMETER	HEIGHT	NB LED	GLOBE	P. / 230 V
550087	B22	60 mm	134 mm	96	⊙ ⊘	4.4 W - 38 mA



the flame will always burn upwards, no matter which way up you use the bulb.

White polycarbonate globe.
Work on 120V to 230V.
P. / 120V: 4.4 - 69 mA.



Watch the animation

OPTIMISED E27 BULBS G45 WARM COLORS



REFERENCE	DESCRIPTION	CAP	DIAM.	NB LED	GLOBE	P. / 230 V
551080*	5 bulbs	E27	45 mm	3		1.3 W

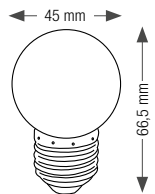

Warm, festive colors.

Set of 5 bulbs, tinted polycarbonate globe. Warm colors (yellow, red, orange, violet and pink).
Coloured packaging.



551080



Optimised SMD LED bulbs

The power displayed corresponds to the real power consumption.



E27 BULBS G45 FILAMENT



REFERENCE	DESCRIPTION	CAP	DIAMETER	NB LED	GLOBE	P. / 230 V
550167	20 bulbs	E27	45 mm	1		3.22 W - 14 mA
550775*	20 bulbs	E27	45 mm	1		1.4 W - 6 mA
550210	20 bulbs	E27	45 mm	1		3.22 W - 14 mA



B22 BULBS G45 FILAMENT



REFERENCE	DESCRIPTION	CAP	DIAMETER	NB LED	GLOBE	P. / 230 V
550166	20 bulbs	B22	45 mm	1		3.22 W - 14 mA
551290*	20 bulbs	B22	45 mm	1		1.40 W - 14 mA
550201	20 bulbs	B22	45 mm	1		3.22 W - 14 mA
550205	20 bulbs	B22	45 mm	1		3.22 W - 14 mA



Filament effect.

Set of 20 bulbs, transparent polycarbonate globe.
Ref.550210 : 5 red + 5 green + 5 yellow + 5 blue bulbs.



OPTIMISED B22 G45 BULBS



REFERENCE	DESCRIPTION	CAP	DIAM.	NB LED	GLOBE	P. / 230 V
551149	1 bulb	B22	50 mm	5	○ ○	2 W
550932	20 bulbs	B22	45 mm	3	○ ○	1.4 W
550933	20 bulbs	B22	45 mm	3	○ ○	1.4 W
550934	20 bulbs	B22	45 mm	3	● ●	1.4 W
550935	20 bulbs	B22	45 mm	3	● ●	1.4 W
550936	20 bulbs	B22	45 mm	3	● ●	1.4 W
550937	20 bulbs	B22	45 mm	3	● ●	1.4 W



Optimised SMD LED bulbs

The power displayed corresponds to the real power consumption.



B22 G45 BULBS



REFERENCE	DESCRIPTION	CAP	DIAM.	NB LED	GLOBE	P. / 230 V
050992	1 bulb	B22	50 mm	18	○ ○	1.8 W - 27 mA
050883	20 bulbs	B22	45 mm	3	○ ○	0.5 W - 24 mA
050885	20 bulbs	B22	45 mm	3	● ●	0.5 W - 24 mA
050887	20 bulbs	B22	45 mm	3	● ●	0.5 W - 24 mA
050888	20 bulbs	B22	45 mm	3	● ●	0.5 W - 24 mA



High brightness SMD LED.

Tinted polycarbonate globe.
18 LED bulb: work on 120V to 230V.



B22 BULBS G45 COLOUR-CHANGING



REFERENCE	DESCRIPTION	CAP	DIAM.	NB LED	GLOBE	P. / 230 V
059080	4 pre-programmed bulbs	B22	50 mm	14	● ○	1.5 W - 47 mA

Changing colours animation.

Tinted polycarbonate globe. Work on 120V to 230V.
14 synchronized animations, without animator.



Watch the animation

B22 BULBS G45 SPHERES



REFERENCE	CAP	DIAM.	NB LED	GLOBE	P. / 230 V
050744	B22	50 mm	32 ● ○	○	2 W - 20 mA
050745	B22	50 mm	32 ○ ○	○	2 W - 20 mA

High brightness SMD LED.



E27 BULBS SUPER FLASH



REFERENCE	CAP	DIAM.	NB LED	GLOBE	P. / 230 V
050857	E27	45 mm	18	○	2 W - 7 mA



B22 BULBS SUPER FLASH



REFERENCE	CAP	DIAM.	NB LED	GLOBE	P. / 230 V
550235	B22	45 mm	6	○	5 W - 20 mA



Work on 120V to 230V.
Approximately 30 flashes/minute on 120 V.
Approximately 45 flashes/minute on 230 V.

B22 BULBS FLASH



REFERENCE	CAP	DIAMETER	NB LED	GLOBE	P. / 230 V
051289	B22	45 mm	4	○	0.9 W - 5 mA
051266	B22	45 mm	4	○	0.9 W - 5 mA
051268	B22	45 mm	4	○	0.9 W - 5 mA
051267	B22	45 mm	4	○	0.9 W - 5 mA



High brightness SMD LED.

Approximately 45 flashes/minute on 230 V.



CONNECTOR BULBS FLASH



REFERENCE	DIAMETER	NB LED	GLOBE	CABLE	P. / 230 V
050761	40 mm	24	○	—	0.8 W - 3.5 mA
050762	40 mm	24	○	—	0.8 W - 3.5 mA

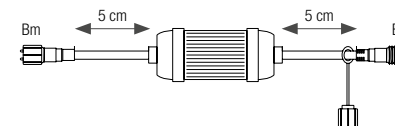

High brightness SMD LED.

Suitable for garlands with B connector.
Approximately 60 flashes/minute.
Work on 120V to 230V.



PLUG & LIGHT



Plug & Light modularity

All our ranges of luminous decorations can be interconnected using Plug & Light technology. Mix and match products, colors, and animations to your liking.



Contact us for personalized support.

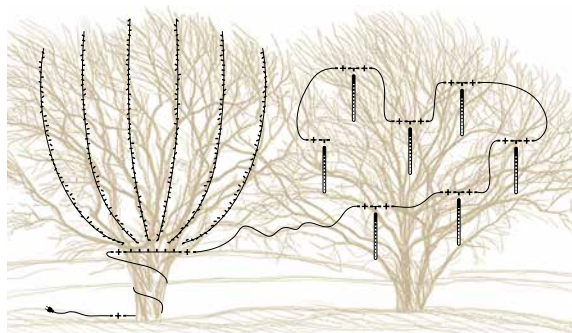

DECORATING TREES

Whether you prefer 'Champagne glass style' or 'snowfall' installation, you can easily install your light strings and hanging lights with our **extensions** and **collectors**.

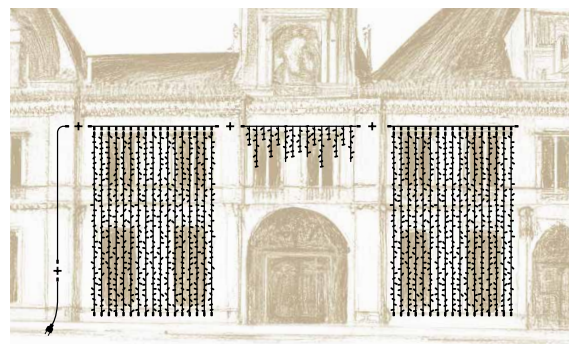

CLADDING A FACADE

Adapt your decoration to the architecture of your building by alternating **extension cords**, curtains and friezes according to your needs, all powered by a single **electrical supply**.



INSTALL AN ACROSS-THE-STREET DISPLAY

Use our **T-connectors** to insert decorations between your strings lights. Let your imagination run wild!

How to choose between 230V and 24V?



230V PLUG & LIGHT

These products can be **interconnected and extended**. Powered by transformers, they operate on safety extra-low voltage (SELV $\leq 50V$). They offer enhanced safety for the public, are discreet (transparent PVC cable), and suitable for international use. However, their wiring, whether in series or parallel, can be more complex, requiring precise calculation of total power to select the appropriate transformer.

24V PLUG & LIGHT

These products can be **interconnected and extended**. Powered by transformers, they operate on safety extra-low voltage (SELV $\leq 50V$). They offer **enhanced safety for the public**, are **discreet** (transparent PVC cable), and suitable for international use. However, their wiring, whether in series or parallel, can be more complex, requiring precise calculation of total power to select the appropriate transformer.

230V PLUG & LIGHT CONNECTORS

P&L
230V

RECTIFIED POWER SUPPLY CABLE

REFERENCE	CABLE	LGT.	CONNECTOR
550663		0.25 m	A
550662		0.25 m	A
550665		0.25 m	B
550664		0.25 m	B

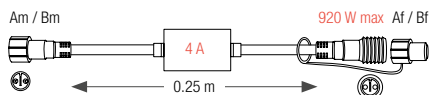

RECTIFIED POWER SUPPLY CABLE

REFERENCE	CABLE	LGT.
058989BL		1.50 m

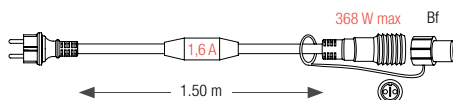

POWER SUPPLY CABLE

REFERENCE	CABLE	LGT.	CONNECTOR P.	/ 230 V
550734		1.5 m	Bf	1840 W
550735		1.5 m	Bf	1840 W
300002		3 m	Af	3680 W
300001		3 m	Af	3680 W
050476		3 m	Bf	1840 W
032376		3 m	Bf	1840 W
050477		5 m	Bf	1840 W

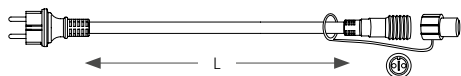

CONNECTORS Ø 2.35 BETWEEN GARLAND AND ROPE LIGHT

REFERENCE	CABLE	LGT.
032187		0.30 m
032338		0.30 m
031912		1 m

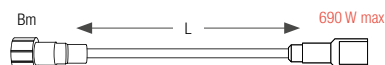

CONNECTORS Ø 2.35 BETWEEN ROPE LIGHT AND GARLAND

REFERENCE	CABLE	LGT.
031908		0.50 m
032375		0.30 m

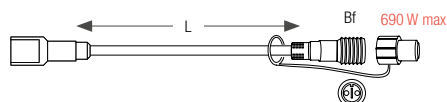

A-A EXTENSION CABLE

REFERENCE	CABLE	LGT.
058815		2 m
032283		2 m

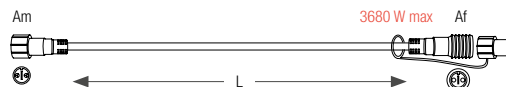

B-B EXTENSION CABLE

REFERENCE	CABLE	LGT.
032190		1 m
032374		1 m
059072		2 m
300034		2 m
031903		3 m
032342		3 m
300036		5 m
300035		5 m



RECTIFIED CONNECTORS TO SUPPLY ROPE LIGHTS

REFERENCE	CABLE	LGT.
032189		0.40 m
032339		0.40 m

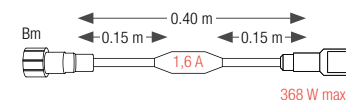

ADAPTER FROM A TO B

REFERENCE	CABLE	LGT.
059238		0.15 m

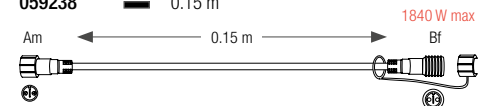

2 WIRE STRIPPED MALE CABLES ALLOWING TO SUPPLY A DECOR

REFERENCE	CABLE	LGT.
058940		3 m
032188		0.30 m



2 WIRE STRIPPED FEMALE CABLES

REFERENCE	CABLE	LGT.
058968		3 m

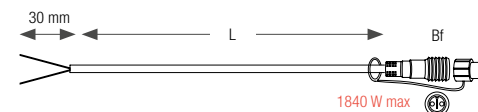

230V PLUG & LIGHT CONNECTORS

P&L
230V

CHROMEX

CONNECTION CABLE

BETWEEN B-B GARLAND AND SOCKET

REFERENCE	CABLE LGT.	CAP
059549	0.20 m	B22
032337	0.20 m	B22
050487	0.40 m	E27

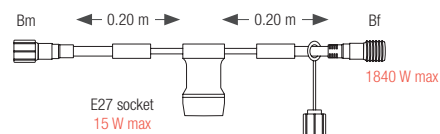
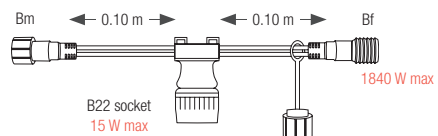

ADAPTER

SOCKET B22 TO CONNECTOR B

REFERENCE	CABLE LGT.
059910	0.37 m

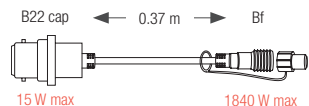

T CONNECTORS

REFERENCE	CABLE LGT.
032093	0.15 m
032279	0.50 m

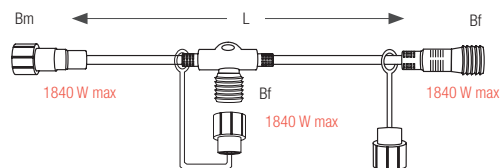

Y CONNECTOR

REFERENCE	CABLE LGT.
058814	1.50 m

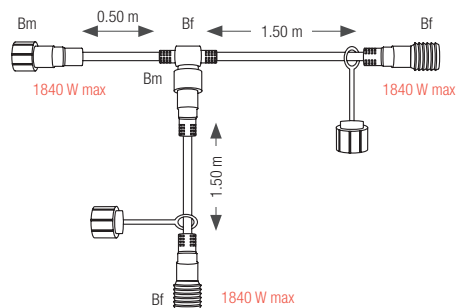

COLLECTOR CABLE 4 FALLS

REFERENCE	CABLE LGT.
058919	1 m
050479	1 m

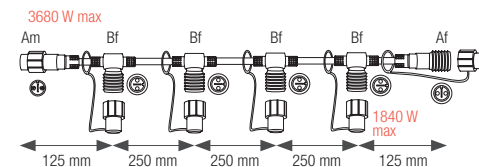

COLLECTOR CABLE 6 FALLS

REFERENCE	CABLE LGT.
059241	0.80 m
059240	0.80 m

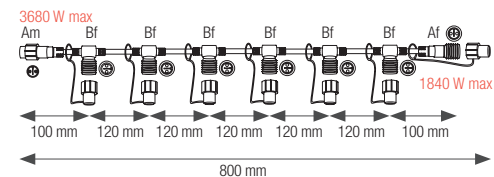

COLLECTOR CABLE 10 FALLS

REFERENCE	CABLE LGT.
032356	10 m
032357	10 m

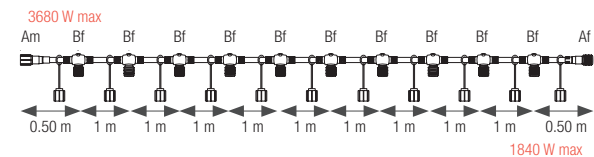

Plug & Light 24V: what makes it special?

To connect your P&L 24V decorations safely, please follow these steps :

STEP 1 . Identify the lighting decorations you wish to use for your project.

STEP 2 . Check and carefully follow the maximum recommended length for each type of decoration.

STEP 3 . Add up the wattages of all selected decorations to determine the total wattage. Then use a suitable transformer

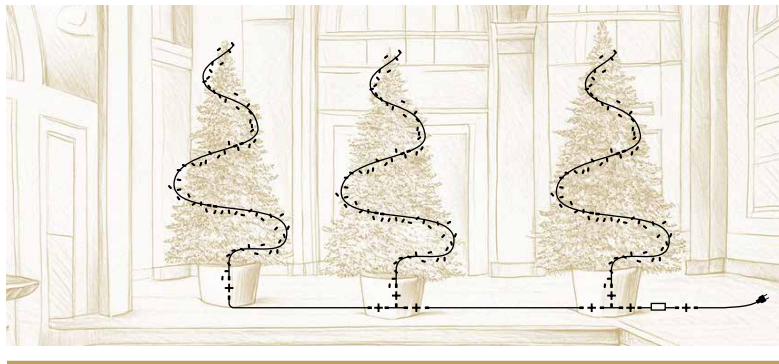

EXAMPLE OF **SERIES** AND **PARALLEL** WIRING

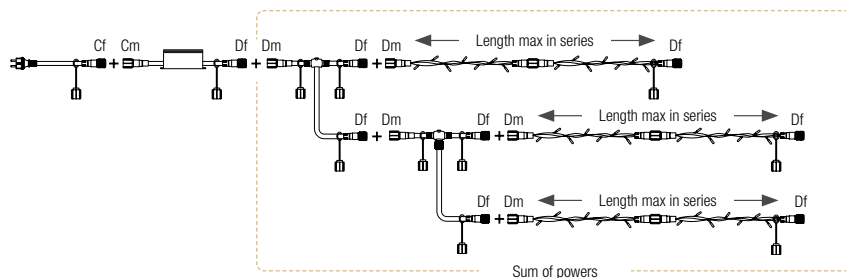

Decorate your storefront by combining P&L 24V and P&L 230V.

It's entirely possible to combine Plug & Light decorations operating on 24V with those on 230V.

For example, you can dress up a shop window with 24V microLED string lights, whose discreet power cable ensures an aesthetic installation, while using a 230V light decoration to decorate a Christmas tree.

These elements complement each other to create a magical atmosphere and draw visitors into a magical Christmas setting!



EXAMPLE OF MIXED **230V** AND **24V** WIRING

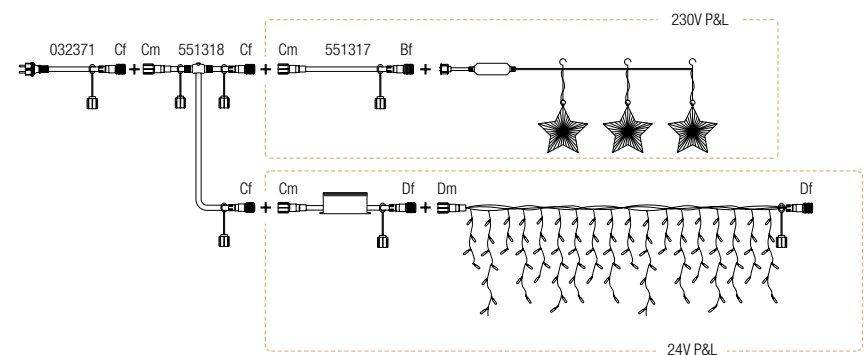

230V / 24V PLUG & LIGHT CONNECTORS

P&L
24V

CHROMEX

ACCESSORIES AHEAD 230V TRANSFORMER

REFERENCE DESCRIPTION LGT. CABLE P. MAX/ 230V

032371 Bipolar power supply cable + grounding 3 m 1840 W

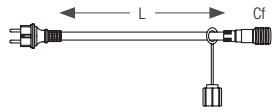

REFERENCE DESCRIPTION LGT. CABLE P. MAX/ 230V

032372 Bipolar extension cable + grounding 2 m 1840 W

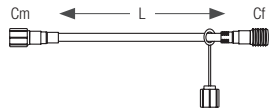

REFERENCE DESCRIPTION LGT. CABLE P. MAX/ 230V

551317* Connector adapter C to B 15 cm 1840 W

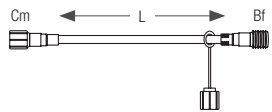

REFERENCE DESCRIPTION LGT. CABLE P. MAX/ 230V

032373 Bipolar T-connector + grounding 50 cm 1840 W

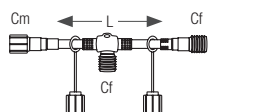

REFERENCE DESCRIPTION LGT. CABLE P. MAX/ 230V

551318* Bipolar T-connector + grounding 50 cm 1840 W

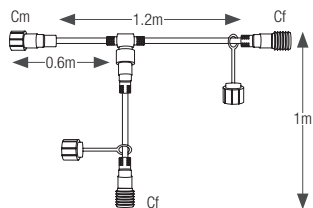

This reference is ideal for powering both 24V and 230V decorations.

TRANSFORMERS 230V AC / 24V DC

REFERENCE DESCRIPTION

550514 Transformer 0.5 A max. (12W/24VDC) output

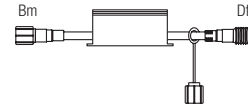

Works in AC or DC.
B connector input.

This reference is ideal for powering our 24V P&L suspensions.

REF. DESCRIPTION

061218 Transformer 1.25 A max. (30W/24VDC) output

061219 Transformer 2.5 A max. (60W/24VDC) output

061220 Transformer 4 A max. (96W/24VDC) output

550628 Transformer 6.25 A max. (150W/24VDC) output

550336 Transformer 2x 6.25 A max. (2x150W/24VDC) output

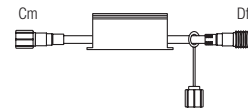

ACCESSORIES BEYOND TRANSFORMER

REFERENCE DESCRIPTION LGT. CABLE

032367 T-connector 25 cm

550471 T-connector 25 cm

300043* T-connector 25 cm

300044* T-connector 25 cm

300045* T-connector 25 cm

550931 Titan⁽¹⁾ T-connector 25 cm

⁽¹⁾ Products with rubber cable.

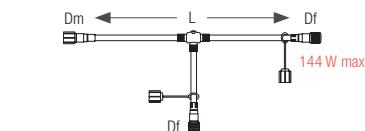

ACCESSORIES BEYOND TRANSFORMER

REFERENCE DESCRIPTION LGT. CABLE

032366 Extension cable 1 m

550470 Extension cable 1 m

300040* Extension cable 1 m

300041* Extension cable 1 m

300042* Extension cable 1 m

550244 Extension cable 2 m

550930 Titan⁽¹⁾ ext. cable 2 m

550342 Extension cable 10 m

⁽¹⁾ Products with rubber cable.

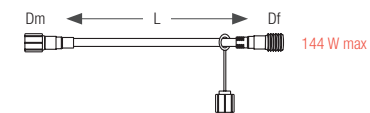

REFERENCE DESCRIPTION LGT. CABLE

032365 Rope light to garland connection 30 cm

300049* Rope light to garland connection 30 cm

300046* Rope light to garland connection 30 cm

300047* Rope light to garland connection 30 cm

300048* Rope light to garland connection 30 cm

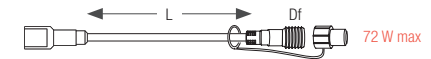

REFERENCE DESCRIPTION LGT. CABLE

032364 Garland to rope light connection 30 cm

300053* Garland to rope light connection 30 cm

300050* Garland to rope light connection 30 cm

300051* Garland to rope light connection 30 cm

300052* Garland to rope light connection 30 cm



REFERENCE DESCRIPTION LGT. CABLE

032368 Connector 6 falls 1 m

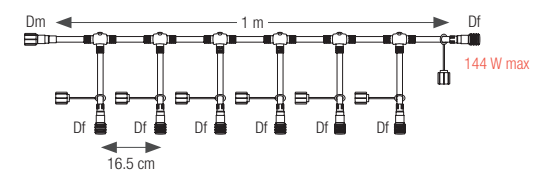

DAY TIME DECORATIONS

e-deco



PRINTED PRODUCTS ACROSS STREET AND LAMP COLUMNS



Made in France, our 3D printed products are 100% recyclable. The material will be transformed into new granules for creating new decorations.

Integrate day-visible decorations into your illuminations. Design by Leblanc Illuminations. UV resistant. Suitable for use in buildings not subject to regulations for public-access buildings.



For more information on our 3D printing process, see e-deco by Leblanc Illuminations, page 5.

Collections of 2D decorations.

Attachment points included. Non-luminous decorations. Available individually. The Lyria collection is available in red, white or gold. The Givre collection is available in white or gold. The Holly collection is available in green or gold.

REFERENCE	DESCRIPTION	DIMENSIONS	MATERIAL
170703	Lyria across street red	H 1.50 x W 5 m	Rainbow
170702	Lyria candélabre red	H 3 x W 1.40 m	Rainbow
170701	Lyria candélabre red	H 2 x W 1.40 m	Rainbow
170786	Givre across street white	H 1 x W 5 m	Rainbow
170785	Givre lamp col. & across str. white	H 3 x W 1.45 m	Rainbow
170784	Givre lamp col. & across str. white	H 2.50 x W 1.20 m	Rainbow
170783	Givre lamp col. & across str. white	H 2 x W 1 m	Rainbow
170782	Givre lamp col. & across str. white	H 1.50 x W 0.75 m	Rainbow
170781	Givre lamp col. & across str. white	H 1 x W 0.50 m	Rainbow
170787	Givre globe white	H 2 x W 1.20 m	Rainbow
170788	Givre suspension white	H 0.80 x W 0.80 m	Rainbow
170809	Holly across street green	H 1 x W 5 m	Rainbow
170808	Holly lamp col. & across str. green	H 3 x W 1.45 m	Rainbow
170807	Holly lamp col. & across str. green	H 2.50 x W 1.20 m	Rainbow
170806	Holly lamp col. & across str. green	H 2 x W 1 m	Rainbow
170805	Holly lamp col. & across str. green	H 1.50 x W 0.75 m	Rainbow
170804	Holly lamp col. & across str. green	H 1 x W 0.50 m	Rainbow
170810	Holly globe green	H 2 x W 1.20 m	Rainbow
170811	Holly suspension green	H 0.80 x W 0.80 m	Rainbow



PRINTED PRODUCTS FLOORSTANDING 3D DECORS

3D floorstanding decorations. Delivered flat.

Attachment points included. Non-luminous decorations. Available individually. Four colours are available: gold, white, blue or red.

REFERENCE	DESCRIPTION	DIMENSIONS	MATERIAL
170738	Cadeau gold	W 0.3 x H 0.43 x D 0.3 m	Mellow
170655	Renne POP gold	W 0.72 x H 1.27 x D 0.37 m	Rainbow
170658	Sapin POP gold	W 0.81 x H 1.52 x D 0.81 m	Rainbow
170662	Barrière POP gold	W 0.7 x H 0.6 x D 0.3 m	Rainbow
170282	Maxi Cadeau Pop gold	H 0.50 x Ø 0.48 m	Rainbow
170278	Petit Cadeau Pop gold	H 0.50 x Ø 0.30 m	Rainbow
170286	Étoile Pop gold	H 0.64 x Ø 0.64 m	Rainbow

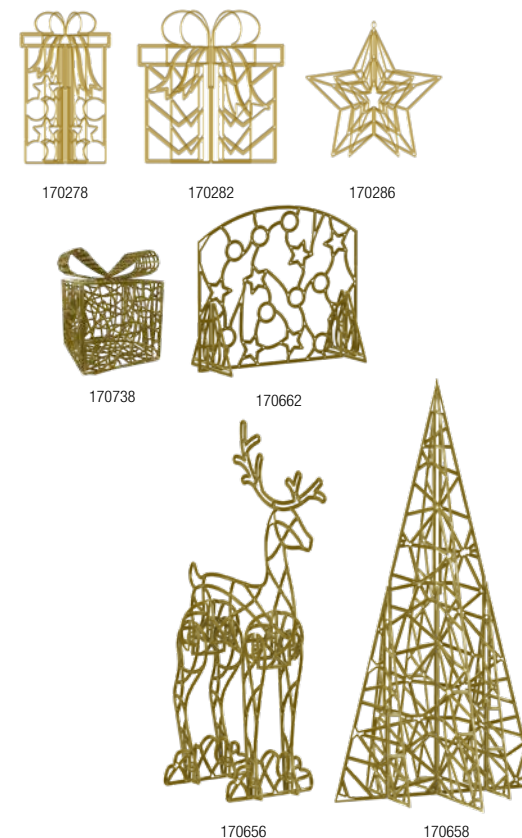

PRINTED PRODUCTS LUMINOUS 3D SUSPENSIONS

Snowfall effect droplight. Lighting decorations to hang. Delivered flat.

Attachment points included. Available individually. Four colours are available: gold, white, blue or red. Find our droplights p.232.

REFERENCE	DESCRIPTION	DIMENSIONS	MATERIAL
205313	Magie gold	H 0.50 x Ø 0.10 m	Mellow
204988	Boule de Noël Pop gold	H 0.50 x Ø 0.37 m	Rainbow
204992	Boule Tradi Pop gold	H 0.50 x Ø 0.39 m	Rainbow
204996	Maxi Cadeau Pop gold	H 0.50 x Ø 0.48 m	Rainbow
205001	Petit Cadeau Pop gold	H 0.50 x Ø 0.30 m	Rainbow
205005	Flocon Étoile Pop gold	H 0.50 x Ø 0.46 m	Rainbow
205009	Flocon Givré Pop gold	H 0.50 x Ø 0.50 m	Rainbow
205013	Étoile Pop gold	H 0.64 x Ø 0.64 m	Rainbow
205017	Éclat Pop gold	H 0.54 x Ø 0.52 m	Rainbow

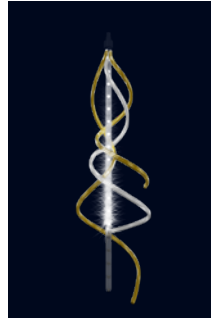

205313



204988



204992



204996



205001



205005



205009



205013



205017

PRINTED PRODUCTS 3D SUSPENSIONS

3D floorstanding decorations. Delivered flat.

Attachment points included. Non-luminous decoration. Available individually. Four colours are available: gold, white, blue or red.

REFERENCE	DESCRIPTION	DIMENSIONS	MATERIAL
170721	Lanterne POP gold	W 0.27 x H 0.5 x D 0.27 m	Rainbow
170723	Perle	W 0.3 x H 0.6 x D 0.3 m	Mellow
170727	Goutte	W 0.35 x H 0.6 x D 0.12 m	Mellow
170838	Moulin	W 0.65 x H 0.65 m	Mellow
170833	Nœud	W 0.57 x H 0.54 m	Mellow



170721

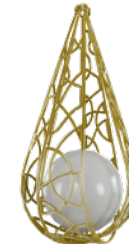

170723



170727

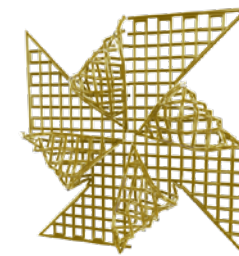

170838



170833

PRINTED PRODUCTS 2D SUSPENSIONS



170304



170340



170292



170320



170300



170328



170288



170312



170308



170332



170296



170316



170336



170324



170344



170348

2D suspensions.

Attachment points included. Non-luminous decoration. Sold in packs of 5, except for ref.170336. Four colours are available: gold, white, blue or red.

REFERENCE	DESCRIPTION	DIMENSIONS	MATERIAL
170304	Cadeau Étoiles gold	W 38.7 x H 65.8 cm	Rainbow
170300	Cadeau Dream gold	W 52.8 x H 42.8 cm	Rainbow
170308	Cadeau Zig gold	W 38.7 x H 40.7 cm	Rainbow
170292	Boule de Noël gold	W 32.7 x H 45.4 cm	Rainbow
170288	Boule Tradi gold	W 31.2 x H 40.7 cm	Rainbow
170296	Petite Boule gold	W 21.3 x H 16 cm	Rainbow
170340	Flocon Givré gold	W 39.7 x H 39.7 cm	Rainbow
170328	Flocon Étoile gold	W 21.7 x H 31.7 cm	Rainbow
170332	Petit Flocon gold	W 18.5 x H 21.3 cm	Rainbow
170320	Éclat gold	W 40.7 x H 31.3 cm	Rainbow
170312	Grande Étoile gold	W 38.7 x H 40.7 cm	Rainbow
170316	Petite Étoile gold	W 19.7 x H 20.7 cm	Rainbow
170324	Flocon Snow gold	W 36.2 x H 40.7 cm	Rainbow
170344	Pain d'Épices gold	W 33.5 x H 40.6 cm	Rainbow
170348	Sucre d'Orge gold	W 21.8 x H 30 cm	Rainbow
170336	Flocon Baroque gold	W 95.2 x H 83 cm	Rainbow

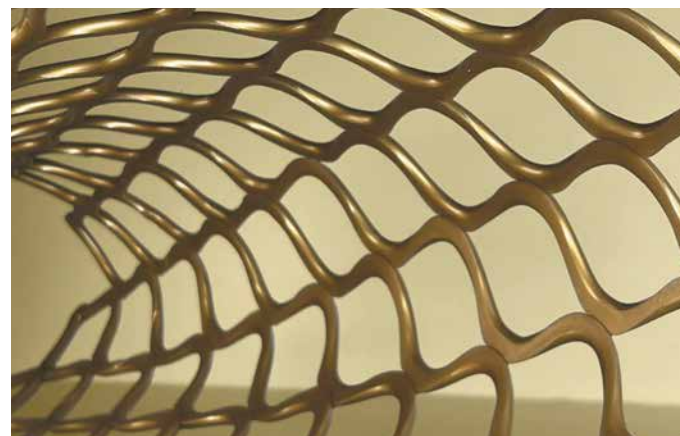

DAY TIME DECORATIONS



INFLATABLE SHINING BAUBLES

REFERENCE	DIAMETER	COLOUR
550101	40 cm	Grey
550100	40 cm	Gold
550102	40 cm	Red
550103	40 cm	Green

Inflatable structure covered with fabric.

Suitable for use in buildings not subject to regulations governing buildings receiving the public. Compressor required.

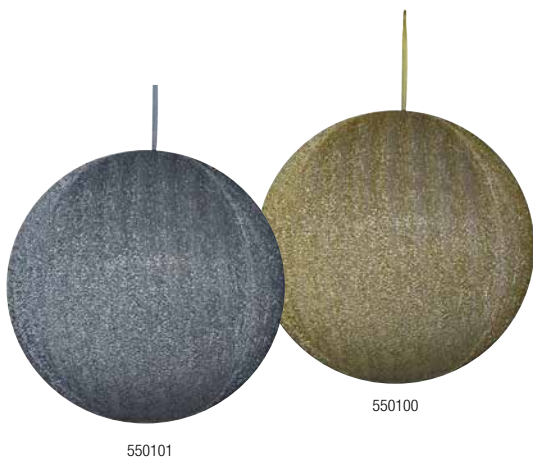

FOLDABLE SHINING STARS

REFERENCE	DIAMETER	COLOUR
550093	80 cm	Grey
550092	80 cm	Gold
550094	80 cm	Red
550095	80 cm	Green
550097	150 cm	Grey
550096	150 cm	Gold
550098	150 cm	Red
550099	150 cm	Green

Foldable decoration.

Metal structure covered with fabric. Suitable for use in buildings not subject to public access regulations.

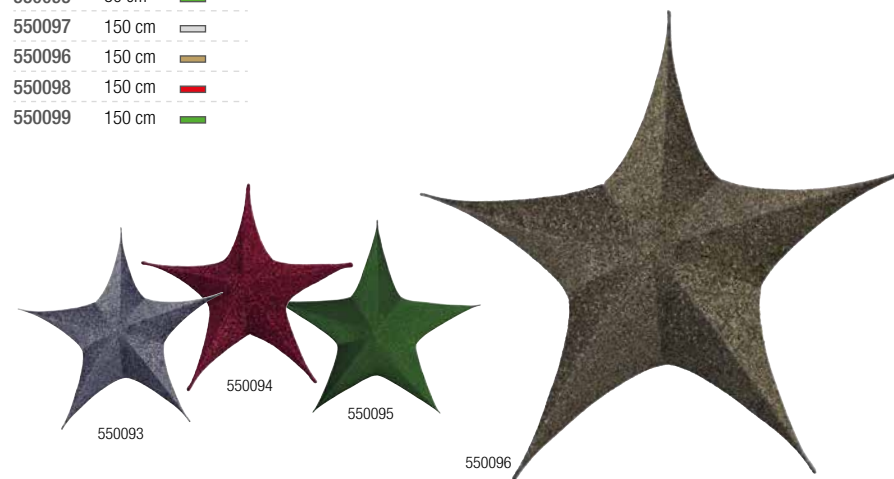

CHRISTMAS KNOTS

REFERENCE	DESCRIPTION	DIMENSIONS AXBXC
550938	Red & gold Xmas knot	38 x 45 x 10 cm
550939	Red & gold Xmas knot	60 x 76 x 17 cm
550940	Red & gold Xmas knot	91 x 114 x 23 cm
550941	Red Xmas knot	30 x 38 x 7.5 cm
550942	Red Xmas knot	45 x 58 x 15 cm

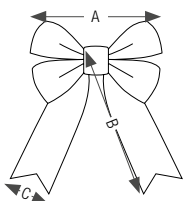

Extremely resistant for outdoor use.

Wire fastening on the back. Suitable for use in buildings not subject to regulations governing buildings receiving the public.



FOLDABLE LANTERNS

REFERENCE	DIMENSIONS	COLOUR
550488	Ø 25 cm	Yellow
550489	Ø 25 cm	Orange
550490	Ø 25 cm	Red
550491	Ø 25 cm	Green
550492	Ø 25 cm	Blue
550493	Ø 25 cm	Pink
550494	Ø 25 cm	White
550572	Ø 25 cm	Red, Yellow, Blue, Green, White
550949	Ø 15 x H 25 cm	White



550491



550949

Foldable decoration. Volume effect, flat storage.

Sold in sets of 5.

Metal structure covered with fabric. Suitable for use in buildings not subject to regulations governing buildings receiving the public.

UV resistant. Designed to be assembled on suspension sockets ref.550180, or B22/E27 garlands.

Ref.550572: 1 red, 1 yellow, 1 blue, 1 green and 1 white lantern.



FIBERGLASS DECORATIONS

REFERENCE	DESCRIPTION	DIAMETER	HEIGHT	FIBER
050174	Half-sphere	50 cm	25 cm	☐
050172	Half-sphere	50 cm	25 cm	■
050176	Half-sphere	100 cm	50 cm	☐
050177	Half-sphere	100 cm	50 cm	■
050683	3D pot	100 cm	100 cm	☐
050180	Cone	60 cm	120 cm	☐
050182	Cone	115 cm	250 cm	☐
050184	Ribbon	50 cm	150 cm	☐

Can be decorated with garlands or illuminated with a projector.

Visible in daylight and easy to highlight at night. Light and strong structures. Available in different sizes.

These products are suitable for use in public access building-regulated buildings as they are non-combustible.



050683



050174

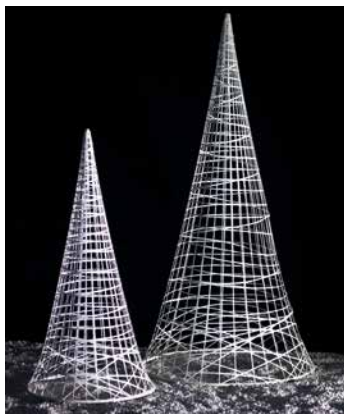

050180



050184



RIFLETTI SUSPENSIONS

REFERENCE	DESCRIPTION	DIAMETER
051066	Golden Rifletti mini star	280 mm
051067	Golden Rifletti disc	500 mm
051069	Silver Rifletti disc	500 mm



Swivel hook



Delivered flat. Swivelling in the wind.

Gold or silver stainless steel suspensions. Delivered flat. Swivel hook included. Mini stars packed by 5. Stars and discs available individually.



051069



051067



051066

VOLUME JABOTS

REFERENCE	LGT.	DIAMETER	WEIGHT
051016	2.70 m	14 to 35 cm	2 kg
051076	4 m	14 to 50 cm	6 kg

Natural effect.

Supplied with 2 alpine karabiners. Flexible and luxuriant.



CHRISTMAS BALLS

DIAMETER	PEARL	SILVER	GOLD	BLUE	RED	PINK
100 mm	060742	060743	061052	001814	061024	061020
140 mm	060820	060759	060812	001813	060808	061030
200 mm	060821	060745	060813	060856	060809	061061
280 mm	060822	060817	061056	060857	000002	061107
400 mm	060823	060818	060814	001242	060810	060980



Outdoor drilled balls (from Ø 200 mm). Attachment included. Glossy finish (except from pearly). Choose your diameter.

WITH MIRROR EFFECT SUSPENSIONS

REFERENCE	DESCRIPTION	DIAMETER
050562	Mirror flakes	26 cm
050563	Mirror sparkles	25 cm

Reflects light.

Mirrored surfaces on both sides. 2 attachment points. Suitable for use in buildings not subject to regulations governing buildings receiving the public. Packed by 10.

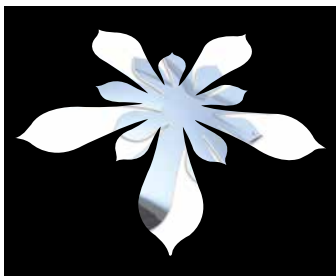

050562

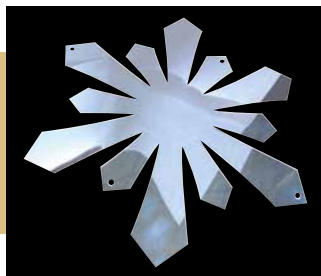

050563

ROUNDED SPANGLES

DIAMETER	SET OF	WHITE	GOLD	BLUE	RED
100 mm	10	600439	600434	600449	600444
140 mm	10	600440	600435	600450	600445
200 mm	5	600441	600436	600451	600446
280 mm	5	600442	600437	600452	600447
400 mm	4	600443	600438	600453	600448



600449

Beautiful glitter effect on both sides.

Sold in lots.



600439

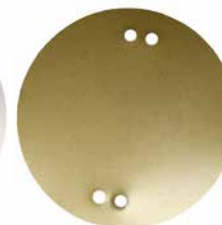

600434

SPANGLES

REFERENCE	DESCRIPTION	DIAMETER
050772	Silver and gold spangles	10 cm

Gold on the front, silver on the back.

Packed by 10.

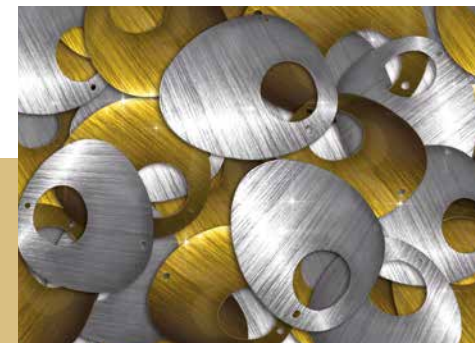

FEATHERS AND LEAVES

REFERENCE	DESCRIPTION	DIMENSIONS
600428	Little silver feather	43 x 8 cm
600429	Little golden feather	43 x 8 cm
600430	Silver leaves	36 x 20 cm
600431	Golden leaves	36 x 20 cm
600432	Width silver feather	50 x 12 cm
600433	Width golden feather	50 x 12 cm

A touch of nature and delicacy...

Integrate decoration visible during the day into your illuminations. Suitable for use in buildings not subject to regulations governing buildings receiving the public. Packed by 12.

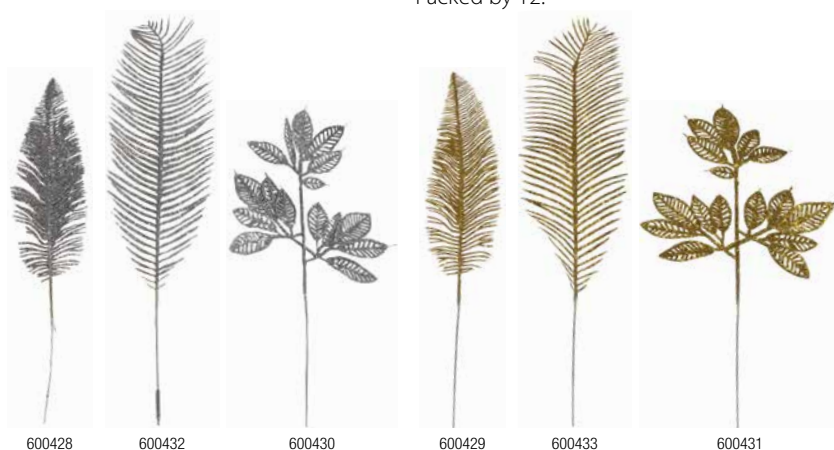

GARLANDS WITH SPANGLES

REFERENCE	DESCRIPTION	LGT.
060790	Garland with silver spangles	20 m
060791	Garland with golden spangles	20 m
060792	Garlands with blue spangles	20 m
060793	Garland with red spangles	20 m
550386	Garlands with pink spangles	20 m

Reflects light.

Reflective coloured spangles. Visible day and night.



060791



060793

DECORATIVE GARLANDS

REFERENCE	DESCRIPTION	LGT.
050579	Brilliant glass beads	10 m

Reflections, sequins, splinters ...

Integrate decoration visible during the day into your illuminations. Suitable for use in buildings not subject to regulations governing buildings receiving the public.



050579

NATURAL CHRISTMAS TREES



Choose a tailor-made giant natural Christmas tree and support European Christmas tree growers.

This innovative metal structure brings together lots of standard-sized natural fir trees, to form an impressive festive centrepiece. Validated by technical consultants, the resulting structure stands up to the most extreme weather conditions and can be safely installed in a public place.

The spruce or Nordmann fir Christmas trees used to form this giant tree, have been grown in special forests in France. The giant tree can be created in your desired height and includes full installation kit: metal structure, Christmas trees, ballast and bracing kit, screws and assembly drawing.



TECHNOLOGICAL
ANIMATIONS



LOOMIE TECHNOLOGY



Try an immersive enhanced-reality experience in the town or city-centre!

Visitors can interact with the illuminations and their environment. Create traffic and energize the city center!

Loomie is a seasonal augmented reality app for smartphones (Android and IOS), downloadable from App Store and Play Store. It works within a specific area, defined for your event. Thanks to a QR code sign (provided by Leblanc illuminations), visitors are invited to download the app to access a variety of interactive 3D games to play within the heart of your city.



Discover Loomie

The aim of this app: create a buzz about your place, while inviting visitors to share pictures featuring your logo to their friends and family!

Thanks to its simplicity and in-built shareability, the app encourages social sharing featuring your logo, via the internet and social networks (facebook, instagram, snapchat, etc...).



- 1 Activate geolocation
- 2 Start application
- 3 Play and share

Download Loomie



5 applications



This is primary function of the application. Also available at the end of each game, it allows you to create personalised digital greeting cards in a matter of seconds.



Father Leon hires Detective Rudolph to go in search of the objects that make the Christmas Spirit. A real treasure hunt in your city!



The wind scattered Pigloo's clothes while he was taking his bath. In this game, the user must find them by scanning the environment with the screen.



In this race against the clock, you have to help Father Leon catch a maximum of gifts that have fallen from the sky by moving him around the screen.



Even more visibility and traffic! This function sends the user directly to your website.

A turnkey offer including:

- 1 Freestanding totem pole ref. 300006.
- 3 games for young and old: Pigloo, the chilly penguin, Father Leon, the gift catcher and Detective Rudolph - Let's save Christmas!
- Personalization of the digital greeting cards with your logo, as well as 8 fun photo filters.
- redirection link to your website.
- The different graphic elements in your city's promotional materials.



PLAY
with Augmented Reality



CUSTOMIZE
your photos using postcard type filters and add a text



TAKE YOU SELFIES
next virtual characters



SHARE
your picture



REFERENCE	DESCRIPTION
LOOMIE	Loomie app. + Freestanding totem pole
300006	Freestanding totem pole with Loomie plate with QR Code
300007	Loomie plate with QR Code

REMOTE CONTROL SOLUTION OF YOUR ILLUMINATIONS

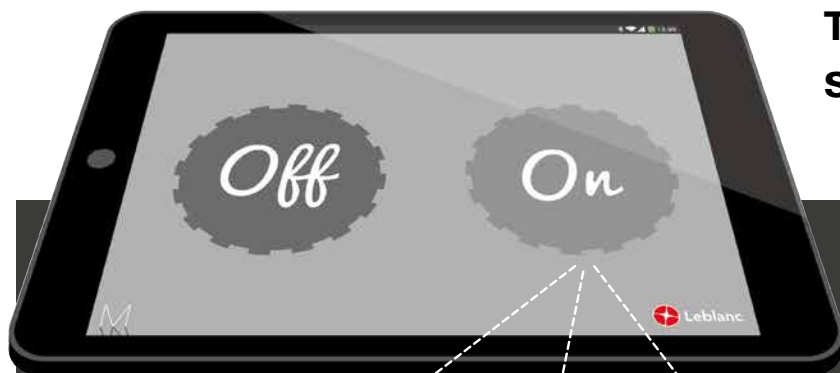

Technology designed to
save energy.

Nearly **50%**
energy saving
with our patented solution!

I can programme my illuminations and their
turned on/off period and hours, zone by zone,
with a few clics on my tablet or smartphone.

It's so easy. I don't need any extra power supply
cable.

Indeed, with the Saver Box installed on Leblanc
illuminations products, I simply **download the App**
and let myself be led.

Further information
on our remote control solution



REMOTE CONTROL SOLUTION OF YOUR ILLUMINATIONS

Simple and intuitive

- Intuitive app
- Wireless communication (Bluetooth / 868 MHz)
- One power cut period and 4 exceptions
- Memorising of programmes guaranteed even switched off
- Super-easy installation thanks to the Plug & Light connectors

PASS BOX ⁽¹⁾

REFERENCE	REACH	AUTONOMY
010020	50 m	7 hours



Communication link between decoration and tablet/ smartphone.

Controls and programs the street decorations equipped with a Saver Box, thanks to the App, the tablet/smartphone application.

- Dimensions: H 117 x W 72 x P27 mm
- Wireless radio / bluetooth communication
- Bluetooth reach to the 1st Saver Box is 50 m maxi.
- 7 hours battery life - supplied with battery, mains charger 230V, and mini USB cable.
- IP 20

Accessories to avoid cutting the Maestro housing connector :

MALE CONNECTOR WITH CABLE GLAND

REFERENCE	CABLE	LGT.
032355	—	0.18 m

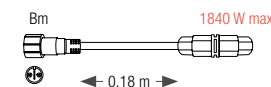

FEMALE CONNECTOR WITH CABLE GLAND

REFERENCE	CABLE	LGT.
032369	—	0.18 m

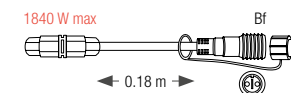

P&L
230V

SAVER BOX ⁽¹⁾

REFERENCE	REACH	P. MAX/230V
010019PA	50 m	460W/AC + 460W/DC



Power supply which turns on/off street decorations according to required hours.

Enables you to create a power cut period at night. The Savers Boxes talk to each others wireless.

- Dimensions: H 115 x W 78 x D 33 mm
- Power supply 230V AC
- 1 AC max 2A output + 1 DC max 2A output, P&L Bf
- Connection 2.35 mm P&L Bm
- IP 54

⁽¹⁾ Works in Europe only

KUBIX³ TECHNOLOGY

Produce
amazing
light shows
with Kubix³ !

Kubix3, an exclusive Leblanc illuminations technology.

These DMX transmission boxes let you control, dim and synchronise very precisely all our street decorations, lighting solutions, projectors, let you set up independant networks and make the most amazing light designs possible.



Discover Kubix³



Saint Jean de Luz • France



Pau • France



Megève • France

230V

P&L
230V IP67

REFERENCE	DESCRIPTION	C. DMX
110004	Kubix ³ 230V	1/3

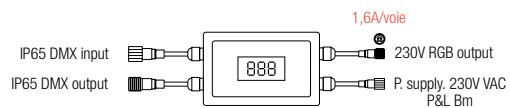

Front side adressable DMX controller.

Stand alone mode with preset programmes for non DMX use.

- Dimensions : W 170 x l 73,6 x D 38 mm

ADAPTER 3 WAYS / P&L

REFERENCE	LGT.
300009	40 cm

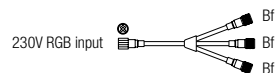

DMX ACCESSORIES

REFERENCE	DESCRIPTION	DIMENSIONS	WEIGHT	C. DMX
180034	E-Board 512	97 x 166 x 38 mm	0.18 kg	1 x 512

REFERENCE	DESCRIPTION	LGT.
080805	Adapter DMX in/outdoor	20 cm
080190	IP 67 DMX cable light	10 m
080191	IP 67 DMX cable light	5 m
080192	IP 67 DMX cable light	2.50 m

Example of 230V cabling plan

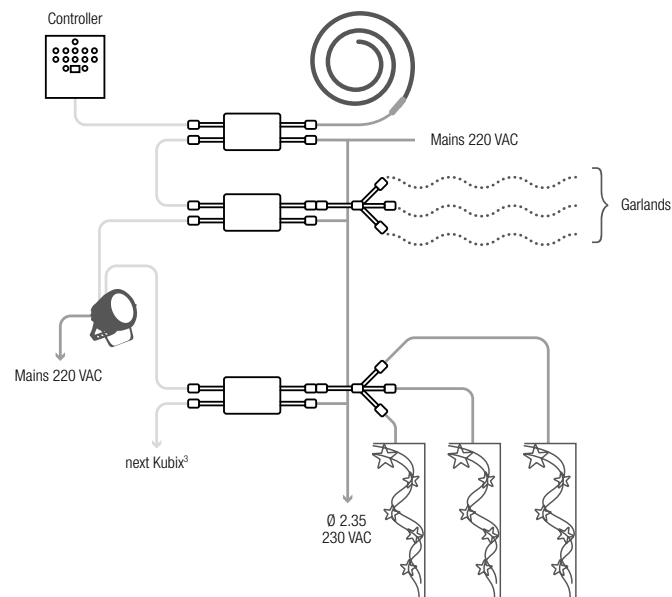

HALTO

by Leblanc illuminations

**HALTO, exclusively from
LEBLANC illuminations.**

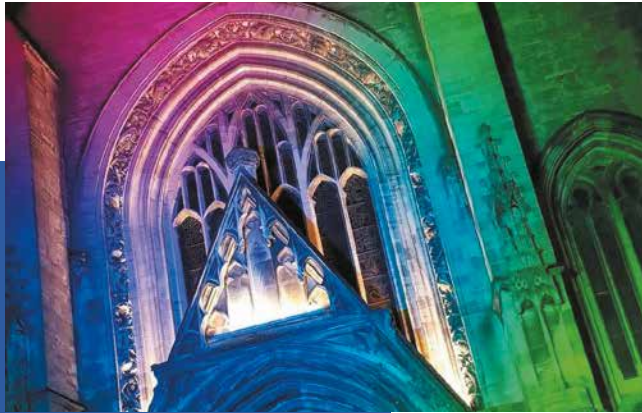

The dynamic highlight

For more than 30 years, the HALTO brand has dedicated its work to lighting designers, visual artists, scenographers, and event agencies.

With its experience, HALTO provides tailor-made lighting solutions—designed specifically for you!

Whether it's for use in aquatic, urban, dynamic environments or extreme cold conditions... HALTO will turn your creative ideas into exceptional achievements!

www.halto.fr



Discover the
HALTO catalogue

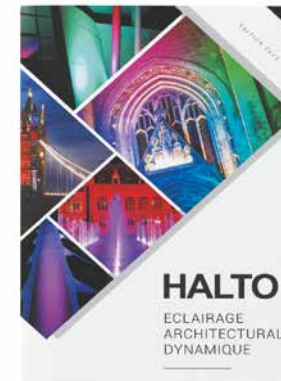



Architectural Lighting



BAR

IP67 **NEW**

REFERENCE	DESIGNATION LAMP		DIMENSIONS	WEIGHT P. / 230V	OPTICS	C. DMX
180240*	BAR 9	RGBL 9 LED	305 x 66 x 61 mm	1.2 kg 30 W	15° to 60°	1/3/4/5/6/7
180241*	BAR 18	RGBL 18 LED	610 x 66 x 61 mm	2.2 kg 60 W	15° to 60°	1/3/4/5/6/7/11
180242*	BAR 27	RGBL 27 LED	915 x 66 x 61 mm	3.3 kg 90 W	15° to 60°	1/3/4/5/6/7/15



New generation of linear wall washers, the BAR series exists in 3 versions, with 9, 18, or 27 LEDs. The IP67 Bars are designed as a flexible solution to highlight a wide variety of outdoor building structures. The Bars are equipped with the RDM function and can be controlled by sections (Bar 9 – 1 section, Bar 18 – 2 sections, Bar 27 – 3 sections). Each section requires 1 filter (for example: 1 filter for Bar 9, 2 filters for Bar 18, and 3 filters for Bar 27).
Finish : saline treatment.

- 9, 18 ou 27 LEDs multichip RGBL
- Beam angle 15° to 60°
(15°, 30°, 45°, 60°, 15°x30° et 15°x60°)
- RDM
- IP67



SPO 15

- 1 RGLB LEDs
- Power 15W



SPO 100

- 5 RGLB LEDs
- Power 100W



SPO 180

- 9 RGLB LEDs
- Power 180W



SPO 450

- 30 RGLB LEDs
- Power 450W



SPO & SQA 300 use the latest 4 in 1 LED technology to get the highest color saturation and exceptional color mixing. The different filters provide several beam angles for the best expected effect. Thanks to the RDM function, the projectors instantly give feedback about their working condition, which simplifies the set-up operations. Finish : saline treatment.

- RGLB LEDs
- Beam angle 6°
- Advanced color processing
- RDM
- IP67



SQA 300

- 27 RGLB LEDs
- Power 300W



REFERENCE	DESIGNATION	LAMP	DIMENSIONS	WEIGHT	P. / 230V	OPTICS	C. DMX
180247	SPO 450	RGLB 30 LED	423 x 284 x 443 mm	18 kg	450 W	6°	1/3/4/5/7/15
180243*	SQA 300	RGLB 27 LED	521 x 119 x 284 mm	11.4 kg	300 W	6°	1/3/4/5/7/8
180246	SPO 180	RGLB 9 LED	287 x 245 x 284 mm	8 kg	180 W	6°	1/3/4/5/7/8
180245	SPO 100	RGLB 5 LED	206 x 197 x 217 mm	5 kg	100 W	6°	1/3/4/5/7/8
180244	SPO 15	RGLB 1 LED	176 x 111 x 164 mm	1.7 kg	15 W	6°	1/3/4/5/7/8

GOBO SELECTION



800259



800042



800000

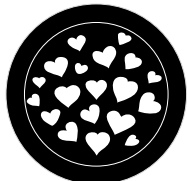

800519



800278



800283



800202



800564



800038

CUSTOMISED GOBOS

On request, we can produce your personalized visual.



NEWTON 210 HD+

IP66

REFERENCE	DESIGNATION	LAMP	DIMENSIONS	WEIGHT P. / 230V	OPTICS	C. DMX
180063	Newton 210 HD+	RGBAL LED	668 x 344 x 273 mm	16 kg	250 W 15° > 30°	8/10/13/19

The Newton 210 HD+ is an IP66 profile projector equipped with a 250W RGBA + Lime LED and a medium-sized gobo holder (water effect gobo included). The light features 12 white macros, ranging from 2700° to 8000°, as well as Lee and Rosco color presets. The light body is made of die-cast aluminum and is resistant to temperatures from -20°C to +45°C.



- IP66 profile
- Zoom 15 to 30°
- Motorized zoom focus
- 4 manual shutters
- Medium size indexable rotating gobo
- Water effect gobo included
- Wireless DMX by Wireless Solution
- RDM
- Illuminance 4662 Lux at 5m in 15°



Watch the animations

KEPLER 350

The Kepler 350 is an IP66 gobo projector equipped with a 350W white LED at 7000°—perfect for outdoor projection. Thanks to its various gobo effects, CMY, prism, frost, and an 8° to 40° zoom, the spotlight delivers impressive short and long-distance projections. With an IP66 waterproof rating, the product is ideal for use in theme parks, shopping centers, architectural buildings, historical monuments, and more.

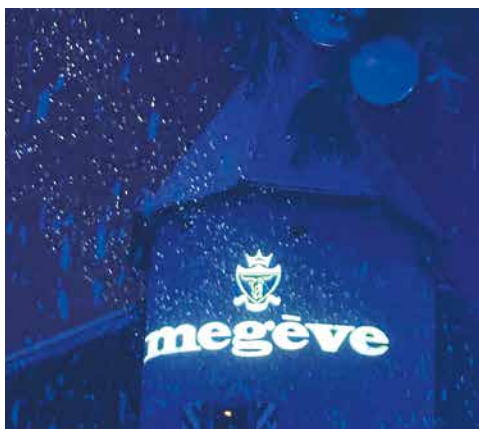

- 350W white LED
- Zoom 8 to 40°
- Power 380W
- 7 rotating gobos + white wheel
- 7 colors + white wheel
- CMY
- Animation wheel
- 3 facets prism
- Frost
- Wireless Solution
- RDM
- IP66



KEPLER 150

IP66

REFERENCE	DESIGNATION	LAMP	DIMENSIONS	WEIGHT P. / 230V	OPTICS	C. DMX
180249	Kepler 350	□ White 1 LED 350 W	605 x 343 x 250 mm	23 kg 350 W	8° > 40°	17/20
180248	Kepler 150	□ White 1 LED 150 W	454 x 201 x 186 mm	9.2 kg 150 W	18° > 40°	11/14

The latest addition to the range, the Kepler 150, is an IP66 gobo projector equipped with a 100W 5900K white LED engine, delivering a flux of 2850 lumens. Housed in a compact case, it includes a 5-color wheel, a 4-rotating-gobo wheel, a 4-facet prism, an animation wheel, and an 18° to 40° zoom. The Kepler 150 can project images onto buildings or any other outdoor surface at short or medium distances. It is also equipped with a wireless DMX receiver, eliminating the need for a control cable.

- 100W white LED
- Zoom 18 to 40°
- Power 150W
- 4 rotating gobos
- 5 colors wheel
- CMY
- Animation wheel
- 4 facets prism
- Wireless Solution
- RDM
- IP66

ACCESSORIES

FILTERS

REFERENCE	DESIGNATION
180234*	Filter 20° for SQA 300
180233*	Filter 40° for SQA 300
180232*	Filter 55° for SQA 300
180231*	Filter 60° x 10° for SQA 300
180170	Filter 20° for SPO 450
180171	Filter 40° for SPO 450
180172	Filter 55° for SPO 450
180173	Filter 60° x 10° for SPO 450
180165	Filter 20° for SPO 180
180166	Filter 40° for SPO 180
180167	Filter 55° for SPO 180
180168	Filter 60° x 10° for SPO 180
180111	Filter 20° for SPO 100
180112	Filter 40° for SPO 100
180113	Filter 55° pour SPO 100
180114	Filter 60° x 10° pour SPO 100
180179	Filter 10° for SPO 15
180180	Filter 30° for SPO 15
180181	Filter 40° for SPO 15
180182	Filter 60° for SPO 15
180183	Filter 80° for SPO 15
180184	Filter 10° x 60° for SPO 15
180120	Frost filter 30° x 1° for BAR
180121	Frost filter 15° x 1° for BAR
180122	Frost filter 60° for BAR
180123	Frost filter 10° x 30° for BAR
180124	Frost filter 60° x 1° for BAR
180125	Frost filter 30° x 60° for BAR

Provide 2 Filters per BAR 18, and 3 Filters per BAR 27.

FILTER HOLDERS

REFERENCE	DESIGNATION
180235*	Filter holder for SQA 300
180115	Filter holder for SPO 100
180164	Filter holder for SPO 180
180169	Filter holder for SPO 450

BARNDOORS

REFERENCE	DESIGNATION
180236*	Anti-glare shield for SQA 300
180126	Barndoors for BAR 9
180138	Barndoors for BAR 18
180127	Barndoors for BAR 27



POWER BOX

REFERENCE	DESIGNATION
180215	DMX/240V 10A power box for BAR



SIGNAL AMPLIFIERS

REFERENCE	DESIGNATION
180190	IP66 Signal amplifier 1 in / 4 out
180189	IP66 Signal amplifier 1 in / 2 out



E-CODER

REFERENCE	DESIGNATION
080095	E-Coder to address and set-up



COMBO EXTENSION CABLES FOR BAR

REFERENCE	DESIGNATION
180211	Combo extension cables (DMX/240V) 2.5m
180213	Combo extension cables (DMX/240V) 5m
180212	Combo extension cables (DMX/240V) 10m

POWER EXTENSION CABLES FOR KEPLER 350 / NEWTON 210 HD+

REFERENCE	DESIGNATION
080065	IP67 power cable - 10m
080064	IP67 power cable - 5m
080063	IP67 power cable - 2.5m

SIGNAL EXTENSION CABLES FOR KEPLER 350 / NEWTON 210 HD+

REFERENCE	DESIGNATION
080190	IP67 signal cable - 10m
080191	IP67 signal cable - 5m
080192	IP67 signal cable - 2.5m



IZY 80

Rotating gobo spotlight



XMAS GOBOS

For IZY 80



FLOODLITE

This projector packs an RGBW COB LED into its compact size, surprising you with its 200W power and 60° beam angle.

Its weight and size make it easy to conceal.

IP65

REFERENCE	DESIGNATION	LAMP	DIMENSIONS	WEIGHT P. / 230V	OPTICS
551157	IZY 80	White 1 LED 80 W	266 x 182 x 105 mm	2.3 kg	92 W 32°
800360	Set of 6 Christmas gobos				
551221	Optics 20° for IZY 80				
551222	Optics 20° for IZY 80				

IP65

REFERENCE	DESIGNATION	LAMP	DIMENSIONS	WEIGHT P. / 230V	OPTICS	C. DMX
180108	Floodlite HD	RGB 1 LED 200 W	235 x 110 x 190 mm	3 kg	120 W 60°	4/7/10/11/15



E-BOARD

This box allows you to animate all your events and lighting decorations.

Available in 512 or 1024 DMX channels, it lets you recall your recorded scenes using the buttons on the front panel.



IP20

REFERENCE	DESIGNATION	DIMENSIONS	WEIGHT	C. DMX
180163	E-Board 1024 MKII	127 x 110 x 40 mm	0.18 kg	2 x 512
180034	E-Board 512	97 x 166 x 38 mm	0.18 kg	1 x 512

Facilitate your installations by removing cables, opt for wireless DMX!

These boxes can support 512 to 1024 DMX channels, and can be used as DMX transmitters, receivers or repeaters, all IP65.

CRMX



REFERENCE	DESCRIPTION
110024	CRMX Outdoor FX
110031	CRMX Outdoor RX

CRMX OUTDOOR FX

CRMX Outdoor FX is the ultimate wireless DMX and RDM product for any installation.

- DMX512 and RDM support
- Power over Ethernet support
- Ethernet or wired DMX input/output
- Up to 1000 meter link range
- 5 ms latency
- Automated Cognitive Coexistence
- Forward Error Correction
- IP67 classification
- Vandal proof casing

CRMX OUTDOOR RX

CRMX Outdoor RX is an IP67 outdoor receiver for one DMX universe being transmitted by a CRMX transmitter (indoor or outdoor).

- One universe supported
- DMX512 and RDM support
- Up to 1000 meter link range
- 5 ms latency
- Automated Cognitive Coexistence
- Forward Error Correction



GALILEO RX

Supported Protocols:

- DMX / RDM
- CRMX², CRMX Classic
- W-DMX G3/G4/G4S/G5
- Bluetooth 5.0

GALILEO



REFERENCE	DESCRIPTION
110039	Galileo RX
110040	Galileo TX

Galileo makes your next installation project easier than ever by providing reliable Wireless DMX in an install friendly form factor.

GALILEO TX

Supported Protocols:

- DMX / RDM
- CRMX Classic
- W-DMX G3/G4S
- Bluetooth 5.0

RF Characteristics:

- 2402-2480 MHz frequency
- 7 - 280 mW output power
- 5ms latency
- 128-bit encryption
- Forward Error Correction

Physical:

- DIN-rail 2 module width
- RP-SMA antenna connector
- 12-24 VDC/VAC pluggable screw terminal
- DMX/RDM 3 pin pluggable screw terminal

Approvals :

- CE, FCC, IC, NRTL (MET), KC, MIC, UKCA

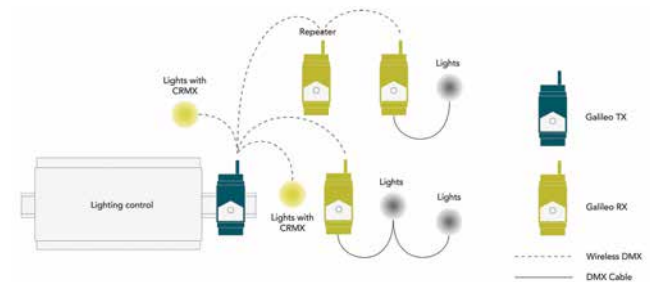



SERVICES

To support you in your projects, we offer a range of services.

From cable preparation to the installation start-up, everything will be done to guide you in the best possible way in the realization of your lighting

MEL-CABLAGE :

- Action carried out on a projector to match the product's connectors to the customer's project
- Address projector / Define static programme

MEL-PREPA :

- Project wiring plan
- Programming of a show defined with the customer
- Hotline with dedicated spotlighting contact person

MEL-ASSIST :

- On-site travel
- Project wiring plan
- Programming a show defined with the customer
- Helpline with dedicated contact person for spotlighting
- Adjusting spotlights and checking installation
- Validation of product operation

MEL-FORMA :

- On-site training 4 people maximum per course
- Training in projector use
- Pilot software training
- Various training courses

MEL-SCAN :

- On-site travel
- Measuring buildings
- Supply of data files

MEL-TWINKLY :

- On-site travel
- Project study
- Project wiring diagram
- Set-up of decorations/products and verification of installation
- Validation of product operation
- On-the-spot training in the use and control of Twinkly PRO technology

Our high-performance scanner enables precise 3D surveying of complex objects and buildings.

This automated dimensioning system is an invaluable asset, as it allows all necessary measurements to be taken in record time and integrates this data into the simulation of your lighting project. You can also retrieve neutral files from a simple and intuitive interface, compatible with any operating system, for all your future needs



REFERENCE

MEL-CABLAGE

MEL-PREPA

MEL-ASSIST

MEL-FORMA

MEL-SCAN

MEL-TWINKLY

Sound & lighting

Thanks to our project managers specialized in creating sound and light shows, your installations (Christmas trees, ceilings, etc.) come to life during events.

Sound and light shows tell a story, whether imaginary or historical. Depending on the location and the atmosphere you wish to create, we can offer solutions tailored to your needs. A light show can be installed in a place rich in history: a historic building, a facade, an avenue... In this way, you can highlight your heritage and reveal details that might otherwise go unnoticed! Spectators are captivated, and it's up to you to fill them with even more wonder: light, sound, fragrance... Programmed scenes or sensor-triggered – anything is possible to accompany your story.

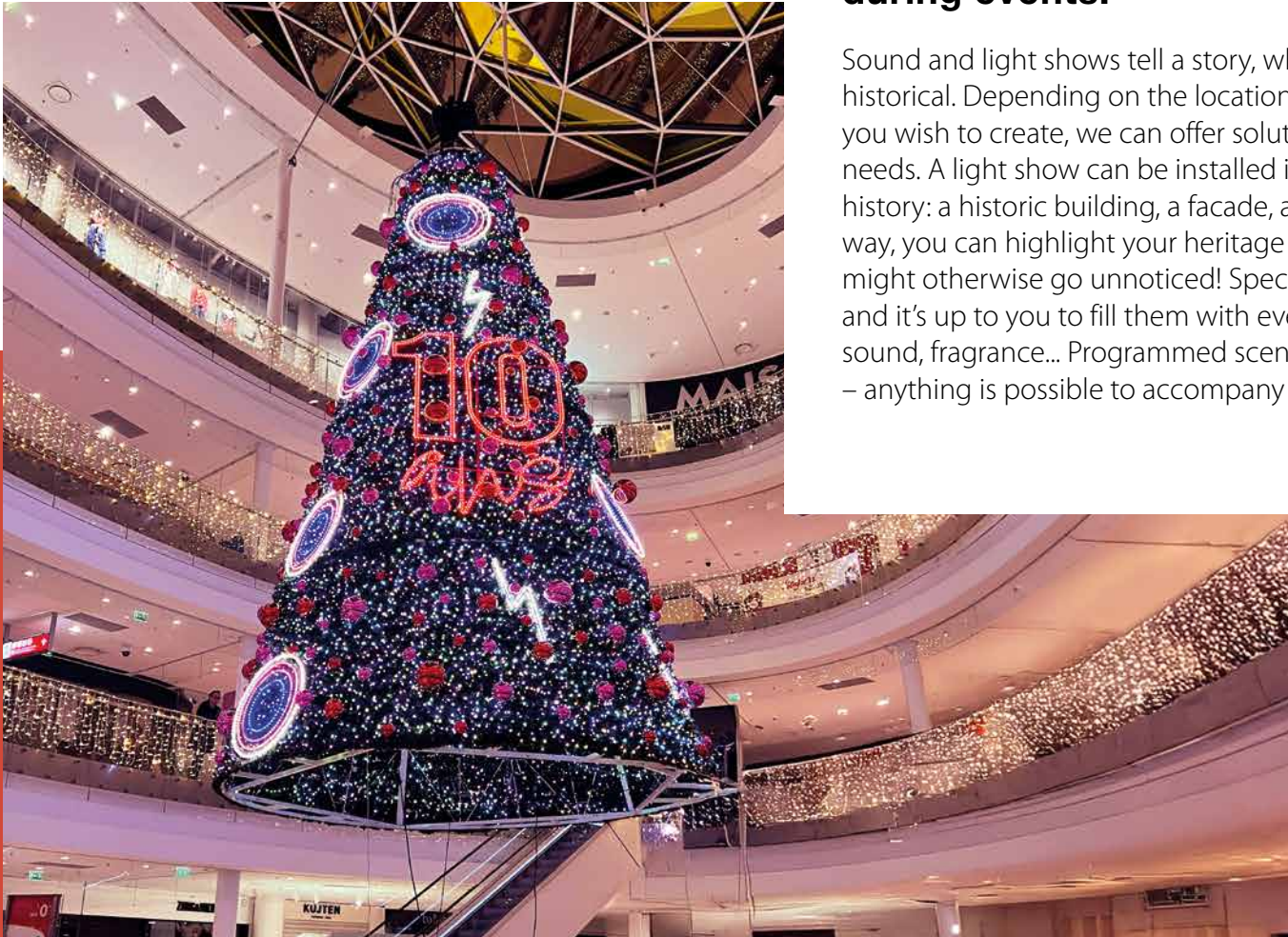

Beaugrenelle Shopping Center • France
Design Bruno Dolis

Megève • France



Domaine de Grenade • France



NATIONAL DAY



Le Mans • France



SYNCHRONISED CONCERT
& ILLUMINATIONS

wet

Weather
Exterior
Technology

A UNIQUE RANGE OF IP65 MOVING HEADS
100% ALUMINIUM BODY



Starway

The magic of light

STARWAY.EU | contact@starway.eu





starway.eu



Technical Appendix

COMPLIANCE OF OUR PRODUCTS

All Leblanc illuminations' products comply with all European standards and directives. The product compliance certificates are provided on request.

DIRECTIVE NAME	AREA OF APPLICATION
 2011/65/UE Directive	<p>The ROHS European directive aims to restrict the use of 6 dangerous substances (lead, mercury, cadmium, hexavalent chrome, polybrominated biphenyls (PBBs), and polybrominated diphenyl ethers (PBDEs).</p> <p>RoHS signifies 'Restriction of the use of certain Hazardous Substances' in electrical and electronic equipment.</p>
 2012/19/UE Directives	<p>Waste Electronic and Electrical Equipment (WEEE) is a category of waste defined by European regulations as 'equipment functioning with electric currents or electromagnetic fields, as well as equipment which produces, transfers, and measures these currents and fields, designed to be used at a voltage which does not exceed 1000 volts AC and 1500 volts DC'.</p> <p>In Europe, this directive aims to make the recycling of WEEE mandatory and establish the principle of producers' responsibility. Consumers will contribute to this process by paying an eco-contribution or eco-tax, included in the purchase price for new equipment.</p>

INTERNATIONAL PROTECTION

IP is the protection index against solids and liquids. Outside, the minimum protection index is IP44.

I P X X

1st protection figure = SOLIDS

2nd protection figure = LIQUIDS

IP	PROTECTION
0	No protection.
1	Protected against solids of more than 50 mm (unintentional contact with hands).
2	Protected against solids of more than 12.5 mm (fingers).
3	Protected against solids of more than 2.5 mm (tools, screws).
4	Protected against solids of more than 1 mm (small tools, small wires).
5	Protected against dust (no harmful deposits).
6	Fully protected against dust.

IP	PROTECTION
0	No protection.
1	Protected against drops of water falling vertically (condensation).
2	Protected against drops of water up to 15° from vertical.
3	Protected against rainwater up to 60° from vertical.
4	Protected against water spray from all directions.
5	Protected against hosed water from all directions.
6	Fully protected against water spray similar to waves.
7	Protected against the effects of immersion.
8	Protected against the effects of prolonged immersion in the specified conditions (followed by an indication of the maximum immersion depth in metres).

PUBLIC ACCESSIBILITY TO 230V DECORATIONS

Installations which are accessible to the public

They are located at a height lower than 3 m above the ground or at least 1 m horizontally outwards from a balcony, terrace or any place accessible to the public. Light installations positioned directly on the ground are also included.

What precautions need to be taken?

- Extract from the standard C 17-202, § 5.1.2

'The circuits must be protected at their source by high sensitivity residual current devices (30mA) for additional protection against direct contact.'

- Extract from the standard C 17-202, § 5.2.2

'Maintained inaccessibility provides protection against direct contact. In terms of indirect contact, the circuits must be protected by a medium sensitivity residual current device (300mA). The connection must be made with fixed connections. Non-fixed connections and even inaccessible sockets are protected by high sensitivity residual current devices (30mA). If part of the temporary installation does not comply with inaccessibility regulations, the requirements of 5.1.2 must be applied at least to the part in question.'

INSTALLATIONS ACCESSIBLE TO THE PUBLIC

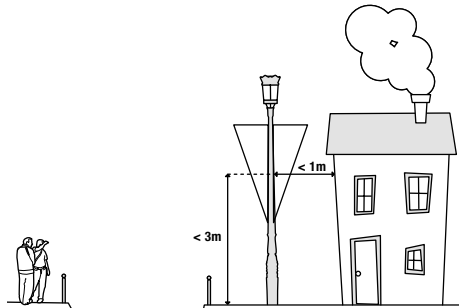
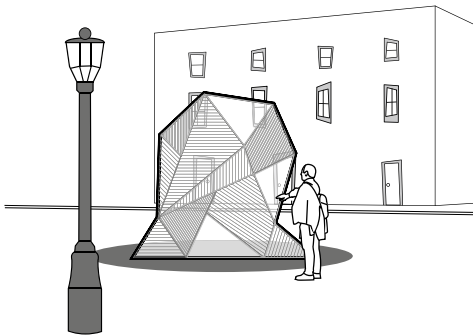

INSTALLATIONS NOT ACCESSIBLE TO THE PUBLIC

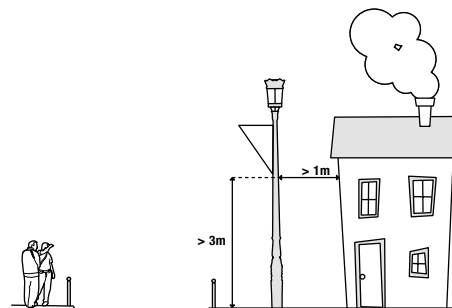
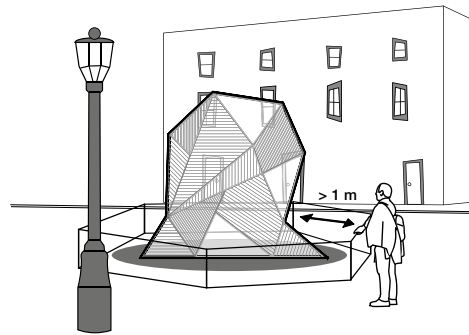

TECHNICAL VOCABULARY

AMPERE (A)

Unit which measures the intensity of current which corresponds to the number of electrons which pass through a point in a circuit per second.

VOLT (V)

Unit which measures the voltage. The voltage is the difference in electrostatic potential between two points and is associated with the energy that an electron needs to move between these two points.

WATT (W)

Unit which measures the power consumed by a product.

Calculation of the intensity of the current : $P = U \times I$

(P : power in W, U : voltage in V, I : intensity in A)

FREQUENCY (Hz)

Number of times the polarity of the signal changes per second. It is given in Hertz.

COLOUR TEMPERATURE

The colour temperature makes it possible to determine the colour of a light source. The apparent colour of a light source varies from the orange-red of a candle flame (1850 K) to the blueish colour of an electronic flash (between 5000 and 6500 K according to the manufacturer). It is measured in Kelvin (K).

- Warm white: 2600 K
- Neutral white: 3500 K
- Cool white: 4500 K



CE MARKINGS

It is mandatory for all products covered by one or several European directives which specifically provide for it. To put CE marking on a product, the manufacturer must carry out, or have carried out, checks and tests to ensure that a product complies with the essential requirements, particularly in terms of health and safety, defined in the directive(s) concerned. It is not a certification mark or an indication of the geographical origin of the product. It is mandatory and of a regulatory nature and is the visible commitment of the manufacturer that its product complies with European legislation. It gives the products concerned the right of free movement throughout the European Union.



'PROCESSING OF ELECTRIC AND ELECTRONIC PRODUCTS' END-OF-LIFE

Applied to all products except incandescent bulbs, gas bulbs, spotlights, power cables and all non-electric products

LEAKAGE CURRENT

The leakage current is current which, by definition, leaks between the active parts and the grounding connection in the absence of an electrical fault. It is part of the installation's normal functioning. The design of an electric installation must provide for residual current protection to ensure the safety of persons and goods by taking these leakages into account. These, along with the installation's upstream cables, can reach the threshold value for activating the protection. The solution is to limit the number of devices protected by the same residual current device.

For example, for 10 m of garlands, you measure leakage current equal to 0.09 mA. Knowing that a 30 mA circuit breaker is triggered at 16 mA, you need to heed to a maximum of 50 x 20 m garlands for an HPI type 30 mA differential circuit breaker.

DMX PROJECTION AND MANAGEMENT

DIAMETER PROJECTION TABLE

You can choose the projector suited to your project according to the minimum projection angle to illuminate a building from a given distance.

PROJECTION DISTANCE (IN METRES)

	1	2	3	4	5	6	7	8	9	10	11	12	13	14	15	18	20	25	30	35	40	45	50	60	70	80
10°	0.17	0.35	0.52	0.70	0.87	1.05	1.22	1.40	1.57	1.75	1.92	2.10	2.27	2.45	2.62	3.15	3.50	4.37	5.25	6.12	7.00	7.87	8.75	10.50	12.25	14.00
11°	0.19	0.39	0.58	0.77	0.96	1.16	1.35	1.54	1.73	1.93	2.12	2.31	2.50	2.70	2.89	3.47	3.85	4.81	5.78	6.74	7.70	8.67	9.63	11.55	13.48	15.41
12°	0.21	0.42	0.63	0.84	1.05	1.26	1.47	1.68	1.89	2.10	2.31	2.52	2.73	2.94	3.15	3.78	4.20	5.26	6.31	7.36	8.41	9.46	10.51	12.61	14.71	16.82
13°	0.23	0.46	0.68	0.91	1.14	1.37	1.60	1.82	2.05	2.28	2.51	2.73	2.96	3.19	3.42	4.10	4.56	5.70	6.84	7.98	9.11	10.25	11.39	13.67	15.95	18.23
14°	0.25	0.49	0.74	0.98	1.23	1.47	1.72	1.96	2.21	2.46	2.70	2.95	3.19	3.44	3.68	4.42	4.91	6.14	7.37	8.59	9.82	11.05	12.28	14.73	17.19	19.65
15°	0.26	0.53	0.79	1.05	1.32	1.58	1.84	2.11	2.37	2.63	2.90	3.16	3.42	3.69	3.95	4.74	5.27	6.59	7.90	9.22	10.53	11.85	13.17	15.80	18.53	21.06
16°	0.28	0.56	0.84	1.12	1.41	1.69	1.97	2.25	2.53	2.81	3.09	3.37	3.65	3.94	4.22	5.06	5.62	7.03	8.43	9.84	11.24	12.65	14.05	16.86	19.68	22.49
17°	0.30	0.60	0.90	1.20	1.49	1.79	2.09	2.39	2.69	2.99	3.29	3.59	3.89	4.18	4.48	5.38	5.98	7.47	8.97	10.46	11.96	13.45	14.95	17.93	20.92	23.91
18°	0.32	0.63	0.95	1.27	1.58	1.90	2.22	2.53	2.85	3.17	3.48	3.80	4.12	4.43	4.75	5.70	6.34	7.92	9.50	11.09	12.67	14.25	15.84	19.01	22.17	25.34
19°	0.33	0.67	1.00	1.34	1.67	2.01	2.34	2.68	3.01	3.35	3.68	4.02	4.35	4.69	5.02	6.02	6.69	8.37	10.04	11.71	13.39	15.06	16.73	20.08	23.43	26.77
20°	0.35	0.71	1.06	1.41	1.76	2.12	2.47	2.82	3.17	3.53	3.88	4.23	4.58	4.94	5.29	6.35	7.05	8.82	10.58	12.34	14.11	15.87	17.63	21.16	24.69	28.21
21°	0.37	0.74	1.11	1.48	1.85	2.22	2.59	2.97	3.34	3.71	4.08	4.45	4.82	5.19	5.56	6.67	7.41	9.27	11.12	12.97	14.83	16.68	18.53	22.24	25.95	29.65
22°	0.39	0.78	1.17	1.56	1.94	2.33	2.72	3.11	3.50	3.89	4.28	4.67	5.05	5.44	5.83	7.00	7.78	9.72	11.66	13.61	15.55	17.49	19.44	23.33	27.21	31.10
23°	0.41	0.81	1.22	1.63	2.03	2.44	2.85	3.26	3.66	4.07	4.48	4.88	5.29	5.70	6.10	7.32	8.14	10.17	12.21	14.24	16.28	18.31	20.35	24.41	28.48	32.55
24°	0.43	0.85	1.28	1.70	2.13	2.55	2.98	3.40	3.83	4.25	4.68	5.10	5.53	5.95	6.38	7.65	8.50	10.63	12.75	14.88	17.00	19.13	21.26	25.51	29.76	34.01
25°	0.44	0.89	1.33	1.77	2.22	2.66	3.10	3.55	3.99	4.43	4.88	5.32	5.76	6.21	6.65	7.98	8.87	11.08	13.30	15.52	17.74	19.95	22.17	26.60	31.04	35.47
26°	0.46	0.92	1.39	1.85	2.31	2.77	3.23	3.69	4.16	4.62	5.08	5.54	6.00	6.46	6.93	8.31	9.23	11.54	13.85	16.16	18.47	20.78	23.09	27.70	32.32	36.94
27°	0.48	0.96	1.44	1.92	2.40	2.88	3.36	3.84	4.32	4.80	5.28	5.76	6.24	6.72	7.20	8.64	9.60	12.00	14.40	16.81	19.21	21.61	24.01	28.81	33.61	38.41
28°	0.50	1.00	1.50	1.99	2.49	2.99	3.49	3.99	4.49	4.99	5.49	5.98	6.48	6.98	7.48	8.98	9.97	12.47	14.96	17.45	19.95	22.44	24.93	29.92	34.91	39.89
29°	0.52	1.03	1.55	2.07	2.59	3.10	3.62	4.14	4.66	5.17	5.69	6.21	6.72	7.24	7.76	9.31	10.34	12.93	15.52	18.10	20.69	23.28	25.86	31.03	36.21	41.38
30°	0.54	1.07	1.61	2.14	2.68	3.22	3.75	4.29	4.82	5.36	5.89	6.43	6.97	7.50	8.04	9.65	10.72	13.40	16.08	18.76	21.44	24.12	26.79	32.15	37.51	42.87
31°	0.55	1.11	1.66	2.22	2.77	3.33	3.88	4.44	4.99	5.55	6.10	6.66	7.21	7.77	8.32	9.98	11.09	13.87	16.64	19.41	22.19	24.96	27.73	33.28	38.83	44.37
32°	0.57	1.15	1.72	2.29	2.87	3.44	4.01	4.59	5.16	5.73	6.31	6.88	7.46	8.03	8.60	10.32	11.47	14.34	17.20	20.07	22.94	25.81	28.67	34.41	40.14	45.88
33°	0.59	1.18	1.78	2.37	2.96	3.55	4.15	4.74	5.33	5.92	6.52	7.11	7.70	8.29	8.89	10.66	11.85	14.81	17.77	20.73	23.70	26.66	29.62	35.55	41.47	47.39
34°	0.61	1.22	1.83	2.45	3.06	3.67	4.28	4.89	5.50	6.11	6.73	7.34	7.95	8.56	9.17	11.01	12.23	15.29	18.34	21.40	24.46	27.52	30.57	36.69	42.80	48.92
35°	0.63	1.26	1.89	2.52	3.15	3.78	4.41	5.04	5.68	6.31	6.94	7.57	8.20	8.83	9.46	11.35	12.61	15.76	18.92	22.07	25.22	28.38	31.53	37.84	44.14	50.45
36°	0.65	1.30	1.95	2.60	3.25	3.90	4.55	5.20	5.85	6.50	7.15	7.80	8.45	9.10	9.75	11.70	13.00	16.25	19.50	22.74	25.99	29.24	32.49	38.99	45.49	51.99
37°	0.67	1.34	2.01	2.68	3.35	4.02	4.68	5.35	6.02	6.69	7.36	8.03	8.70	9.37	10.04	12.05	13.38	16.73	20.08	23.42	26.77	30.11	33.46	40.15	46.84	53.54
38°	0.69	1.38	2.07	2.75	3.44	4.13	4.82	5.51	6.20	6.89	7.58	8.26	8.95	9.64	10.33	12.40	13.77	17.22	20.66	24.10	27.55	30.99	34.43	41.32	48.21	55.09
39°	0.71	1.42	2.12	2.83	3.54	4.25	4.96	5.67	6.37	7.08	7.79	8.50	9.21	9.92	10.62	12.75	14.16	17.71	21.25	24.79	28.33	31.87	35.41	42.49	49.58	56.66
40°	0.73	1.46	2.18	2.91	3.64	4.37	5.10	5.82	6.55	7.28	8.01	8.74	9.46	10.19	10.92	13.10	14.56	18.20	21.84	25.48	29.12	32.76	36.40	43.68	50.96	58.24
60°	1.15	2.31	3.46	4.62	5.77	6.93	8.08	9.24	10.39	11.55	12.70	13.86	15.01	16.17	17.32	20.78	23.09	28.87	34.64	40.41	46.19	51.96	57.74	69.28	80.83	92.38

DMX: DIGITAL MULTIPLEXING

The DMX is a protocol which came out of the USA and was introduced in 1986. It is a copyright-free system and it is cheap to implement. The DMX protocol is a switchboard for transmitting information between controls and remote receivers. Everything is based on digital pulse trains made up of square waves transmitted cylindrically on a frequency of 250 kHz. 24 to 512 channels can be transmitted on the same frame, with 512 possible Start codes.

Precautions:

- It has low voltage, so you need to avoid being close to high-emission high voltage.
- The voltage compared to the mass = - 7V to + 12V.
- The current between 2 conductors must be min. 200 mV.
- Y connections are strictly prohibited. You must use an amp junction box.
- The signal must be re-amplified approx. every 200 m or every 20 products.

INSTALLING A CEILING LIGHT

EXAMPLE: to fit a 100 m long x 4 m wide street with an led ceiling light

CALCULATE THE MINIMUM NUMBER OF ATTACHMENT POINTS

$$\frac{100}{9.6} = 10.41$$

Length of street

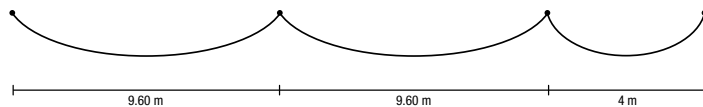

You need 12 attachment points (or ropes):
10 spaces of 9.6 m + 11th space of 4 m

CALCULATE THE NUMBER OF CONNECTORS ACROSS (REF.058919)

$$\frac{4}{1} = 4$$

Width of street

Length of connector

You need 4 connectors width-wise.

CALCULATE THE TOTAL NUMBER OF 20 M GARLANDS

Given that you need 4 connector cables width-wise and that each connector has 4 connection points, there will be 16 garland outlets ($4 \times 4 = 16$). We also have 10 spaces of 9.6 m (knowing that you need 10 m of garland to cover 9.6 m of ceiling) + 1 space of 4 m (that we could cover with 5 m of garland).

For each of the 16 lengths, you will need 5 x 20 m garlands + 1 x 5 m garland:

- 16 outlets of 5 x 20 m garlands = $16 \times 5 = 80$ x 20 m garlands.
- 16 additions of 5 m = $\frac{16 \times 5}{20} = 4$ x 20 m garlands (dividable every 5 m).

To do this street's 'ceiling', you will therefore need 84 x 20 m garlands.

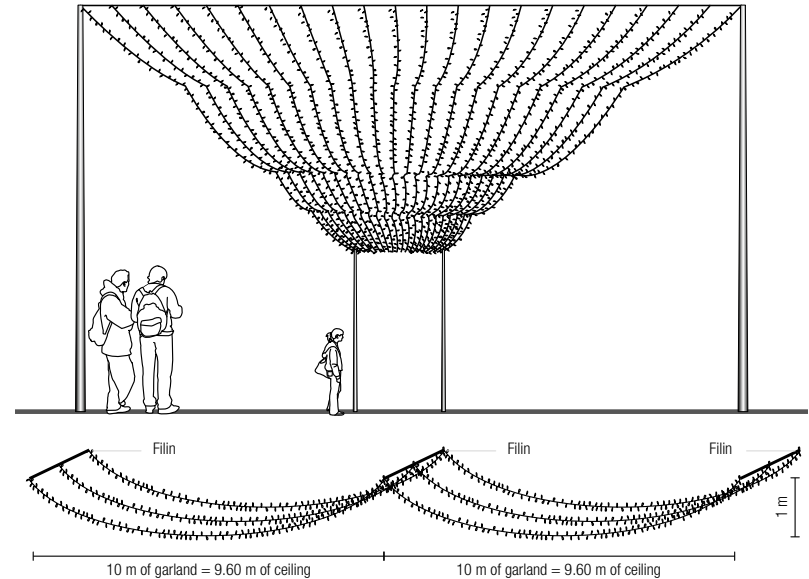

N.B.: For 10 m of garland, you can only cover 9.6 m of ceiling. You therefore need to have attachment points every 9.6 m or less.

CALCULATE THE NUMBER OF SUPPLIES (REF.550663 + 300002)

Given that a fixed LED garland uses 17W/230V, the total use for the ceiling will be: $84 \times 17 = 1428$ W.

We are limited in terms of power here by the power cable, which can handle a maximum power of 920W/230V

(because of the 4A rectifier). So: $\frac{1428}{920} = 1,55$

2 power cables are therefore required.

INSTALLING A CEILING LIGHT

Examples of cabling :

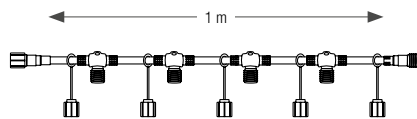
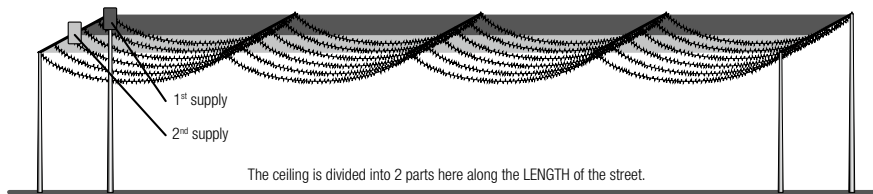
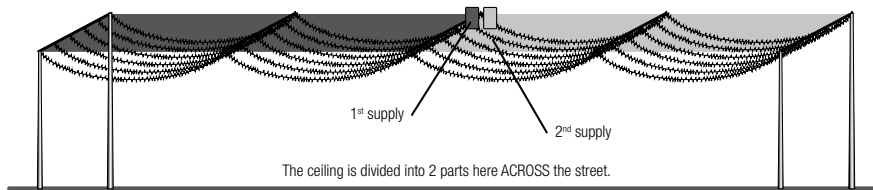
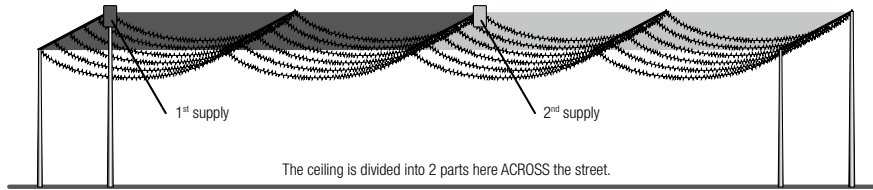

058919
2-wire connector cable for fixed LED garlands (see p.269)

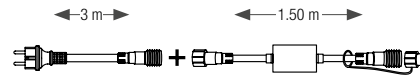

550663 + 300002
Power cable + 4A rectifier (see p.268)



FITTING A TREE WITH LIGHTING GARLANDS

CALCULATE THE PERIMETER OF THE TREE

$$P = \pi \times D$$

Perimeter in m = 3.14 Diameter in m

CALCULATE THE NUMBER OF GARLAND COILS (NC) (0.3 M BETWEEN EACH COIL)

$$NC = \frac{H}{0.3}$$

Number of coils

CALCULATE THE TOTAL LENGTH (TL) OF GARLANDS REQUIRED

$$LT = \frac{NC \times P}{2}$$

Total length in m

CALCULATE THE NUMBER OF GARLANDS (NG) REQUIRED

$$NG = \frac{LT}{LG}$$

Number of garlands Length of garland used in m

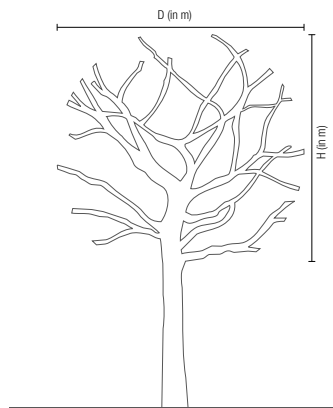

EXAMPLE

CALCULATE THE PERIMETER OF THE TREE

$$P = \pi \times 4.5 = 14.13 \text{ m}$$

CALCULATE THE NUMBER OF GARLAND COILS (NC) (0.3 M BETWEEN EACH COIL)

$$NC = \frac{6}{0.3} = 20$$

CALCULATE THE TOTAL LENGTH (TL) OF GARLANDS REQUIRED

$$TL = \frac{20 \times 14.13}{2} = 141.3 \text{ m}$$

CALCULATE THE NUMBER OF GARLANDS (NG) REQUIRED

$$NG = \frac{141.3}{20} = 7.065$$

or 8 garlands are therefore required, depending on the density desired

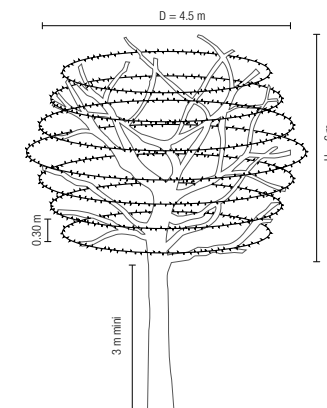

FITTING A FIR TREE WITH LIGHTING GARLANDS

CALCULATE THE PERIMETER OF THE TREE

$$P = \pi \times D$$

Perimeter in m = 3.14 Diameter in m

CALCULATE THE NUMBER OF GARLAND COILS (NC) (0.3 M BETWEEN EACH COIL)

$$NC = \frac{H}{0.3}$$

Number of coils

CALCULATE THE TOTAL LENGTH (TL) OF GARLANDS REQUIRED

$$TL = \frac{NT \times P}{2}$$

Total length in m

CALCULATE THE NUMBER OF GARLANDS (NG) REQUIRED

$$NG = \frac{LT}{LG}$$

Number of garlands Length of garland used in m

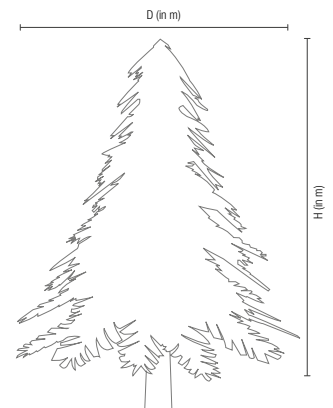

EXAMPLE

CALCULATE THE PERIMETER OF THE TREE

$$P = \pi \times 3 = 9.42 \text{ m}$$

CALCULATE THE NUMBER OF GARLAND COILS (NC) (0.3 M BETWEEN EACH COIL)

$$NC = \frac{8}{0.3} = 26.66$$

CALCULATE THE TOTAL LENGTH (TL) OF GARLANDS REQUIRED

$$TL = \frac{26.66 \times 9.42}{2} = 125.6 \text{ m}$$

CALCULATE THE NUMBER OF GARLANDS (NG) REQUIRED

$$NG = \frac{125.6}{20} = 6.28$$

garlands are therefore required to decorate this tree.

- N.B.: Depending on requirements, you can reduce or increase the space between the garlands:
- dense tree: 0.15 m
 - normal tree: 0.30 m
 - light tree: 0.50 m

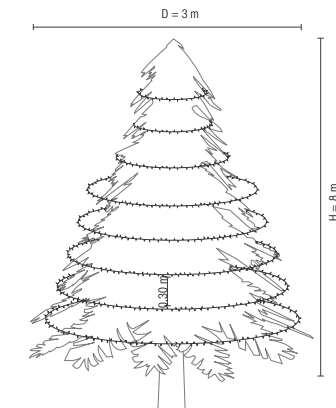

FITTING A TREE WITH B22 GARLANDS

CALCULATE THE PERIMETER OF THE TREE

$$P = \pi \times D$$

Perimeter in m / $\pi = 3,14$ / Diameter in m

CALCULATE THE NUMBER OF GARLAND COILS (NC) (1 M BETWEEN EACH COIL)

$$NC = \left(\frac{H}{1} \right) / 2$$

Number of coils

CALCULATE THE TOTAL LENGTH (TL) OF GARLANDS REQUIRED

$$TL = NC \times P$$

Total length in m

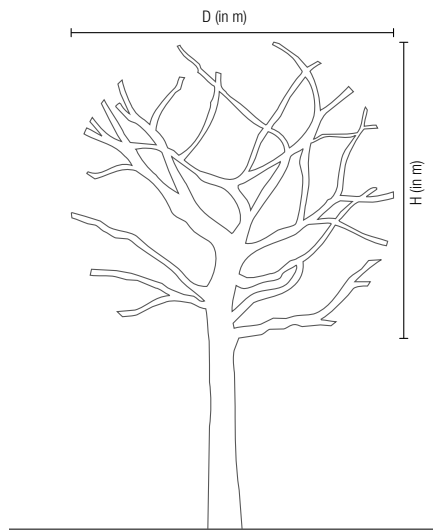

EXAMPLE

CALCULATE THE PERIMETER OF THE TREE

$$P = \pi \times 5 = 15,7 \text{ m}$$

CALCULATE THE NUMBER OF GARLAND COILS (NC) (1 M BETWEEN EACH COIL)

$$NC = \frac{8}{2} = 4$$

CALCULATE THE TOTAL LENGTH (TL) OF GARLANDS REQUIRED

$$TL = 4 \times 15,7 = 62,8 \text{ m}$$

Depending on the density desired, take either a 50 m/140 socket garland or a 50 m/200 socket garland.

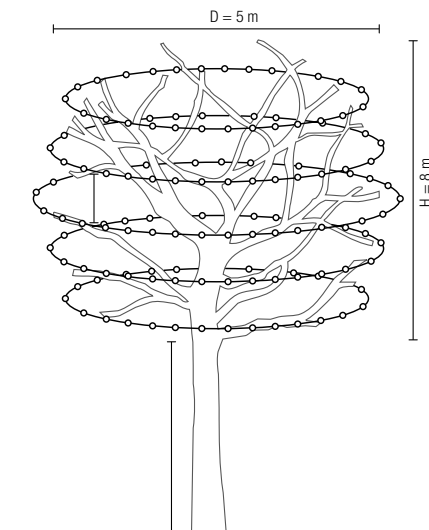

FITTING A FIR TREE WITH B22 GARLANDS

CALCULATE THE PERIMETER OF THE TREE

$$P = \pi \times D$$

Perimeter in m / $\pi = 3.14$ / Diameter in m

**CALCULATE THE NUMBER OF GARLANDS (NG)
(2 M BETWEEN EACH DROP)**

$$NG = \frac{P}{2}$$

Number of garlands

CALCULATE THE LENGTH (LG) OF A GARLAND DROP

$$LG = \sqrt{H^2 + \left(\frac{D}{2}\right)^2}$$

Total length in m

CALCULATE THE TOTAL LENGTH (TL) REQUIRED

$$TL = LG \times NG$$

Total length in m

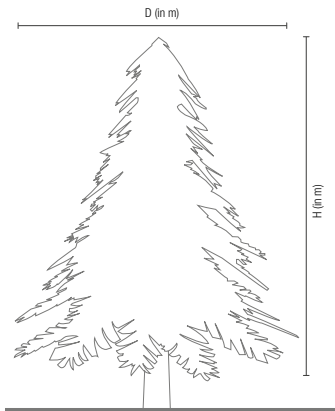

EXAMPLE

CALCULATE THE PERIMETER OF THE TREE

$$P = \pi \times 6 = 18.84 \text{ m}$$

CALCULATE THE NUMBER OF GARLANDS (NG)

$$NG = \frac{18.84}{2} = 9.42$$

CALCULATE THE LENGTH (LG) OF A GARLAND DROP

$$LG = \sqrt{10^2 + \left(\frac{6}{2}\right)^2} = 10.44 \text{ m}$$

CALCULATE THE TOTAL LENGTH (TL) REQUIRED

$$TL = 10.44 \times 9.42 = 98.34 \text{ m}$$

➤ A 100 m B22 garland is therefore required.

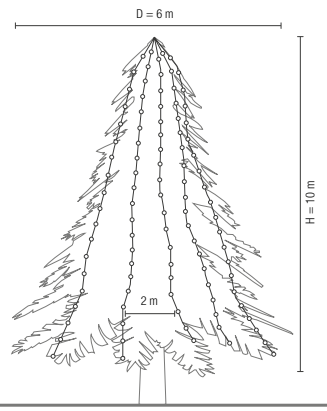

Index

A

ABBY	74
AGATHE	91, 95
AGATHE BONNES FÊTES	91
ALPI	69
ALYA	80
ALYA DROIT	81
ALYA GAUCHE	81
ALYA INFINITY	166
ARBRE MAGIQUE	154
ARCEAU ALPI	115
ARCEAU BOULE	115
ARCEAU CADEAU	115
ARCEAU CANDY	133
ARCEAU MILLÉSIME	115
ARCEAU MUFFIN	133
ARCEAU SPIRALE	133
ARCHE	171
ARCHE 3D	171
ARCHE 3D INFINITY	171
ARCHE BOULE	107
ARCHE CADEAU	54, 106
ARCHE CASSE-NOISETTE	106
ARCHE CHAMPAGNE	107
ARCHE CIRCULAIRE	171
ARCHE COLLIER	74
ARCHE ÉTOILE	106
ARCHE FILANTE	77
ARCHE LUMINEUSE	171
ARCHE MILLÉSIME	81
ARCHE NEIGE	64
ARCHE NOËL	107
ARCHE NCEUD	80
ARCHE NOVA	107
ARCHE RUBAN	80
ARCHE SAPIN	106
ARCHE SAPIN COURBÉ	106
ARCHE SAPINETTE	106, 171
ARCHÉTOILE	107
ARCHE XMAS	107
ARMONY	74, 77, 80
ASTRA	75
ATMOS	90
AUGUSTIN LE LUTIN	137
AUTOMOBILE	
DÉCOR 3D À POSER.	127
AVION	126
AYDEN	48, 49

B

BATEAU PIRATE	127
BAUBLE CHAIR	122
BICHE FÉRIQUE	143
BIG CAKE	131
BOA CHIC	55

BOA GIVRÉ	62
BOA TRADI	57
BOÎTE AUX LETTRES	136
BOÎTE DU PÈRE NOËL	139
BOÎTE LUTIN	137
BOÎTE NOËL	136
BOÎTE SANTA	139
BONHOMME DE NEIGE FUNKY	138
BONNET	144
BONNET LUDIQUÉ	57
BOUGIE PÉTILLANTE	110
BOULE	50, 54
BOULE ARTY	114
BOULE CHOUPI	139
BOULE DÉCO	149
BOULE DÉCO INFINITY	167
BOULE ÉTINCELANTE	111
BOULE M & L	148
BOULE L INFINITY	167
BOULE LUDIQUÉ	49
BOULE M INFINITY	166
BOULE NOËLLA	55
BOULE PÉTILLANTE	110
BOULE S	132, 149
BOULE S INFINITY	166
BOULE STAR	114
BOULE VINTAGE	90
BOULLIZ'	169, 138
BOUQUETIN GLACÉ	142
BULLE D'OR	91
BULLE DORÉE	148

C

CACHE OREILLE	145
CADEAU	54, 148, 149
CADEAU CHOUPI	139
CADEAU COUCHÉ	148
CADEAU ÉTINCELANT	111
CADEAU FUNKY	56
CADEAU INFINITY	166
CADEAU LUDIQUÉ	49
CADEAU	149
CADEAU PÉTILLANT	110
CADEAU PHOTO	118
CADEAU RUBAN	118
CADEAUX FESTIFS	130
CADRE DE NOËL	119
CADRE LUMINEUX	169
CADRE OURS	119
CADRE PÈRE NOËL	118
CADRE PHOTO	119, 169
CADRE PINGOUIN	118
CADRE RENNE	119
CANDY LUDIQUÉ	56
CANNE	145
CANNELLE	48, 49

CARILLON	76
CARROSSE INFINITY	166
CARROUSEL DE NOËL	143
CARROUSEL MACARONS	130
CASSE-NOISETTE	137
CERF FÉRIQUE	143
CHAMOIS	142
CHANDELIER	80
CHAPEAU	145
CHAPIN DE NOËL	137
CHARMILLE INFINITY	167
CHEVAL	142
CHEVAL À BASCULE	127
CHRISTMAS BAUBLE XL	148
CÎMIER CÔNE GIVRÉ	152
CÎMIER ÉTOILÉ	155
CIMIER GIVRE	152
CIMIER HOLLY	156
CIMIER MAGIE	155
CŒUR PÉTILLANT	110
COLLIER	74, 76
CÔNE ARLEQUIN	153
CÔNE ESSENTIEL	154
CÔNE FUNKY	156
CÔNE GIVRÉ	155
CÔNE GOURMAND	131
CÔNE INFINITY	167
COURONNE	145
COURONNE S	76
COURONNE DE NOËL	55
COURONNE ENCHANTÉE	95
COURONNE FILAMENT	89
COURONNE GLACÉE	68
COURONNE MERRY	50
COURONNE SONGE	94
COURONNE VINTAGE	90
CRAVATE	144
CRISTAL	68
CRYSTAL FLAKE	69
CRYSTAL M INFINITY	166
CUPCAKE	132

D

DAIM	143
DREAM	94
DREAM BONNES FÊTES	94
DREAM CERF	94
DREAM HIBOU	94
DREAM RENARD	94
DREAM RENNE	94
DREAM XMAS	94

E

ÉCHARPE	144
---------	-----

ÉCLAIR	122
ECLAT PÉTILLANT	111
ELFIE	89
ÉTOILE CHOUPI	139
ÉTOILE ÉTINCELANTE	111
ÉTOILE GIVRÉE	91
ÉTOILE GOURMANDE	48
ÉTOILE INFINITY	167
ÉTOILE NOVA	114
ÉTOILE PAIN D'ÉPICE	132
ÉTOILE PÉTILLANTE	110
ÉTOILE VINTAGE	90

F

FAUTEUIL CADEAU	123
FAUTEUIL NOËL	123
FAUTEUIL OURS	123
FAUTEUIL RENNE	123
FILAMENT	89
FLAKE	114
FLOCON	64, 65
FLOCON PÉTILLANT	110
FLOCON STRASS LED	69
FLOCON VINTAGE	90
FONTAINE E-DECO	167
FROZEN	62
FUNKY	56
FUSÉE	127

G

GINGER CHOUPI	139
GINGER FUNKY	56
GINGER LUDIQUÉ	49
GINGER PÉTILLANT	110
GIVRE	63
GOUTTE ALYA	76
GRANDE LOUISE	81, 83
GRANDE ROUE	127
GRAND PINGOO	144
GRAND RUDOLPHE	144
GRAND SYLVESTRE	156
GROS CADEAU	148

H

HOLLY	51
HOUX PÉTILLANT	110

I

IGLOO	142
INAYA	76

J

JARDIN FÉRIQUE	91
J'M MA VILLE	114
JOY	51, 82, 63, 95
JOY ÉTOILE	57, 82
JOYEUSES FÊTES	91
JOYEUSES FÊTES	174
JOYEUSES FÊTES	77
JOYEUSES FÊTES EN FOLIE	77
JOYEUSES FÊTES RUBAN	81
JOYEUSES FÊTES SONGE	91
JOYEUX CADEAU	54
JOYEUX NOËL	119
JOY FLOCON	62
JOY GOUTTE	95
JOY LOSANGE	95

K

KIOSQUE	119
KIOSQUE INFINITY	166
KIT BOULES ABBY L	157
KIT CÔNE ESSENTIEL PERS.	154
KIT FROSTY	138
KIT NOEUDS ABBY	157
KIT RUDY	138

L

LA BOÎTE DES LUTINS	137
LANTERNE	50
LANTERNE MELLOW	50
LOOMIE	285
LOUISE	80, 81, 83
LUGE DES LUTINS	126
LUNETTES	145
LUSTRE BOUGIES	49
LUSTRE COLLIER	74
LUSTRE DENTELLE	90
LUSTRE JOY DIAMANT	95
LUSTRE JOY ÉTOILE	57, 82
LUSTRE JOY FLOCON	62
LUSTRE JOY GOUTTE	95
LUSTRE PLUMES	94
LUSTRE TRADI	49
LUTIN FUNKY	56
LUTIN OUPS	138
LUTIN PHOTO	118

M

MACARONS	130
MAGIE	75, 83
MAISON BISCUIT	126
MAISON PAIN D'ÉPICE	132

MANDALA	75
MAXI CADEAU	149
M BISCUIT	132
MEILLEURS VŒUX	54
MEL-CABLAGE	299
MEL-PREPA	299
MEL-PRESTA	299
MEL-SCAN	299
MERRY CHRISTMAS	174
MILA	81
MILLÉSIME	80, 81
MINI CADEAU	149
MIRA BOULE	88
MIRA ÉTOILE	82
MIRA FLOCON	62
MIRA TRADI	57
M. NOËL	136
MODULE ASSISE	173
MODULE BANC	173
MODULE PLAFOND	173
MR. NEIGE CHOUPI	138

N

NAÉ FLOKO	95
NAÉ STELLIZ	83
NEIGE FUNKY	56
NEIGE OUPS	137
NOËL FILANT	54
NOËLLA	55
NOËL OR	89
NCEUD	76, 80, 81
NCEUD PAPILLON	145
NORDIC	64
NOUGAT	145
NOVA	77

O

ONDE ENCHANTÉE	89
ORIFLAMME	173
ORIFLAMME FLOCON	68
OURS FUNKY	56, 144
OURSON CHOUPI	145

P

PARAPLUIE	144
PÈRE NOËL	111
PÈRE NOËL CADEAU	136
PÈRE NOËL CHOUPI	136
PÈRE NOËL FUNKY	56, 136
PÈRE NOËL OUPS	139
PETIT ALYA	153
PETIT AMAYA	153
PETIT CÔNE GOURMAND	131

PETITE COURONNE DREAM	94
PETITE LANterne	88
PETITE LOUISE	81, 83
PETIT RENNE	126
PETIT TRAIN	126
PETIT TRAINEAU	123
PINGOO	142
PINGOUIN CHOUPI	142
PINGOUIN FUNKY	144
PÔLE NORD	118
POMME D'AMOUR	131
POMPON	138
POP LANterne	50
POT ALYA	154
PRÉCIEUSE COURONNE	77

R

RENNE	140, 142
RENNE COMÈTE	140, 142
RENNE FANTASTIQUE	143
RENNE FANTASTIQUE INFINITY	167
RENNE FÉRIQUE	143
RENNE FUNKY	56, 144
RENNE PÉTILLANT	110
RENNES E-DECO	140, 142
RUBAN FLOCON	64
RUBAN INFINITY	166
RUDOLPHE	142

S

SANTA	136
SAPIN ABBY	157
SAPIN BOULES	153
SAPIN CADEAUX	157
SAPIN COURONNES	156
SAPIN DIAMANT	152
SAPIN ÉTINCELANT	111
SAPIN ÉTOILÉ	154
SAPIN FLOCONS	152
SAPIN GIVRE	152
SAPIN HOLLY	156
SAPIN INFINITY	166
SAPIN	114
SAPIN LOUISE SOCLE	152
SAPIN LUDIQUE	51
SAPIN MAGIE	155
SAPIN PAILLETÉ	155
SAPIN PÉTILLANT	110
SAPIN RUBAN	155
SAULE ENCHANTÉ	154
SAUTOIR	156
SNOW	76, 83
SNOW FLAKE	69
SNOWMAN	115

SNOWMAN PÉTILLANT	111
SNOWY	65
SOUPLE DIAMANT	49
SOUPLE ENCHANTÉE	89
SOUPLE FILAMENT	89
SOUPLE FLOCON	63
SOUPLE GIVRÉE	63
SOUPLE GLACÉE	63
SOUPLE LOUISE	74
SOUPLE MERRY	89
SPHÈRE INFINITY	167
SPHÈRE PLIABLE	57
SPIRALE INFINITY	167
STARLIGHT	57, 63
SUCETTE	130
SUCRES D'ORGE	131
SUCRES D'ORGE PÉTILLANT	110
SYLVESTRE CADEAUX	156

T

TONNERRE	122
TORNADE	122
TRAINEAU CRISTAL	123
TRAINEAU DE LAPONIE	122
TRAINEAU E-DECO	140, 142
TRAINOSSIMO	136
TROIS SUCETTES	130

V

VOITURE DE COURSE	127
-------------------	-----

W

WAGON	126
WINTER	68

Z

ZÉBULON	89
ZEF	95



Index

REFERENCE	PAGE	REFERENCE	PAGE	REFERENCE	PAGE	REFERENCE	PAGE	REFERENCE	PAGE	REFERENCE	PAGE	REFERENCE	PAGE	REFERENCE	PAGE		
000002	280	032242	182	050184	279	050989	257	051266	265	059711	250	060980	280	170292	275	170808	273
001242	280	032274	184	050475	184	050992	263	051267	265	059712	250	061020	280	170296	275	170809	273
001813	280	032275	184	050476	268	051010	246	051268	265	059713	250	061024	280	170300	275	170810	273
001814	280	032279	269	050477	268	051012	246	051289	265	059714	250	061030	280	170304	275	170811	273
001867	251	032283	268	050479	269	051013	246	055193	251	059715	250	061052	280	170308	275	170823	173
001948	183	032289	181	050487	269	051016	279	055476	251	059763	256	061056	280	170312	275	170824	173
001949	183	032327	183	050508	239	051026	253	057032NRB	256, 257	059783	258	061061	280	170316	275	170833	274
010001	185	032337	269	050526	219	051032	246	058242	257	059805	233	061107	280	170320	275	170838	274
010011	185	032338	268	050540	222	051033	246	058260	256, 257	059838	256	061218	194, 271	170324	275	170866	154
010014	185	032339	268	050541	239	051034	246	058772	257	059910	269	061219	194, 271	170328	275	170868	157
010019PA	287	032341	182	050562	280	051035	246	058776	257	059914	209	061220	194, 271	170332	275	170871	157
010020	287	032342	268	050563	280	051036	246	058785	257	059927	222	070008BL	257	170336	275	170874	157
031852	180	032353	246	050567	248	051039	180, 226	058810	257	059937	199	080063	296	170340	275	171108	81
031855	180	032355	287	050579	281	051066	279	058811	257	059974	248	080064	296	170344	275	171109	81
031858	185	032356	269	050602	230	051067	279	058814	269	059975	251	080065	296	170348	275	171232	81
031873	257	032357	269	050603	230	051069	279	058815	268	059986	184	080095	296	170348	275	180034	289, 297
031894	181	032358	184	050683	279	051072	253	058828	257	060255NR	257	080190	296, 297, 289	170655	273	180063	294
031895	180	032361	181	050685	248	051076	279	058911	248	060637	181	080191	296, 289	170658	273	180064	295
031903	268	032362	181	050686	248	051079	249	058912	248	060726	180	080192	296, 289	170662	273	180087	293
031908	268	032364	205, 271	050687	248	051081	249	058913	248	060742	280	080805	289	170701	273	180088	293
031912	268	032365	205, 271	050688	248	051082	249	058914	248	060743	280	100117	184	170702	273	180089	293
031937	183	032366	205, 271	050689	248	051083	249	058915	248	060745	280	100118	184	170703	273	180090	293
031938	183	032367	205, 271	050744	264	051083	249	058916	245, 248	060759	280	100119	184	170721	50, 274	180098	296
031939	183	032368	205, 271	050745	264	051095	203	058919	269	060790	281	100120	184	170723	274	180100	296
031940	183	032369	287	050754	225	051097	199	058940	268	060791	281	100503	180	170727	274	180101	296
031941	183	032370	181	050757	225	051098	199	058965	257	060792	281	100504	180	170738	273	180102	296
031942	183	032371	194, 205, 271	050761	265	051099	199	058968	268	060793	281	101500	180	170754	138	180108	297
031990	180	032372	271	050762	265	051100	199	058989BL	246, 268	060808	280	101640	181	170755	138	180111	296
032093	269	032373	271	050763	231	051101	199	059072	268	060809	280	105000	185	170781	273	180112	296
032094	182	032373	271	050764	231	051103	199	059080	264	060810	280	110004	289	170782	273	180113	296
032180	181	032374	268	050768	180, 226	051105	199	059237	222	060812	280	110023	191, 194	170783	273	180114	296
032187	268	032375	268	050769	180, 226	051106	199	059238	268	060813	280	110026	192	170784	273	180115	296
032188	268	032376	204, 244, 245, 268	050772	280	051107	199	059240	269	060814	280	113010	180	170785	273	180120	296
032189	268	032376	204, 244, 245, 268	050791	229	051108	199	059241	269	060817	280	113020	180	170786	273	180121	296
032190	268	050097	214	050792	229	051109	199	059243	239	060818	280	113030	180	170787	273	180122	296
032197	180	050098	214	050793	229	051111	199	059544	248	060820	280	122900	180	170788	273	180123	296
032198	180	050172	279	050795	229	051112	199	059546	257	060821	280	170149	57	170801	173	180124	296
032212	183	050174	279	050795	229	051180	232	059549	269	060822	280	170278	273	170802	173	180125	296
032220	181	050176	279	050857	265	051181	232	059556	182	060823	280	170282	273	170803	173	180126	296
032233	181	050177	279	050883	263	051187	231	059557	182	060856	280	170286	273	170804	273	180127	296
032235	182	050180	279	050885	263	051260	200	059558	182	060857	280	170286	273	170805	273	180138	296
032241	183	050182	279	050887	263	051264	247	059708	185	060959	251	170288	275	170806	273	180164	296
		050888	263	050888	263	051265	247							170807	273		

Index

REFERENCE	PAGE	REFERENCE	PAGE	REFERENCE	PAGE	REFERENCE	PAGE	REFERENCE	PAGE	REFERENCE	PAGE	REFERENCE	PAGE	REFERENCE	PAGE
204947-24V	175	205053	132	205160	95	205277	144	205493	48	205570	49	205626	174	300053	271
204948-24V	175	205054	130	205163	95	205278	144	205496	48	205571	50	205627	174	331300	251
204949-24V	175	205055	131	205201	83	205279	171	205498	48	205573	149	205628	153	351000	251
204950-24V	175	205056	130	205204	83	205280	171	205499	49	205576	148	205629	153	354000	251
204951-24V	175	205057	130	205205	83	205281	171	205500	56	205578	148	205630	55	370014	183
204952-24V	175	205058	131	205217	51	205282	173	205504	65	205581	149	205631	55	401667	184
204953-24V	175	205059	130	205220	51	205283	173	205506	65	205584	132	205632	55	411966	225
204954-24V	175	205060	131	205221	51	205284	155	205507	65	205585	156	205633	55	413000	251
204955-24V	175	205061	132	205222	51	205285	169	205508	65	205586	119	205636	55	513000	251
204956-24V	175	205062	130	205223	51	205286	169	205513	65	205587	118	205638	55	550008	200
204957-24V	175	205063	131	205225	156	205287	171	205514	65	205588	119	205641	75	550009	200
204958-24V	175	205064	131	205228	88	205288	171	205522	91	205589	118	205642	75	550011	200
204959-24V	175	205097	80	205230	88	205289	57	205525	91	205590	107	205643	157	550016	200
204960-24V	175	205098	77	205231	88	205290	51	205526	91	205591	107	205644	157	550018	236
204961-24V	175	205099	80	205232	88	205291	51	205527	48	205592	111	205646	157	550019	236
204962-24V	175	205100	74	205233	88	205292	82	205530	48	205593	111	300001	268	550042	214
204963-24V	175	205101	74	205235	152	205293	82	205532	48	205594	111	300002	268	550045	214
204964-24V	175	205102	80	205240	63	205294	82	205533	48	205595	111	300004	183	550046	214
204965-24V	175	205103	80	205241	63	205295	95	205534	49	205596	111	300006	285	550047	214
204966-24V	175	205105	171	205242	63	205297	95	205535	49	205597	89	300007	285	550054	245
204967-24V	175	205109	64	205243	63	205298	62	205536	49	205598	89	300009	289	550055	245
204982-24V	175	205112	64	205247	68	205299	62	205537	49	205599	89	300029	194	550056	245
204988	274	205114	64	205250	173	205300	62	205538	75	205604	74	300030	194	550057	245
204992	274	205115	64	205251	169, 173	205301	95	205541	75	205605	74	300031	194	550058	245
204996	274	205116	64	205252	55	205303	95	205543	75	205606	74	300034	268	550063	215
205000	185	205117	69	205253	55	205309	75	205544	75	205608	74	300035	268	550064	215
205001	274	205119	69	205254	62	205310	75	205545	75	205609	139	300036	268	550065	215
205005	274	205120	69	205255	62	205311	75	205546	75	205610	139	300038	182	550066	215
205009	274	205122	69	205256	57	205312	167	205547	75	205611	139	300039	182	550067	215
205013	274	205129	69	205257	57	205313	274	205548	75	205612	142	300040	271	550068	215
205017	274	205130	69	205261	139	205331	83	205549	90	205613	138	300041	271	550077	228
205037	171	205131	69	205262	136	205335	83	205552	90	205614	136	300042	271	550078	210
205039	169	205132	69	205263	138, 169	205349	115	205554	57	205615	139	300043	271	550079	210
205040	169	205134	57	205264	138, 169	205350	115	205557	57	205617	106	300044	271	550081	210
205044	137	205137	57	205265	127	205352	169	205559	63	205618	106, 171	300045	271	550087	261
205045	106	205138	82	205267	136	205372	122	205562	63	205619	106, 171	300046	271	550092	277
205046	143	205142	82	205268	127	205373	122	205564	95	205620	123	300047	271	550093	277
205048	133	205145	95	205269	142	205382	155	205565	82	205621	122	300048	271	550094	277
205049	133	205150	63	205271	142	205417	156	205566	57	205622	122	300049	271	550095	277
205050	133	205152	63	205274	144	205433	152	205567	62	205623	122	300050	271	550096	277
205051	133	205155	82	205275	144	205446	127	205568	95	205624	122	300051	271	550097	277
205052	133	205157	82	205276	144	205490	48	205569	49	205625	154	300052	271	550098	277
														550099	277
														550100	277
														550101	277
														550102	277
														550103	277
														550118	247
														550119	247
														550120	247
														550121	247
														550122	261
														550126	250
														550166	262
														550167	262
														550170	207
														550171	207
														550172	232
														550173	232
														550180	256
														550201	262
														550205	262
														550210	262
														550211	202
														550212	202
														550213	202
														550214	202
														550217	210
														550218	210
														550219	237
														550220	204
														550222	204
														550223	244
														550224	244
														550225	244
														550226	244
														550227	244
														550229	232
														550233	229
														550235	265
														550236	256
														550239	205
														550240	205
														550241	205

REFERENCE	PAGE	REFERENCE	PAGE	REFERENCE	PAGE	REFERENCE	PAGE	REFERENCE	PAGE	REFERENCE	PAGE	REFERENCE	PAGE	REFERENCE	PAGE
550242	205	550491	278	550645	194	550704	244	550775	262	550882	221	551069	255	551263	209
550244	205, 271	550492	278	550646	241	550705	244	550810	206	550883	221	551070	255	551264	209
550250	232	550493	278	550647	241	550707	244	550811	206	550884	221	551078	261	551266	209
550251	232	550494	278	550648	241	550708	244	550821	239	550885	198	551079	260	551267	209
550254	244	550495	183	550651	209	550710	244	550822	248	550886	198	551080	262	551271	143
550263	206	550496	183	550653	209	550711	244	550823	248	550887	198	551081	253	551272	143
550264	206	550514	271	550656	200	550713	244	550824	222	550888	198	551082	253	551273	258
550265	206	550516	240	550662	268	550714	244	550825	222	550889	198	551083	253	551274	258
550266	206	550517	240	550663	268	550716	244	550826	222	550890	198	551084	253	551277	234
550267	206	550518	240	550664	268	550717	244	550827	199	550891	198	551085	253	551290	262
550268	206	550519	240	550665	268	550719	244	550828	199	550892	198	551087	254	551306	219
550299	255	550520	240	550668	213	550720	244	550829	199	550914	222	551136	253	551307	219
550300	255	550522	216	550669	213	550722	244	550831	214	550915	222	551137	253	551308	219
550307	248	550523	226	550670	213	550723	244	550832	214	550921	216	551138	253	551309	219
550309	248	550524	226	550671	213	550725	233	550833	214	550922	216	551139	254	551310	235
550310	248	550525	226	550672	213	550726	233	550835	214	550923	215	551140	255	551311	212
550311	248	550526	227	550673	213	550727	233	550851	213	550924	215	551145	260	551312	212
550313	247	550527	227	550674	213	550728	233	550852	213	550925	209	551157	297	551313	212
550314	245, 248, 250	550528	227	550675	213	550729	245	550853	213	550926	209	551160	210	551314	212
550315	203	550529	227	550676	213	550730	245	550854	213	550930	271	551161	210	551315	224
550316	203	550530	237	550677	213	550732	247, 250, 251	550855	213	550931	271	551165	269	551316	224
550317	203	550548	207	550678	213	550733	247, 251	550856	213	550932	263	551166	230	551317	271
550334	202	550552	229	550679	213	550734	268	550857	213	550933	263	551167	239	551318	271
550336	194, 271	550553	229	550680	213	550735	268	550858	213	550934	263	551168	239	551327	224
550342	271	550555	228	550681	213	550736	249	550860	213	550935	263	551172	221	551328	224
550386	281	550556	200	550682	213	550738	194	550861	213	550936	263	551173	235	551329	224
550468	199	550557	200	550683	213	550739	194	550862	213	550937	263	551174	235	551330	224
550469	199	550558	203	550684	213	550740	194	550863	213	550938	278	551176	192	551331	224
550470	271	550559	231	550685	213	550741	195	550864	213	550939	278	551177	192	551332	224
550471	271	550560	231	550686	221	550742	195	550865	213	550940	278	551178	193	551333	224
550472	255	550561	230	550687	221	550743	195	550866	213	550941	278	551179	193	551334	224
550473	260	550562	230	550688	221	550744	195	550867	213	550942	278	551180	193	551338	231
550474	260	550563	230	550689	198	550745	195	550868	213	550949	278	551181	193	551339	231
550475	260	550565	201	550690	198	550746	195	550869	213	550965	189	551182	225	551340	228
550476	260	550568	200	550691	198	550748	195	550870	213	550966	195	551183	225	551341	228
550478	260	550569	200	550692	198	550749	195	550871	213	550967	195	551184	192	551342	207
550479	260	550570	200	550693	198	550754	194	550872	221	550968	195	551185	192	551343	199
550482	244	550572	278	550694	198	550756	245	550873	221	550974	251	551186	192	551344	199
550483	232	550575	204, 205	550695	198	550757	245	550874	221	550978	243	551212	143	551345	199
550484	232	550577	249	550696	198	550758	245	550875	221	550979	243	551221	297	551346	218
550485	232	550627	91	550697	198	550762	194	550876	221	550989	207	551222	297	551347	218
550486	232	550628	194, 271	550698	198	550763	194	550877	221	550990	243	551225	194	551348	218
550488	278	550634	253	550699	198	550765	233	550878	221	550991	243	551249	209	551349	218
550489	278	550635	253	550700	198	550766	233	550879	221	550993	206	551251	209	551350	207
550490	278	550643	201	550701	244	550767	233	550880	221	551009	194	551259	209	600171	183
		550644	201	550702	244	550768	233	550881	221	551020	198	551262	209	600428	281
														600429	281
														600430	281
														600431	281
														600432	281
														600433	281
														600434	280
														600435	280
														600436	280
														600437	280
														600438	280
														600439	280
														600440	280
														600441	280
														600442	280
														600443	280
														600444	280
														600445	280
														600446	280
														600447	280
														600448	280
														600449	280
														600450	280
														600451	280
														600452	280
														600453	280
														600595	183
														600596	183
														600700	183
														600738	183
														720102	251
														722101	181
														792001	181
														792002	181
														792101	181
														792201	181



Tivat • Montenegro

Decorations delivered with power cable and attachment kits, without bulb or satlight. All the luminous products in the catalogue are equipped with LEDs.

Eco-tax:

Due to changes in European directives and their interpretations, some of our products, which are not currently subject to this contribution, may be included in it during the year. The eco-tax scale may also change. The eco-tax is neither rebatable nor refundable.

Tax on light bulbs:

This tax applies to both professionals and individual customers. Leblanc illuminations is affiliated to Ecosystem for the management of light bulbs.

Tax on other electrical products :

The tax applies to retailers who sell to individual customers as well as professionals. However, it does not apply to professionals who take charge of recycling end-of-life products. The latter must send written confirmation to Leblanc Illuminations. For other electrical products, Leblanc Illuminations is affiliated to Ecologic and Corepile.

Design & Execution:

Communication & Design Dpt. | Leblanc illuminations 10.2024 | www.leblanc-illuminations.com

6-8 rue Michaël Faraday 72027 Le Mans Cedex 2 France

Standard | Tél. +33 (0)2 43 61 43 61 - Fax. +33 (0)2 43 86 60 20

Export Dpt. | Ph. +33 (0)2 43 61 43 54 - Fax. +33 (0)2 43 61 43 75

SAS with a 7 938 000 € capital - SIRET 482 323 649 000 20 - APE 2740Z - RCS 482 323 649 - FR 37 482 323 649

Photos credits:

Adrien Basse-Cathalinat, Antoine Barbot, Antonin Stephany, Artistic Holiday Design, Banso, Brasserie Mirmoza, Bruno Warion, CSI, Cyril Garrabos, David Meyer, David Piolé, Domaine de l'Épau, Facebook Live Rigal, Fédération Française de Ski, Francis Vachon, G. Ellis, Gala Lights, Gilles Auterocche, Hélène Villain, HiteSS Bonaire, JFU, Laetitia Rouxel, Laurent Cornu, Laurent Pascal, LB photo, Leblanc illuminations, Les Blouses Roses, Lustica Bay Luxury Resort, Maftex, Mairie de Megève, Michel Petit, Nicolas Baleizao, Pact Solutions, Pascal Lecoeur, Patrick Valleau, Philippe Bréchet, Renaud Wailliez, SBO, Sébastien Target, Thierry Vincent, Twinkly, Ville du Mans, Viviane Hervieux.

Adobe stock : Abby, bbsferrari, Bogdan Lazar, Dawid, Errant_Alien, Errant_Alien, Grispb, Irakite, J. Duquette, JFBRUNEAU, jmillan, Kate, lorenza62, Mikhail Markovskiy, olezzo, Smileus, Uwe Kantz, Volker. Shutterstock : Alewtincka. Unsplash: Vitali Adutskevich. Pexels: Jonathan Borba.

Some content, text or images, can be generated or modified by an AI. Non contractual pictures & documents. All our decorations are protected by patents at INPI & OMPI. All specifications relative to the decorations are provided for information only and may be revised. Any reproduction, whole or partial, of the catalogue is prohibited.

















Printed in France by ITF, Imprim'vert® certified, a mark of its commitment to reducing the impact of its business activity on the natural environment. This catalogue is printed on paper sourced from sustainably managed forests.



We are proud to be the most certified company in our sector!

PICTOGRAMS CAPTION

-  Connectable 230V Plug & Light
-  Connectable 24V Plug & Light
-  DMX changing colour
-  Optima range
-  Steady
-  Glittering
-  Flash / Crackling
-  Chasing
-  Flame effect
-  Confetti effect
-  Latest generation SMD LED
-  Indoor only
-  International Protection
-  LED colour
-  Cable colour



www.leblanc-illuminations.com
international@leblanc-illuminations.com
contact@leblanc-illuminations.com



220238

